

Kawasaki KZ650-F1 Parts List











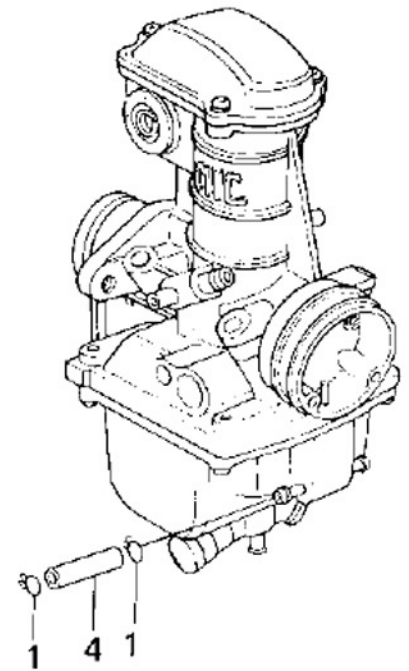
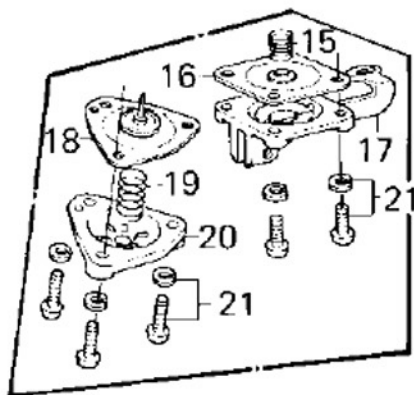
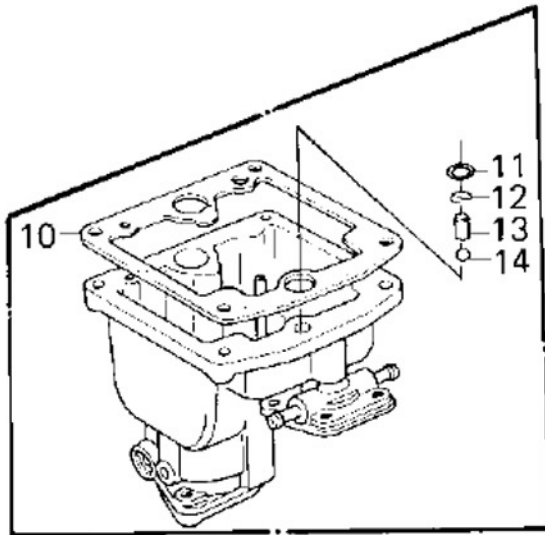
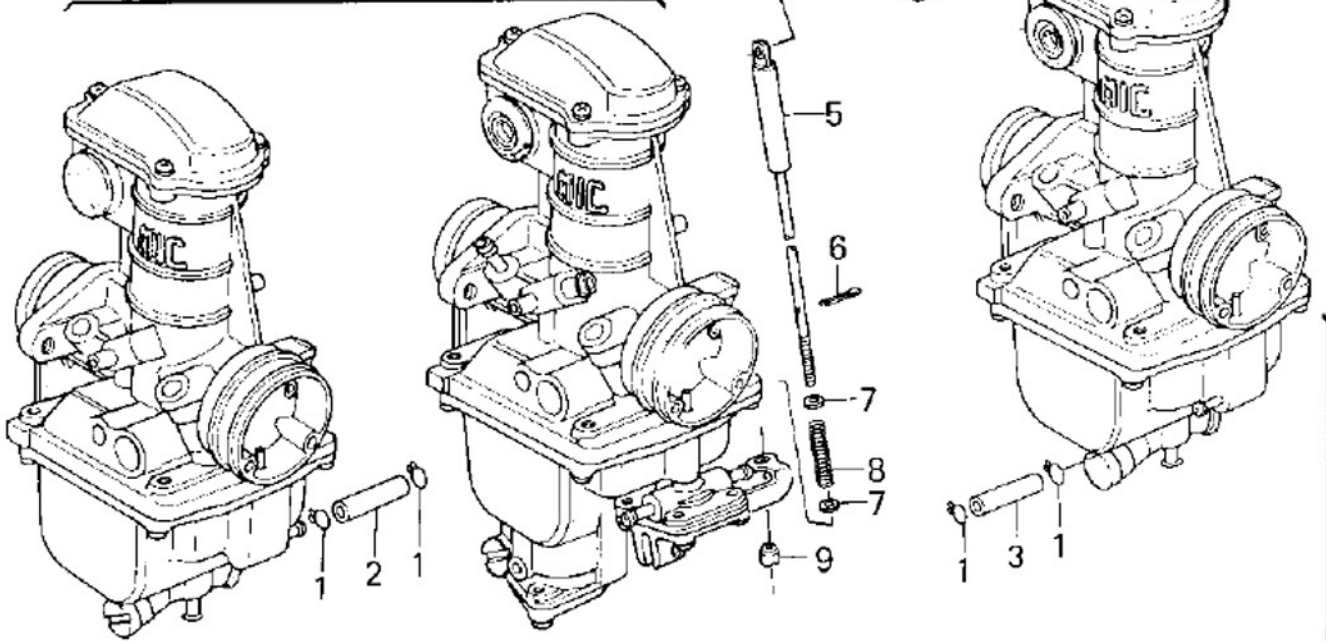



ACCELERATOR PUMP (USA)
AIR CLEANER
BATTERY CASE/TOOL CASE
BRAKE PEDAL/TORQUE LINK
BREATHER COVER/OIL PAN
CABLES
CAMSHAFTS/CHAIN/TENSIONER
CARBURETOR ASSY
CARBURETOR PARTS
CHASSIS ELECTRICAL EQUIPMENT
CLUTCH
CRANKCASE
CRANKCASE BOLT & STUD PATTERN
CRANKSHAFT
CYLINDER HEAD
CYLINDER HEAD COVER
CYLINDER/PISTONS
ENGINE COVERS
FENDERS
FOOTRESTS
FRAME
FRAME FITTINGS
FRONT BRAKE
FRONT FORK
FRONT MASTER CYLINDER
FRONT WHEEL/HUB
FUEL TANK
GEAR CHANGE DRUM & FORKS
GEAR CHANGE MECHANISM
GENERATOR/REGULATOR
HANDLEBAR
HEADLIGHT
IGNITION
IGNITION SWITCH/LOCKS/REFLECTORS
KICKSTARTER MECHANISM
LABELS
METERS
MUFFLERS
OIL PUMP/OIL FILTER
OWNER TOOLS
REAR WHEEL/HUB/BRAKE/CHAIN
SEAT/SEAT COVER
SECONDARY SHAFT
SIDE COVERS/CHAIN COVER
SPECIAL SERVICE TOOLS "A"
SPECIAL SERVICE TOOLS "B"
STANDS
STARTER MOTOR/STARTER CLUTCH
SWING ARM/SHOCK ABSORBERS
TAILLIGHT
TIRES
TRANSMISSION
TURN SIGNALS
VALVES

FRONT

Ref. Carburetor Assy

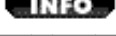
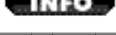
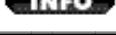
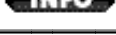
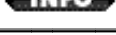
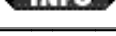
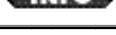
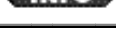
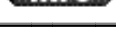
Ref. Carburetor Assy

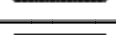
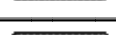



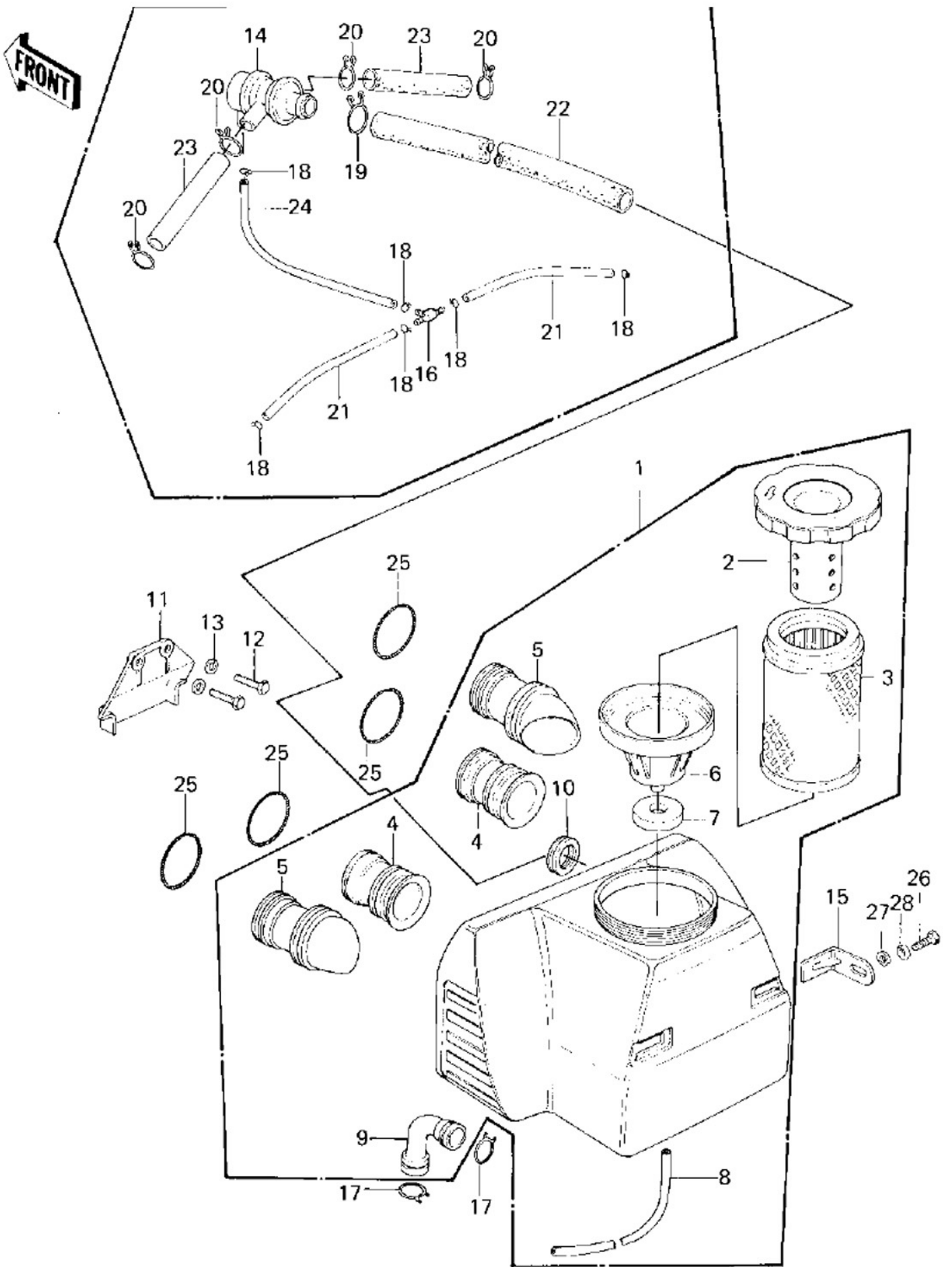



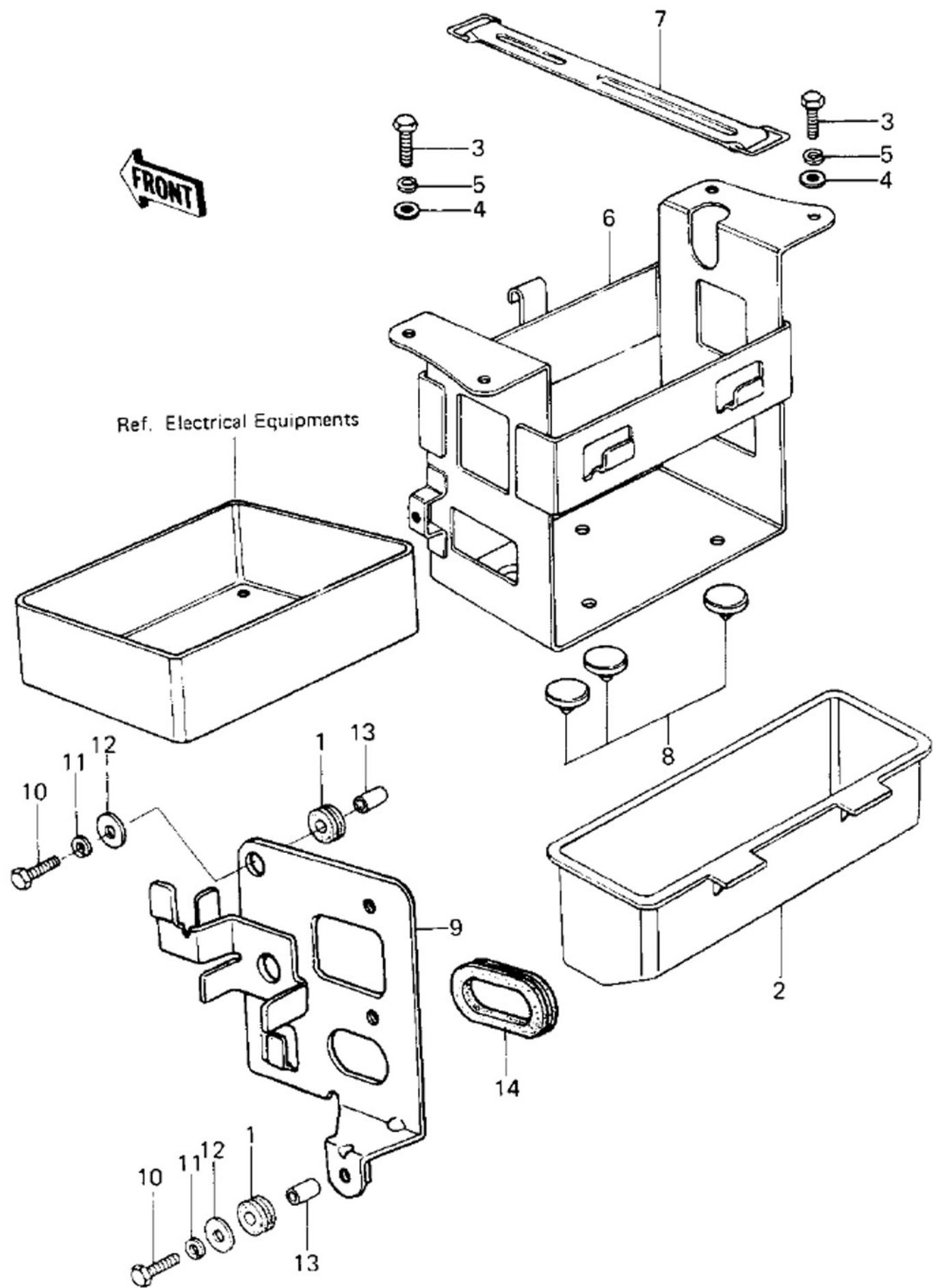







Ref #	Part #	Description	Qty	Spec Code
1	92037-1124 	CLAMP,TUBE	6	
2	92059-1072 	TUBE,3.5X7.5X47.5	1	
3	92059-1071 	TUBE,3.5X7.5X64.5	1	
4	92059-1072 	TUBE,3.5X7.5X47.5	1	
5	46102-1007 	ROD ASSY,PUMP	1	
6	550D1006 	COTTER PIN,1.0X6	1	
7	92022-1138 	WASHER,PUMP ROD	2	
8	92081-1138 	SPRING,PUMP ROD	1	
9	92015-1075 	NUT,PUMP ROD	1	
10	11009-1562 	GASKET,FLOAT CHAMBER	4	
11	92055-1059 	"O" RING,CHECK VALVE	4	
12	92037-1123 	CLAMP,SPRING,CHECK VL	4	
13	13042-1004 	WEIGHT,PUMP,CHECK VLV	4	
14	92140-1003 	BALL,STEEL,CHECK VALV	4	
15	92081-1139 	SPRING,PUMP DIAPHRAGM	1	
16	43028-1012 	DIAPHRAGM,PUMP	1	
17	14025-1139 	COVER ASSY,PUMP	1	
18	43028-1010 	DIAPHRAGM,SENSOR	1	
19	92081-1137 	SPRING,SENSOR DIAPHRA	1	
20	14025-1121 	COVER,SENSOR	1	
21	223B0414 	SCREW-PAN-WS-CROS	7	











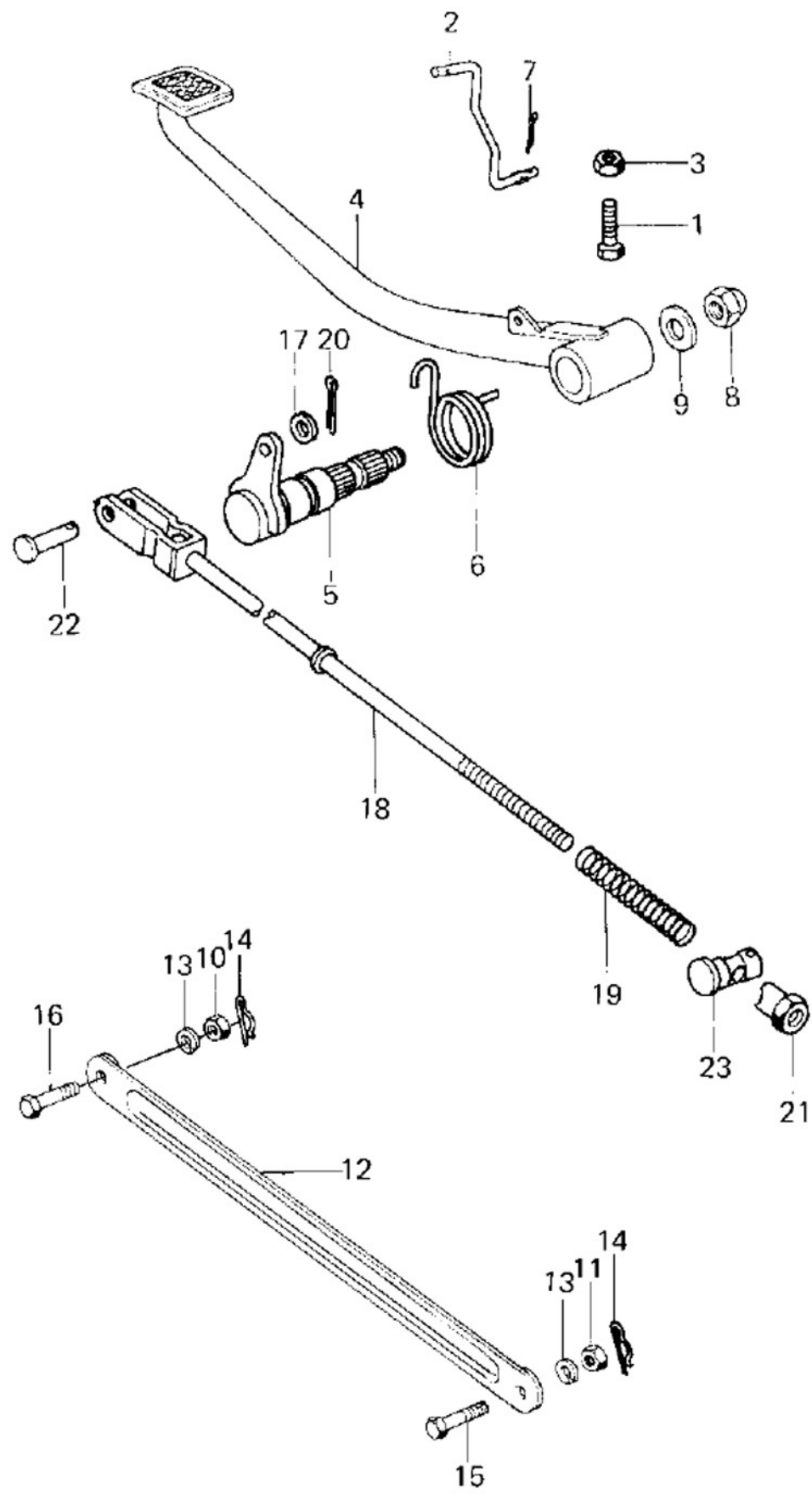









Ref #	Part #	Description	Qty	Spec Code
1	11010-1078 	FILTER-ASSY-AIR	1	
1	11010-1079 	FILTER-ASSY	1	
2	11012-069 	CAP,AIR CLEANER	1	
3	11013-1006 	ELEMENT,AIR CLNR	1	
4	11015-057 	INLET DUCT,#2,3	2	
5	11015-063 	INLET PIPE,#1.4	2	
6	11033-006 	HOLDER,INLET PIPE	1	
7	11039-003 	GASKET,HOLDER	1	
8	700Q6200 	TUBE, VINYL, 6X200	1	
9	92059-137 	TUBE,BREATHER	1	
10	92071-1013 	GROMMET,AIR CLEANER	1	
11	11019-003 	BAFFLE PLT,AIR CLEANER	1	
12	112G0618 	BOLT-UPSET	2	
13	411B0600 	WASHER PLAIN 6MM	2	
14	16126-1005 	VALVE ASSY,AIR SWITCH	1	
15	32070-038 	BRACKET,AIR CLEANER	2	
16	92005-1017 	FITTING,TUBE	1	
17	92037-028 	CLAMP BREATHER PIPE	2	
18	92037-072 	CLAMP-PIPE	6	
19	92037-1076 	CLAMP	1	
20	92037-213 	CLAMP,BREATHER TUBE	4	
21	92059-1162 	TUBE,VACUUM,LONG	2	
22	92059-1041 	TUBE,19X25X415	1	
23	92059-1042 	TUBE,14X20X100	2	
24	92059-1043 	TUBE,4X9X290	1	
25	92081-047 	SPRING COIL	4	
26	112G0612 	BOLT-UPSET,6X12	2	
27	411B0600 	WASHER PLAIN 6MM	2	
28	461F0600 	WASHER SPRING 6MM	2	



Ref #	Part #	Description	Qty	Spec Code
1	92075-317 	DAMPER	2	
2	32098-028 	CASE,TOOL	1	
3	112G0612 	BOLT-UPSET,6X12	4	
4	410B0600 	WASHER PLAIN 6MM	4	
5	461F0600 	WASHER SPRING 6MM	4	
6	32097-1005 	CASE,BATTERY	1	
7	92072-054 	BAND,OIL TANK	1	
8	92075-078 	DAMPER RUBBER	3	
9	11036-1089 	BRACKET,ELECTRO BASE	1	
10	110B0625 	BOLT, HEX HEAD, 6X25	2	
11	461F0600 	WASHER SPRING 6MM	2	
12	92022-228 	WASHER,PLAIN,7MM	2	
13	92027-291 	COLLAR-CLAMP	2	
14	92071-1007 	GROMMET,ELECTO BASE	1	

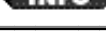

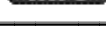
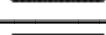
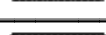
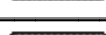





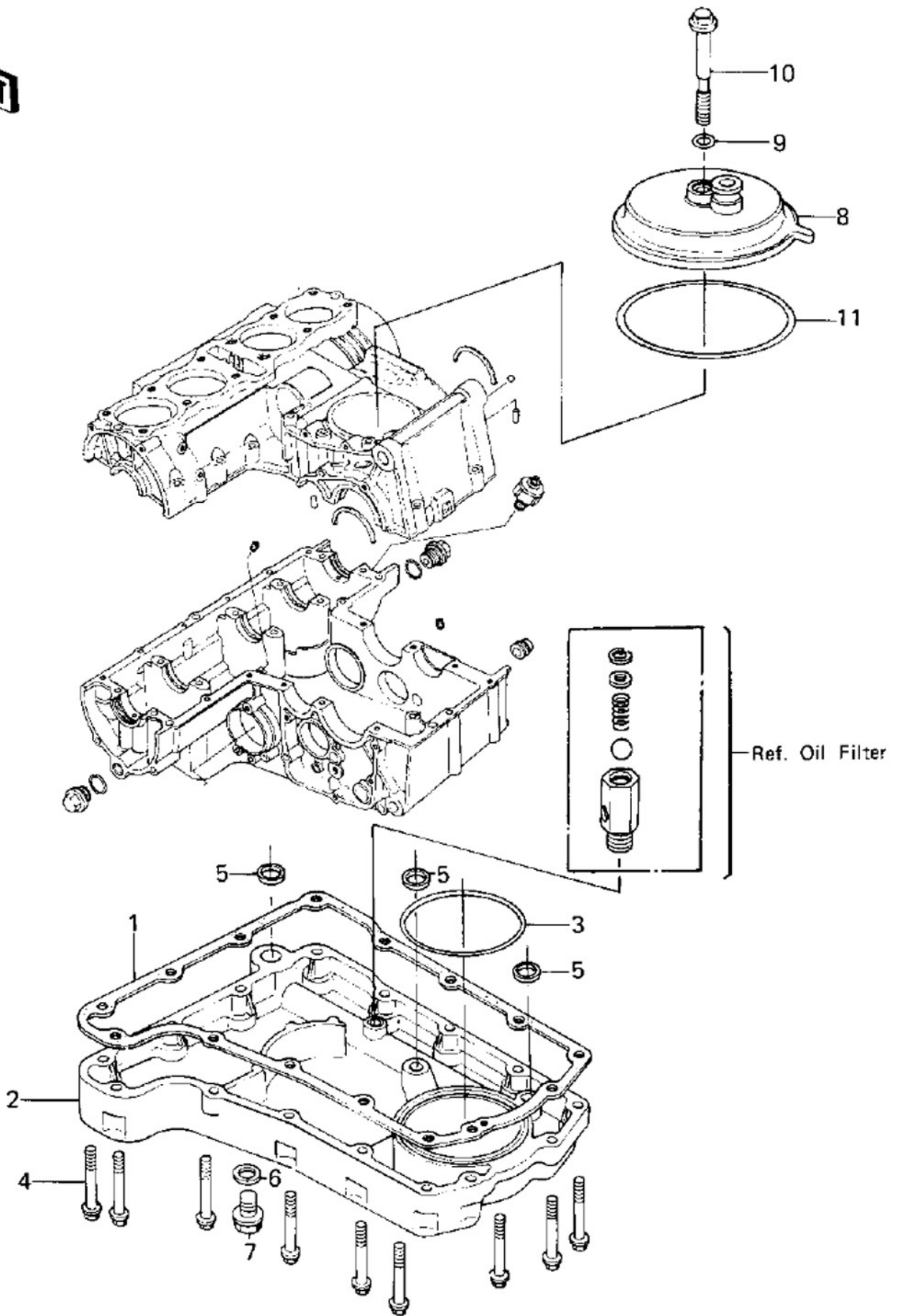

FRONT









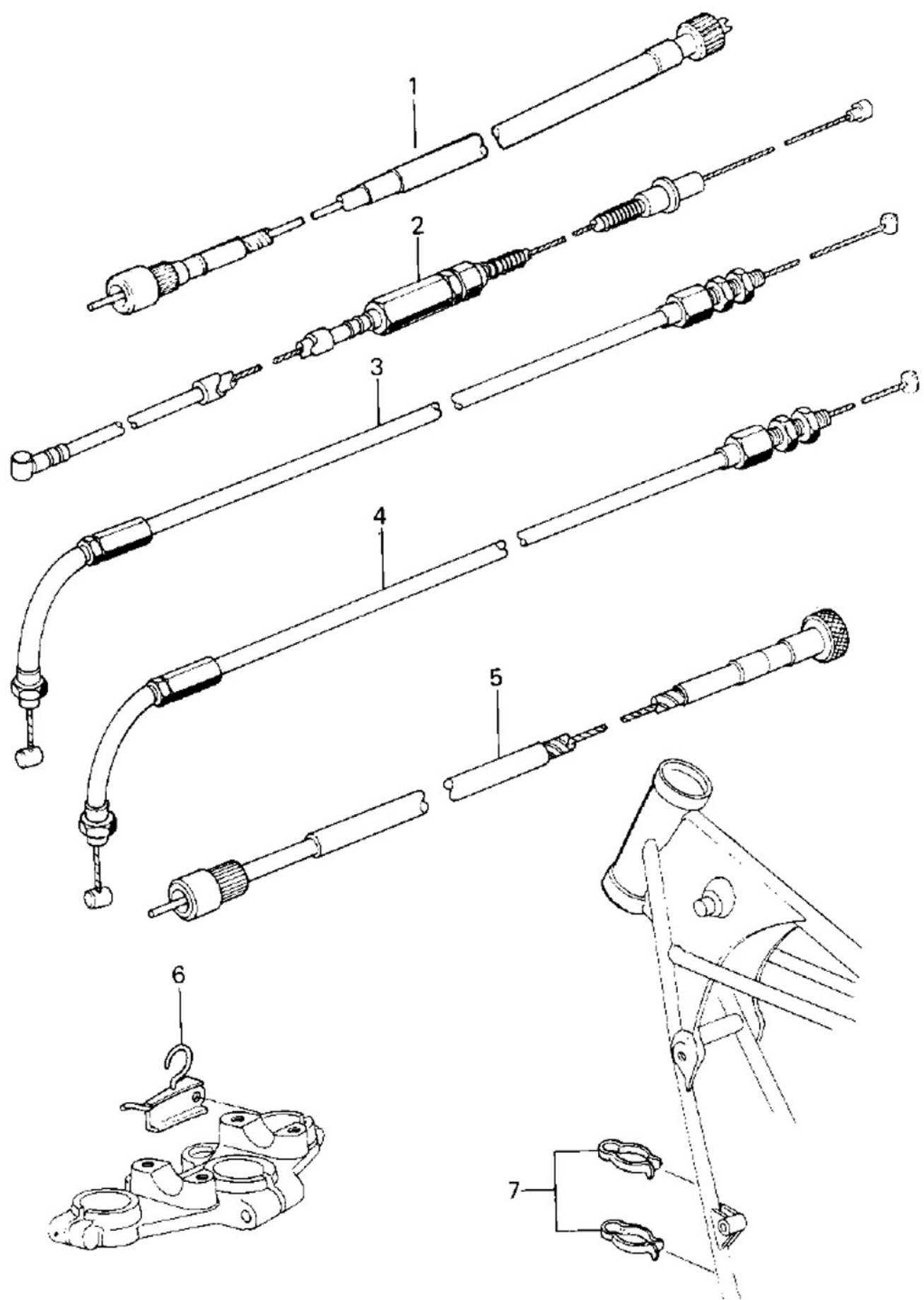

Ref #	Part #	Description	Qty	Spec Code
1	112G0620 	BOLT-UPSET,6X20	1	
2	27012-1003 	HOOK, BRAKE SWITCH	1	
3	311B0600 	NUT 6MM	1	
4	43001-1009 	PEDAL BRAKE	1	
5	43004-012 	SHAFT,BRAKE PEDAL	1	
6	43005-022 	SPRING,BRAKE PEDAL	1	
7	550D1610 	PIN COTTER 1.6X10	1	
8	92019-013 	NUT,CAP AND LOCK,8MM	1	
9	92022-1561 	WASHER,8.5X20X1.6	1	
10	314B1000 	NUT,10MM	1	
11	315B1000 	NUT 10MM	1	
12	43007-027 	TORQUE LINK-REAR BRK	1	
13	461F1000 	WASHER SPRING 10MM	2	
14	554A0800 	PIN,SNAP	2	
15	92003-034 	BOLT HEX HEAD 10MM	1	
16	92003-096 	BOLT	1	
17	410B0600 	WASHER PLAIN 6MM	1	
18	43011-009 	ROD-BRAKE	1	
19	43012-001 	SPRING,BRAKE ROD	1	
20	550D2015 	PIN COTTER 2.0X15	1	
21	92015-042 	NUT-BRAKE ROD ADJUST	1	
22	92043-064 	PIN-BRAKE ROD FITTING	1	
23	92043-065 	PIN-BRAKE ROD	1	

FRONT











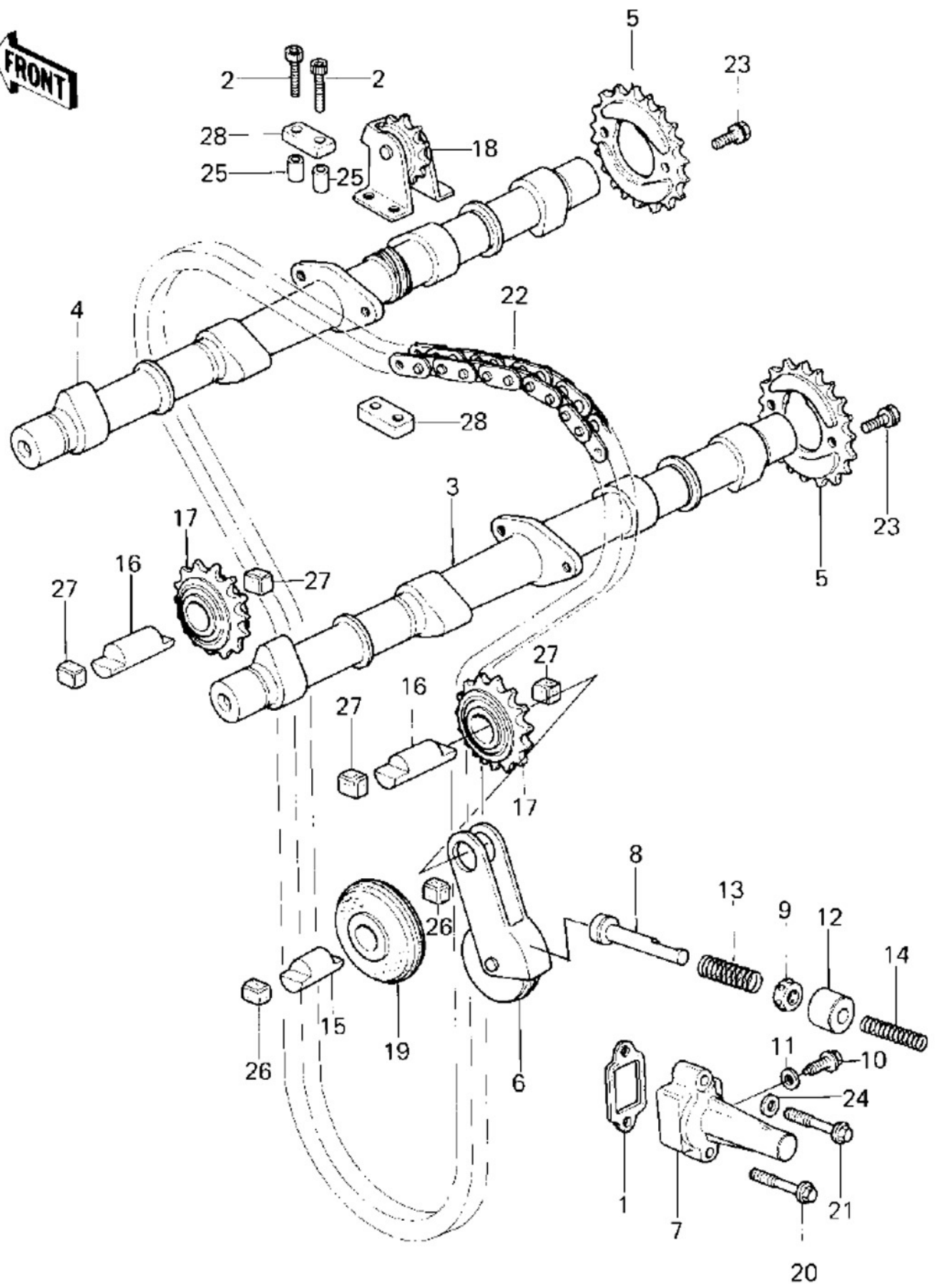

















Ref #	Part #	Description	Qty	Spec Code
1	11009-1983 	GASKET,OIL PAN	1	
2	49034-5011 	PAN-OIL	1	
3	671B2590 	"O" RING,90MM	1	
4	130G0625 	BOLT,FLANGED,6X25	15	
5	92055-077 	"O" RING	3	
6	92065-097 	GASKET,DRIN PLUG	1	
7	92066-1174 	PLUG,OIL DRAIN,12X15	1	
8	14070-1008 	BODY-BREATHER	1	
9	670B1508 	"O" RING,8MM	1	
10	92003-107 	BOLT,HEX HEAD,8X72	1	
11	92055-052 	"O" RING,91MM	1	



Ref #	Part #	Description	Qty	Spec Code
1	54001-1012 	CABLE,SPEEDOMETER	1	
2	54011-087 	CABLE,CLUTCH	1	
3	54012-140 	CABLE,THROTTLE CON,OP	1	
4	54012-141 	CABLE,THROTTLE CON CL	1	
5	54018-1003 	CABLE,TACHOMETER	1	
6	92037-104 	CLAMP,CABLE	1	
7	92037-093 	CLAMP,CABLE	2	

FRONT







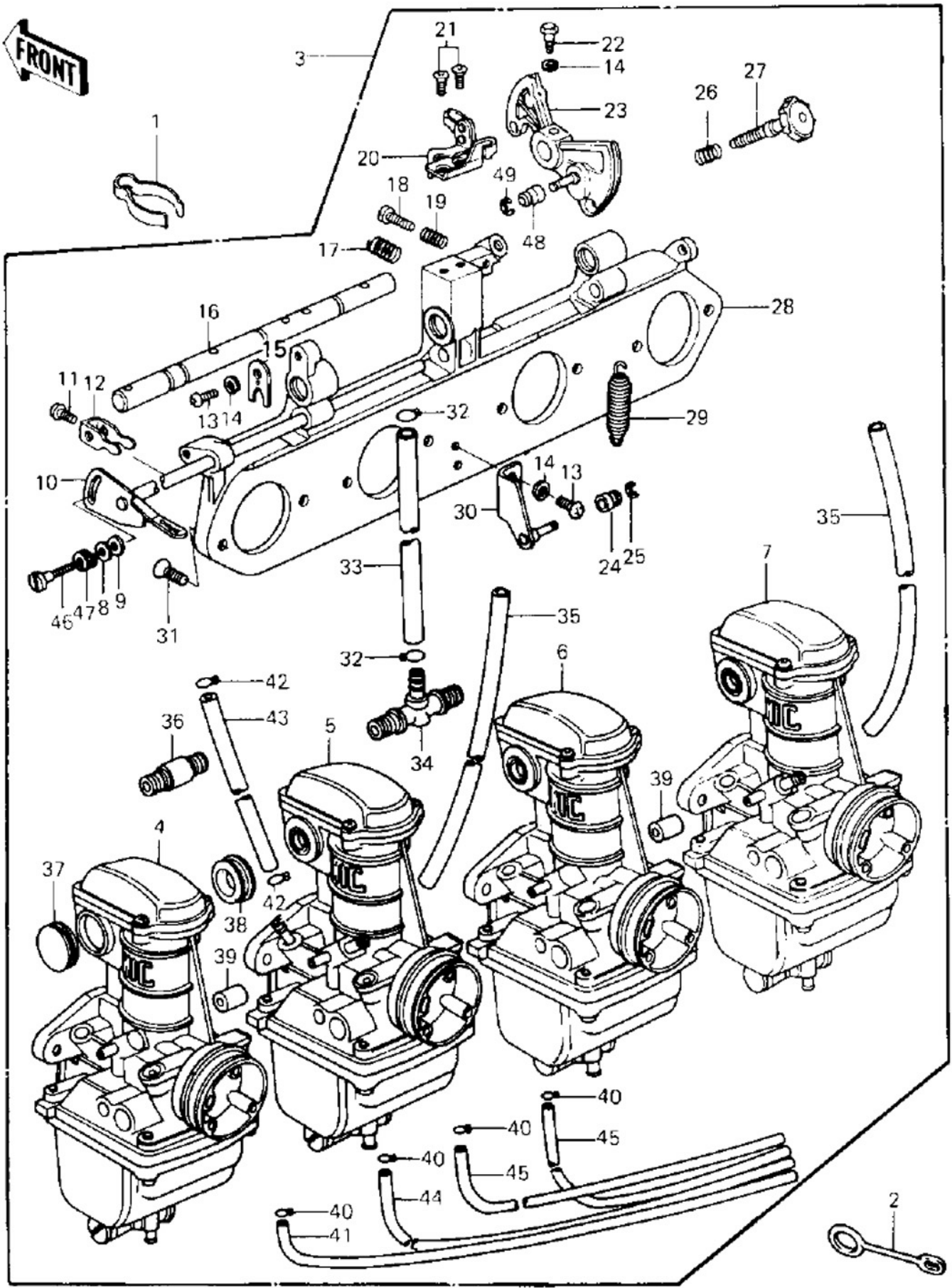





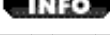

Ref #	Part #	Description	Qty	Spec Code
1	11009-1980 	GASKET,TENSIONER	1	
2	120Q0632 	BOLT, SOCKET, 6X32	4	
3	12044-012 	CAM SHAFT,INLET	1	
4	12044-013 	CAM SHAFT,EXHAUST	1	
5	12046-004 	SPROCKET,CAM	2	
6	12048-015 	TENSIONER,CAM CHAIN	1	
7	99996-1021 	TENSIONER KIT	1	
8	13116-1008 	ROD ASSY,PUSH	1	
9	14020-1002 	RETAINER	1	
10	92001-1155 	BELT,TENSIONER ADJUST	1	
11	92022-077 	WASHER OIL PUMP BANJO	1	
12	92027-1102 	COLLAR, TENSIONER	1	
13	92081-1068 	SPRING,TENSIONER	1	
14	92081-146 	SPRING	1	
15	12052-003 	SHAFT,CAM CHAIN GUIDE	1	
16	12052-005 	SHAFT,GUIDE ROLLER	2	
17	12053-1012 	IDLER ASSY,CAM CHAIN	2	
18	12053-1013 	IDLER ASSY,CAM CHAIN	1	
19	12055-004 	ROLLER,CAM CHN GUIDE	1	
20	130G0630 	BOLT,FLANGED,6X30	1	
21	130H0635 	BOLT,FLANGED,6X35	1	
22	21070-012 	CHAIN,CAM	1	
23	92003-208 	BOLT,SPROCKET FITTING	4	
24	92022-077 	WASHER OIL PUMP BANJO	1	
25	92027-1079 	COLLAR,8X15	4	
26	92075-123 	DAMPER RUBBER	2	
27	92075-232 	RUBBER,GUIDE ROLLAR	4	
28	92075-289 	DAMPER RUBBER	4	

FRONT

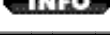
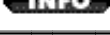
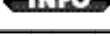
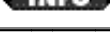
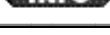
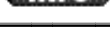
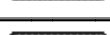

F









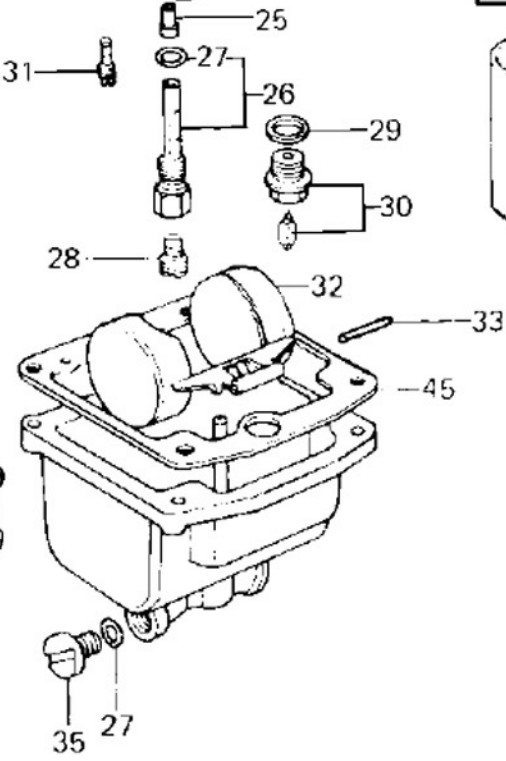
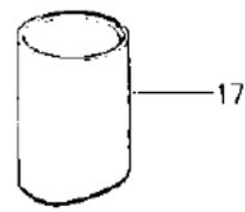
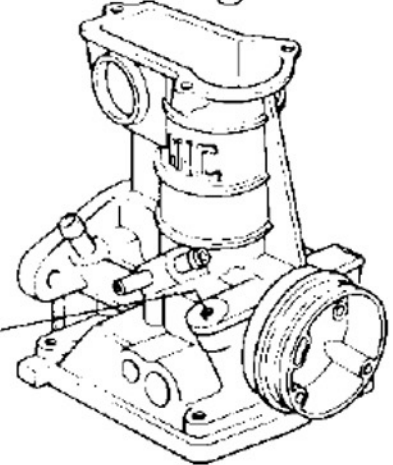
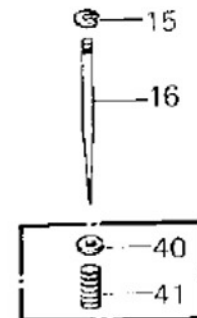
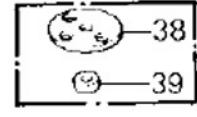
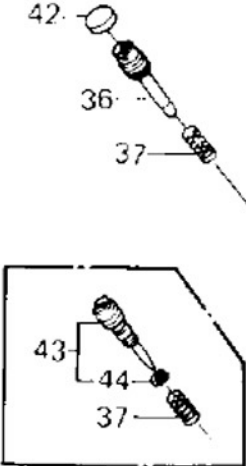
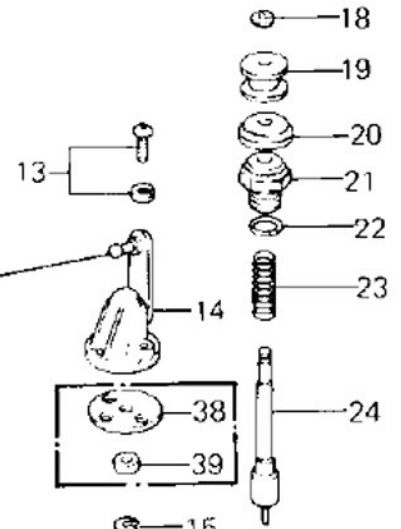
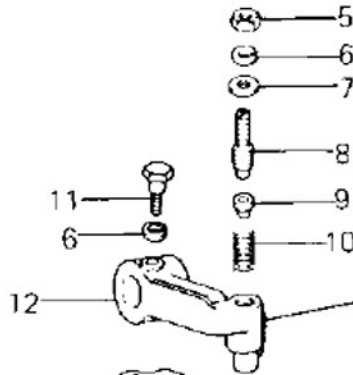



















I

Ref #	Part #	Description	Qty	Spec Code
1	92037-1092 	CLAMP,AIR VENT HOSE	1	
2	92037-134 	CLAMP,OVER FLOW PIPE	1	
3	16001-1208 	CARBURETOR ASSY	1	
3	16001-1069 	CARBURETOR ASSY	1	
4	16001-1070 	CARBURETOR,L.H,OUT	1	
5	16001-1071 	CARBURETOR,L.H,INSIDE	1	
6	16001-1072 	CARBURETOR,R.H,INSIDE	1	
7	16001-1073 	CARBURETOR,R.H,OUT	1	
8	410B0500 	WASHER PLAIN 5MM	1	
9	16039-019 	WASHER,PLAIN	1	
10	16041-021 	SHAFT,STARTER PLUNGER	1	
11	16046-007 	SCREW,PAN HEAD,5X7	4	
12	13168-1026 	LEVER,STARTER PLUNGER	3	
13	220B0514 	SCREW-PAN-CROS	4	
14	461F0500 	WASHER SPRING 5MM	1	
15	16055-012 	PLATE,SHAFT STOPPER	1	
16	16041-017 	SHAFT,CARB CONNECTION	1	
17	16040-022 	SPRING,CABLE PULLY	1	
18	16021-032 	SCREW	1	
19	16022-010 	SPRING,THROTTLE ADJST	1	
20	16077-017 	BRACKET,THROTTLE CABL	1	
21	221B0510A 	SCREW CNTSNK HD 5X10	2	
22	16067-006 	BOLT,HEX HEAD,5X14	1	
23	16068-015 	PULLEY,THROTTLE CABLE	1	
24	16073-016 	RING	1	
25	482K3000 	CIRCLIP 3MM	1	
26	16022-017 	SPRING,THROTTLE STOP	1	
27	16021-1010 	SCREW,THROTTLE STOP	1	
28	16065-049 	HOLDER,CARBURETOR	1	

29	92081-1028	INFO	SPRING,THROTTLE PULLY	1	
30	16077-016	INFO	BRACKET,THROTTLE CABL	1	
31	16033-029	INFO	SCREW,6X14	8	
32	92037-1184	INFO	CLAMP,HOSE	2	
33	92059-1123	INFO	TUBE,7.5X12.5X225	1	
34	92005-1010	INFO	FITTING	1	
35	92059-1045	INFO	HOSE,AIR VENT,5X8X250	2	
36	92005-1009	INFO	FITTING	2	
37	16039-042	INFO	CAP,RUBBER	2	
38	92071-104	INFO	GROMMET,CARBURETOR	6	
39	92059-141	INFO	HOSE,6X11.5X16	2	
40	92037-173	INFO	CLAMP,OVERFLOW HOSE	4	
41	92059-147	INFO	HOSE,FUEL OVERFLOW	1	
42	92037-072	INFO	CLAMP-PIPE	2	
43	92059-1019	INFO	TUBE,5.3X10.5X140	1	
44	92059-134	INFO	HOSE,FUEL OVERFLOW	1	
44	92059-147	INFO	HOSE,FUEL OVERFLOW	1	
45	92059-134	INFO	HOSE,FUEL OVERFLOW	2	
46	16046-005	INFO	SCREW	1	
47	16040-009	INFO	SPRING,F	1	
48	16073-016	INFO	RING	1	
49	482K3000	INFO	CIRCLIP 3MM	1	

FRONT



Ref #	Part #	Description	Qty	Spec Code
1	16005-027 	TOP,MIXING CHAMBER	4	
2	223B0414 	SCREW-PAN-WS-CROS	12	
3	461F0400 	WASHER SPRING 4MM	16	
4	16019-031 	GASKET,CHAMBER TOP	4	
5	16003-013 	NUT,5MM	4	
6	461F0500 	WASHER SPRING 5MM	8	
7	16039-016 	WASHER,PLAIN	4	
8	16046-012 	SCREW,SLOTTED	4	
9	16057-002 	SEAT,SPRING	4	
10	16040-026 	SPRING	4	
11	16067-006 	BOLT,HEX HEAD,5X14	4	
12	39075-1001 	LEVER,THROTTLE	4	
13	16033-031 	SCREW,PAN HEAD,3X14	8	
14	39184-1001 	BRACKET,THROTTLE VALV	4	
14	16007-028 	BRACKET,THROTTLE VALV	4	
15	16008-010 	CIRCLIP	4	
16	16009-1048 	JET NEEDLE,5CL30	4	
16	16009-1013 	JET NEEDLE,5CN15	4	
17	16025-1025 	VALVE,THROTTLE,CA1.75	4	
17	16025-1006 	VALVE,THROTTLE	4	
18	16076-003 	CIRCLIP	4	
19	16073-014 	COLLAR	4	
20	16039-015 	CAP,STARTER PLUNGER	4	
21	16012-015 	CAP,STARTER PLUNGER	4	
22	670B1509 	"O" RING,9MM	4	
23	16013-008 	SPRING,STARTER PLUG	4	
24	16016-021 	PLUNGER,STARTER	4	
25	16017-1034 	NEEDLE JET,AO-5	4	
25	16017-1021 	NEEDLE JET,0-4	4	

26	49122-1006	INFO	PIPE,BLEED	4	
26	16047-005	INFO	PIPE,BLEED	4	
27	16038-016	INFO	"O" RING,MAIN JET COV	8	
28	92063-1035	INFO	MAIN JET,#A97.5R	4	
28	92063-1028	INFO	MAIN JET,#A102.5	4	RACING USE ONLY
28	92063-1033	INFO	MAIN JET,#A100	4	RACING USE ONLY
28	92063-1042	INFO	MAIN JET,#A105R	4	RACING USE ONLY
28	92063-068	INFO	MAIN JET NO 92.5R	4	RACING USE ONLY
28	92063-1031	INFO	MAIN JET,#A95	4	RACING USE ONLY
29	16029-004	INFO	WASHER FLOAT VLV SEAT	4	
30	16030-1001	INFO	FLOAT VALVE ASSY	4	
31	92064-1018	INFO	PILOT JET,#A15	4	
32	16031-031	INFO	FLOAT	4	
33	16032-003	INFO	FLOAT PIN	4	
34	220B0416	INFO	SCREW PAN HEAD 4X16	16	
35	16049-007	INFO	SCREW,GUIDE	4	
36	16014-1020	INFO	SCREW,PILOT ADJUSTING	4	
37	16022-007	INFO	SPRING-THR STOP SCREW	4	
38	13169-1107	INFO	PLATE,JET NEEDLE	4	
39	92027-1103	INFO	RING,JET NEEDLE	4	
40	92022-1024	INFO	WASHER,THROTTLE VALVE	4	
41	92081-1072	INFO	SPRING,JET NEEDLE	4	
42	92066-1051	INFO	PLUG,PILOT SCREW	4	
43	16014-1006	INFO	SCREW,AIR ADJUSTING	4	
44	16038-022	INFO	"O" RING	4	
45	11009-1563	INFO	GASKET,FLOAT CHAMBER	4	



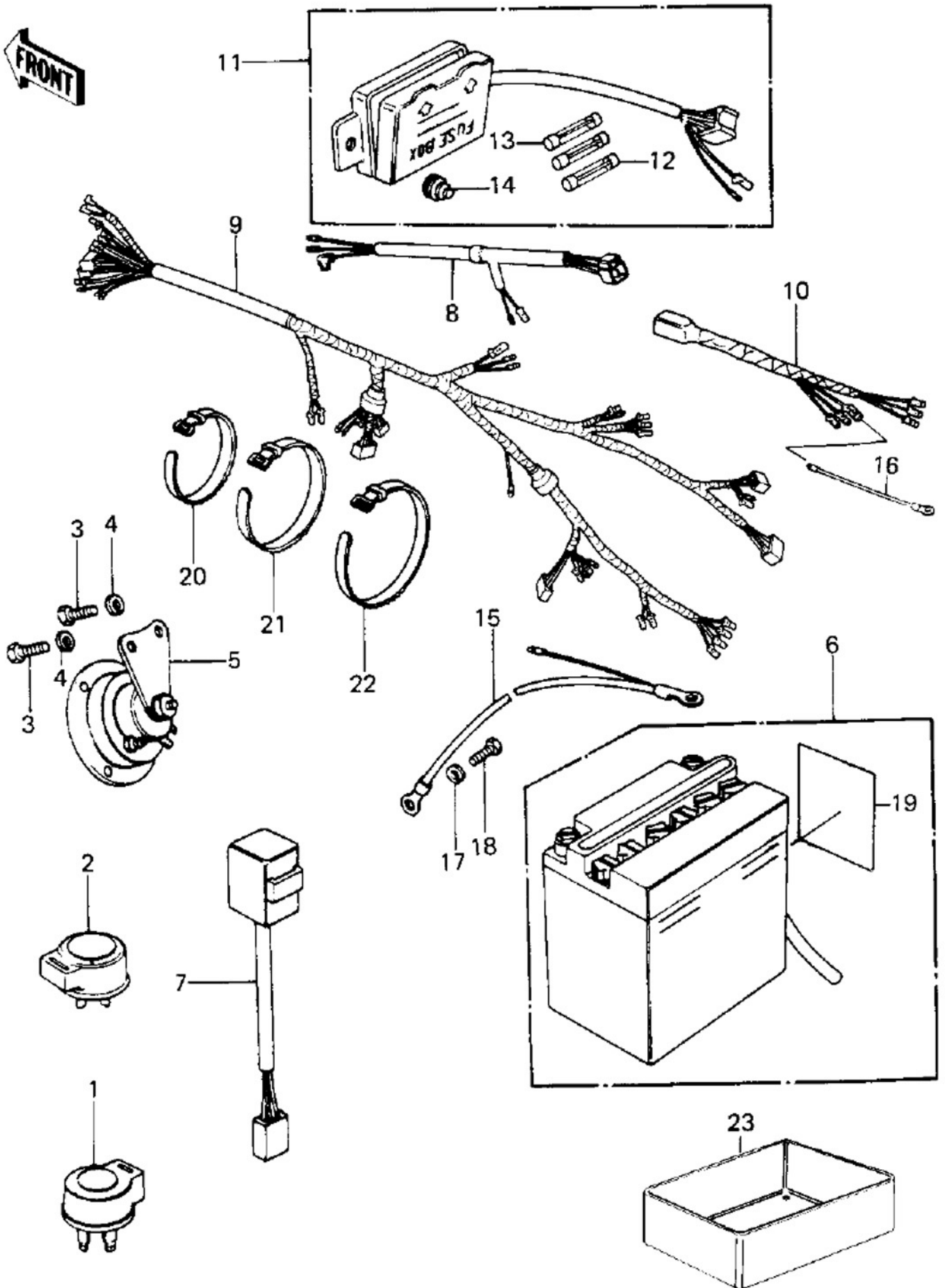





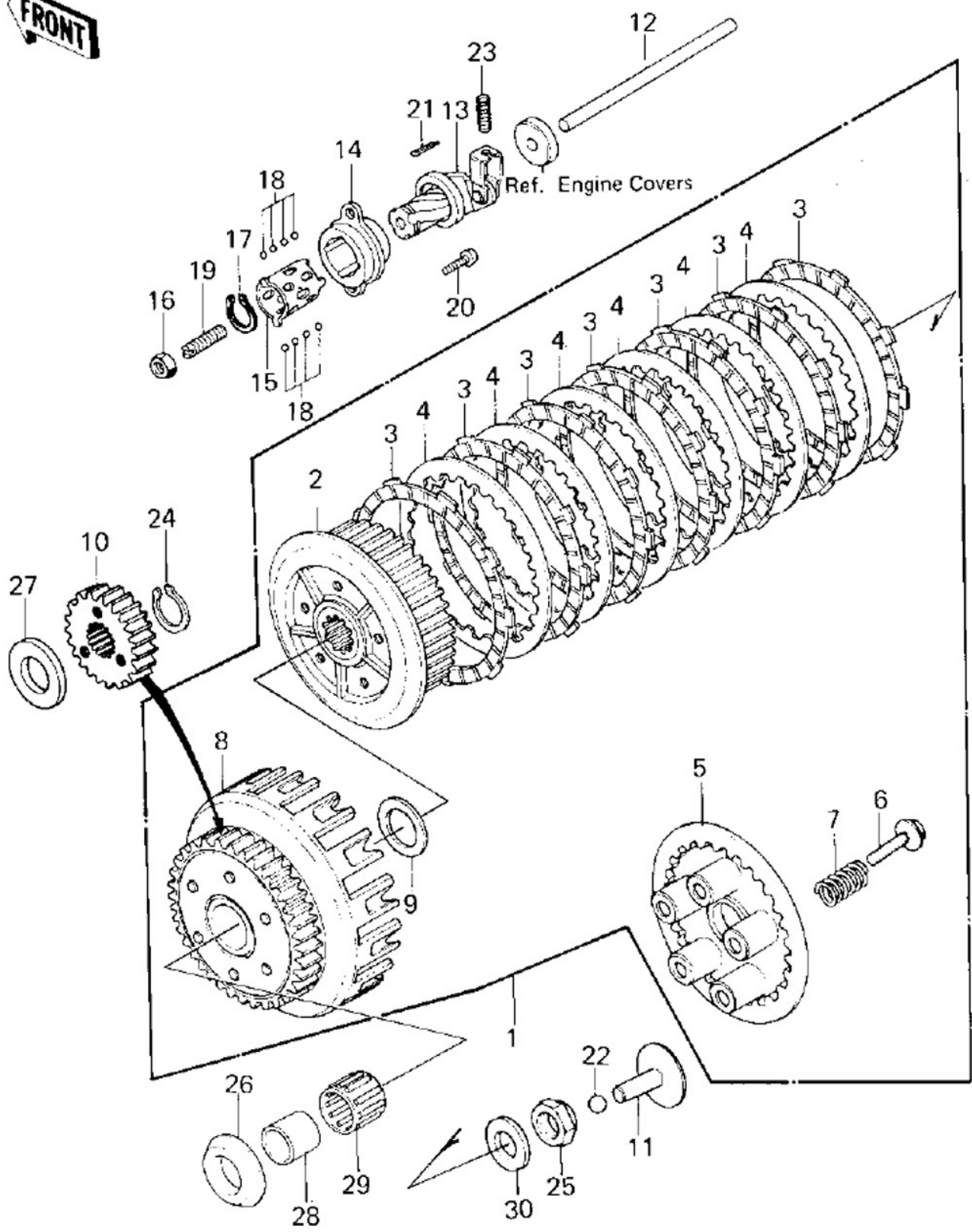

FRONT











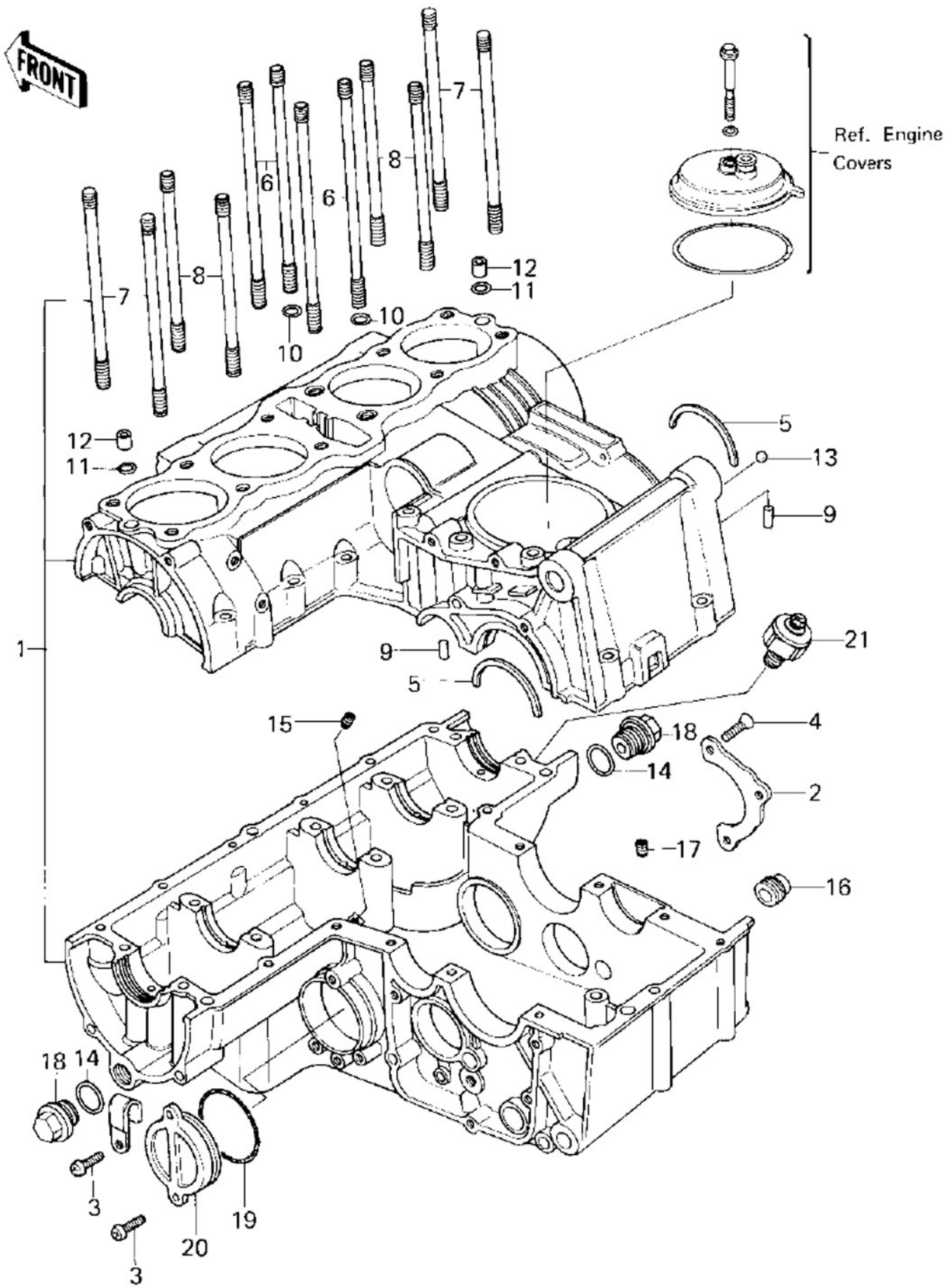













Ref #	Part #	Description	Qty	Spec Code
1	27002-011 	RELAY-TURN SIGNAL	1	
2	27002-016 	RELAY,TURN SIGNAL	1	
3	115G0816 	BOLT-SMALL-UPSET,8X16	2	
4	461F0800 	WASHER SPRING 8MM	2	
5	27003-076 	HORN	1	
6	26012-1010 	BATTERY 12V11AH W/LA	1	
7	28019-001 	SWITCH,OUTAGE,INDICTR	1	
8	26001-1022 	HARNESS,CENTER	1	
9	26001-1131 	HARNESS,MAIN	1	
10	26002-063 	WIRING HARNESS,REAR	1	
11	26004-1002 	FUSE ASSY	1	
12	26006-003 	FUSE 10A	3	
13	26006-005 	FUSE-20A	2	
14	92075-279 	DAMPER RUBBER,FUSE	1	
15	26010-049 	WIRE,BATTERY GROUND	1	
16	26011-063 	LEAD WIRE,SIGNAL LAMP	2	
17	461F0600 	WASHER SPRING 6MM	1	
18	92001-137 	BOLT,HEX HEAD,6MM	1	
19	56040-1036 	LABEL-WARNING,BATTERY	1	
20	92072-030 	BAND,SHORT	4	
21	92072-031 	BAND,MIDDLE	1	
22	92072-056 	BAND,WIRING HARNESS	4	
23	32099-015 	CASE,BATTERY	1	

FRONT



Ref #	Part #	Description	Qty	Spec Code
1	13081-1043 	CLUTCH-ASSY	1	E/NO. 114501~118237
1	13081-1043 	CLUTCH-ASSY	1	E/NO. 118238~123772
2	13087-043 	HUB,CLUTCH	1	
3	13088-030 	PLATE,CLUTCH FRICTION	7	
4	13089-022 	PLATE,CLUTCH STEEL	6	
5	13187-006 	PLATE,CLUTCH SPRING	1	
6	92001-1066 	BOLT,CLUTCH SPR FITT	5	
7	92081-1033 	SPRING,CLUTCH	5	
8	13095-1022 	HOUSING,CLUTCH	1	E/NO. 114501~118237
8	13095-1022 	HOUSING,CLUTCH	1	E/NO. 118238~123772
9	92026-022 	WASHER TH 25.5X47X2.5	1	
10	13121-037 	GEAR,2ND SHAFT,29T	1	
11	13116-022 	PUSHER,CLUTCH SPRG PL	1	
12	13116-035 	ROD,CLUTCH PUSH	1	E/NO. 114501~118403
12	13116-1007 	ROD,CLUTCH PUSH	1	E/NO. 118404~123772
13	13102-027 	INNER,CLUTCH RELEASE	1	
14	13118-011 	OUTER,CLUTCH RELEASE	1	
15	13197-004 	RETAINER	1	
16	318B0800 	NUT 8MM	1	
17	480J1500 	CIRCLIP 15MM	1	
18	600A0400 	BALL,STEEL,1/8"	11	
19	92014-014 	SCREW,SLOTTED,8X25	1	
20	220B0616 	SCREW PAN HEAD 6X16	2	
21	550D1615 	PIN COTTER 1.6X15	1	
22	600A1200 	BALL STEEL 3/8'	1	
23	92081-069 	SPRING-CLUTCH RELEASE	1	
24	480J2200 	CIRCLIP,22MM	1	
25	92015-1555 	NUT,20MM	1	
26	92026-116 	SPACER,THRUST,T=5.5MM	1	
27	92027-263 	COLLAR,T=5MM	1	
28	92028-178 	BUSHING,CLUTCH	1	
29	92046-028 	BEARING,KTV323723	1	
30	92125-002 	WASHER	1	



Ref #	Part #		Description	Qty	Spec Code
1	14001-5046		CRANKCASE SET	1	
2	14014-1007		PLATE,POSITIONING	1	
3	220B0620		SCREW PAN HEAD 6X20	2	
4	221B0620		SCREW CNTSNK HD 6X20	1	
5	14013-004		RING BEARING SETTING	2	
6	92004-062		STUD, 10X53	4	*
7	92004-1004		STUD, 10X133	4	*
8	92004-1007		STUD, 10X116	4	*
9	92042-016		PIN, DOWEL, 6X16	2	*
10	92055-099		O RING, 8.8MM	2	*
11	670D2010		O RING, 9.8MM, CYLINDER BASE	2	
12	92062-016		NOZZLE	2	
13	92066-057		PLUG, RUBBER	1	*
14	92055-097		O RING, MAIN GALLERY	2	*
15	92062-011		NOZZLE, BLACK	1	*
16	92062-014		NOZZLE	1	*
17	92062-015		NOZZLE,SILVER	1	*
18	92066-066		PLUG, MAIN GALLERY	2	*
19	670B3046		"O" RING,46MM	1	
20	92066-1019		PLUG,SECONDARY SHAFT	1	
21	16144-006		SWITCH ASY,OIL PRSSUR	1	

Upper Case
(Outside)

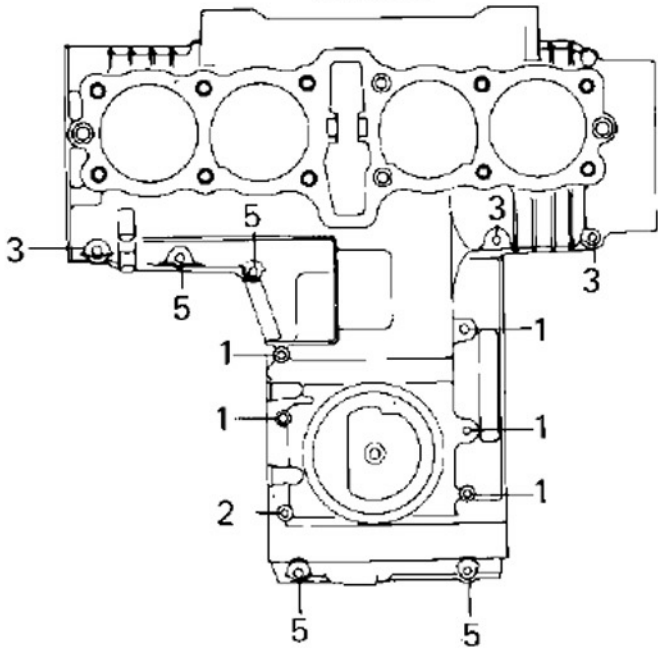

Upper Case
(Inside)

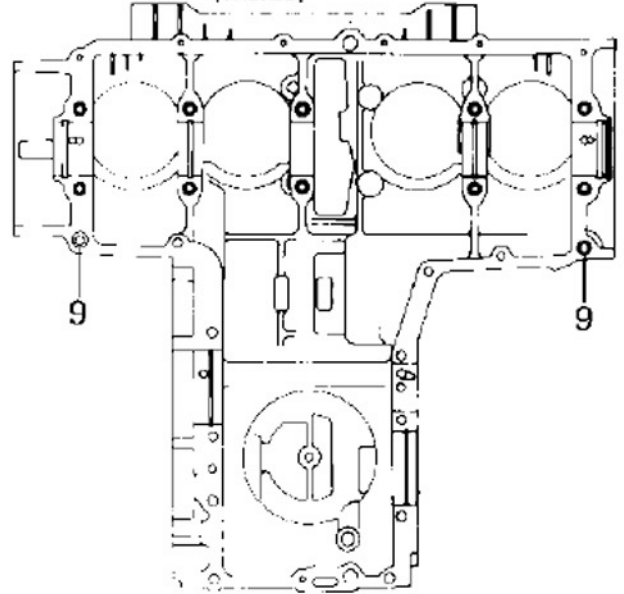

(L.H.)

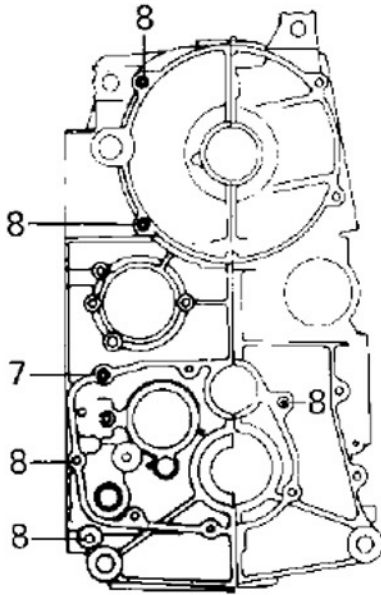



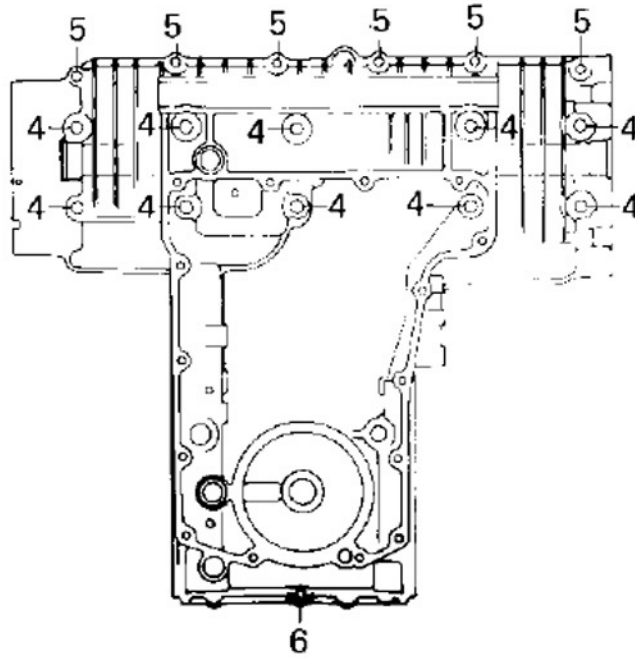

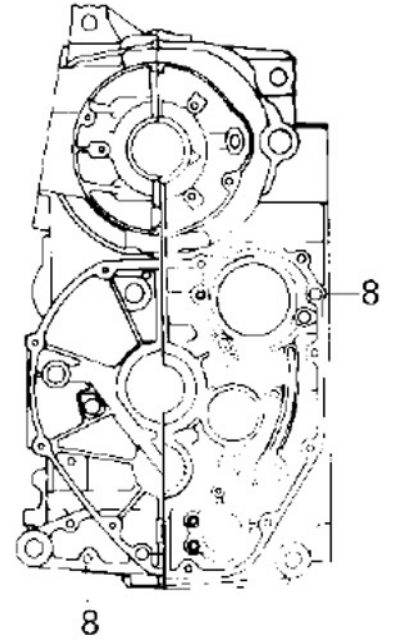

Lower Case
(Outside)



(R.H.)

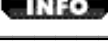
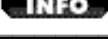
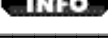
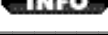

Ref #	Part #	Description	Qty	Spec Code
1	92003-111 	BOLT,HEX HEAD,6X99	5	
2	92003-113 	BOLT,HEX HEAD,6X116	1	
3	*92003-179 	UNAVAILABLE IN PRICE BOOK	2	MARKED PARTS ARE INCLUDED IN C
3	130G0650 	BOLT-FLANGED,6X50	1	
4	130P0895 	BOLT-FLANGED,8X95	10	
5	*92003-109 	UNAVAILABLE IN PRICE BOOK	1	MARKED PARTS ARE INCLUDED IN C
5	92003-109 	BOLT,HEX HEAD,6X41	9	
6	92003-194 	BOLT,6X105	1	
7	551A0614 	PIN,DOWEL,6X14	1	
8	92042-007 	PIN-DOWEL	7	
9	*92043-1037 	UNAVAILABLE IN PRICE BOOK	2	MARKED PARTS ARE INCLUDED IN C



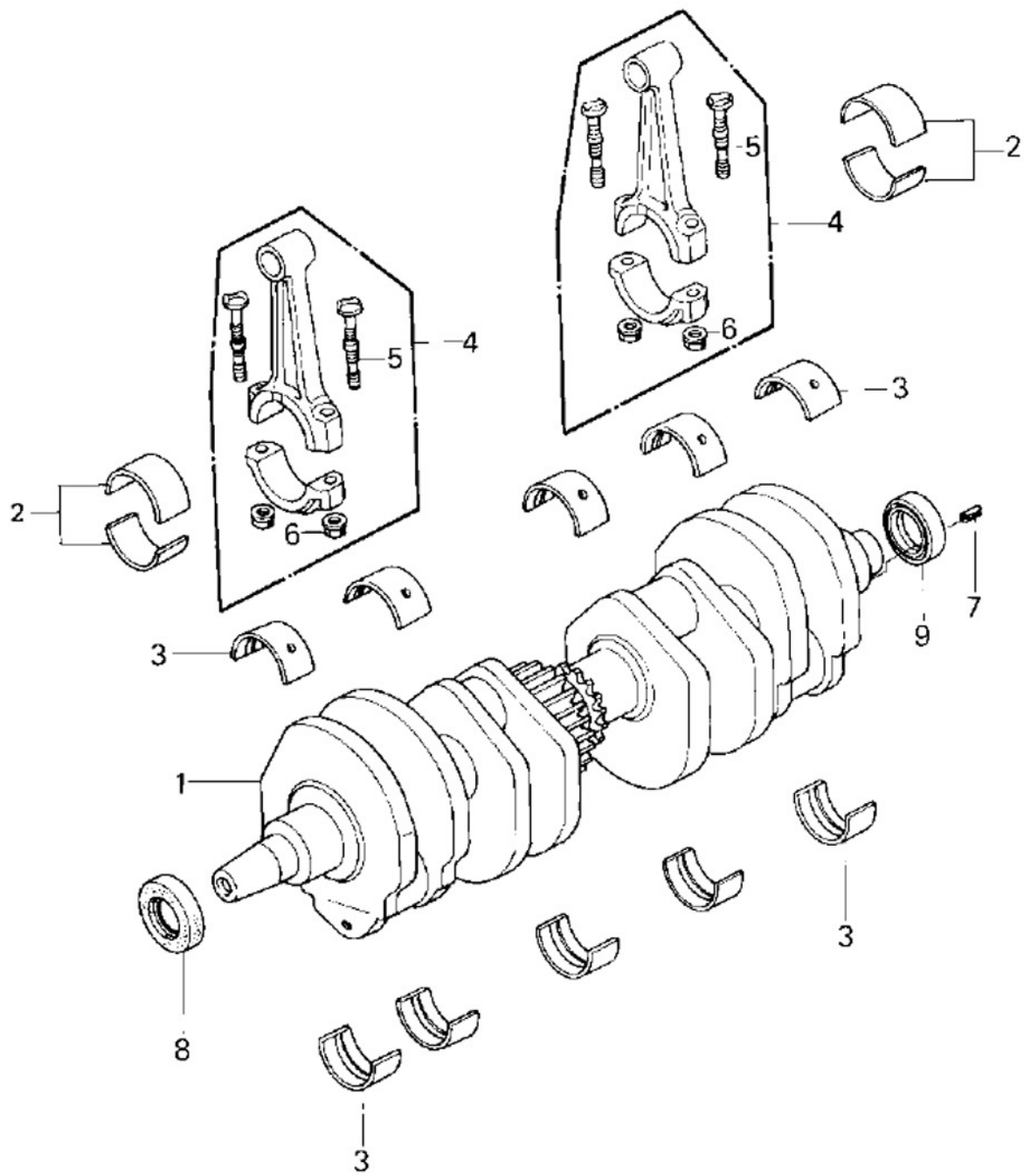





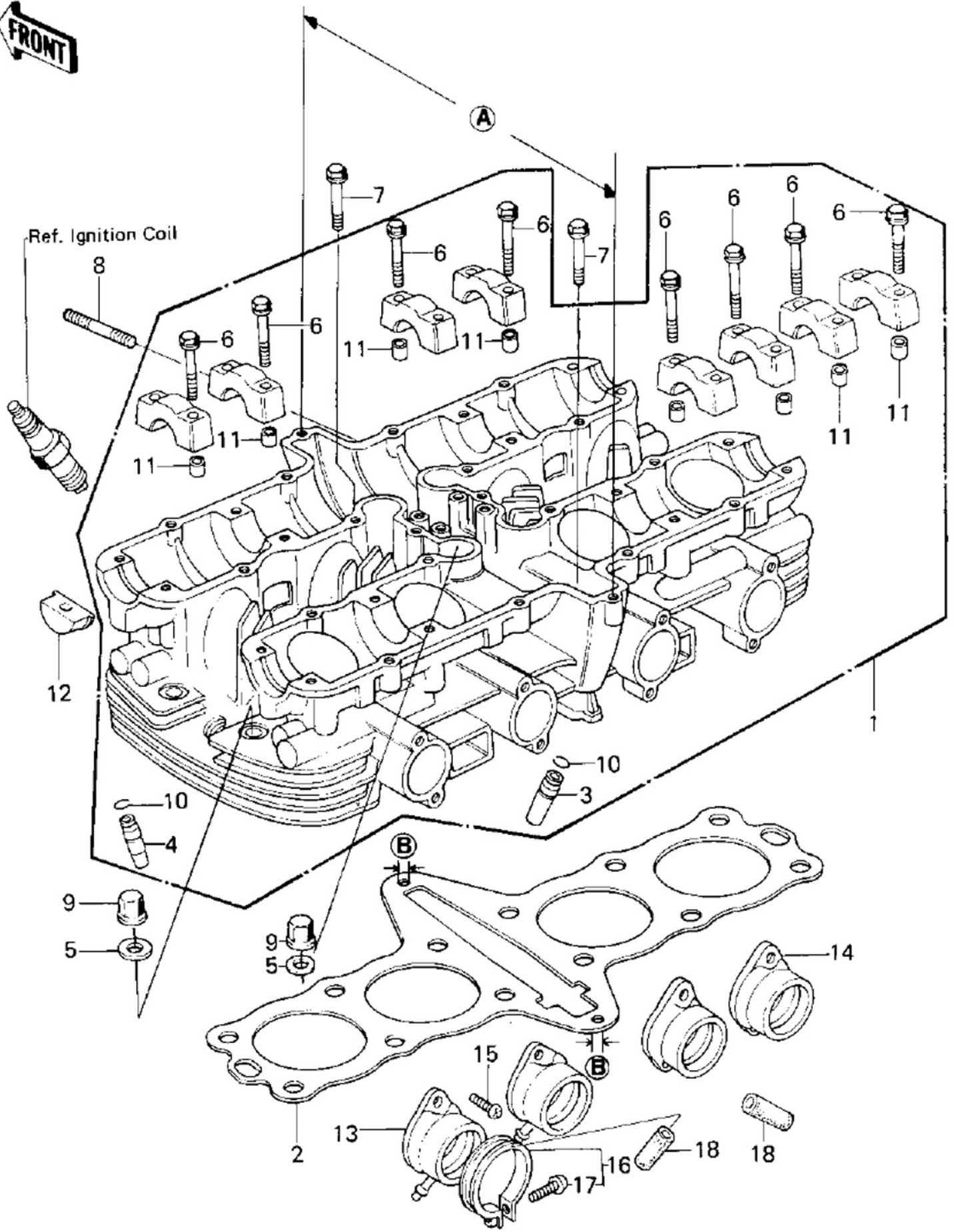





FRONT



Ref #	Part #		Description	Qty	Spec Code
1	13037-069	INFO	CRANKSHAFT ASSY	1	
2	13034-050	INFO	METAL,CONNECT ROD BRG	8	GREEN OR "A" MARK
2	13034-051	INFO	METAL,CONNECT ROD BRG	8	BLACK OR "B" MARK
2	13034-052	INFO	METAL,CONNECT ROD BRG	8	BROWN OR "C" MARK
3	92028-1100	INFO	BUSHING,CRANKSHAFT	10	BLUE
3	92028-1101	INFO	BUSHING,CRANKSHAFT	10	BLACK
3	92028-1101	INFO	BUSHING,CRANKSHAFT	10	
3	92028-1102	INFO	BUSHING,CRANKSHAFT	10	BROWN
4	13251-1003-HH	INFO	CONNECTING ROD ASSY	4	E/NO. 114501~114513
4	13251-1007-JJ	INFO	CONNECTING ROD ASSY,J	4	E/NO. 114501~114513
4	13251-1007-JJ	INFO	CONNECTING ROD ASSY,J	4	E/NO. 114514~123772
4	13251-1007-KK	INFO	CONNECTING ROD ASSY,K	4	E/NO. 114514~123772
5	92001-1793	INFO	BOLT,CONNECTING ROD	8	USE W/13251-1003
5	92001-1887	INFO	BOLT,CONNECTING ROD,8	8	USE W/13251-1007
6	92016-060	INFO	NUT,CONNECTING ROD	8	USE W/92001-1053
6	92015-1311	INFO	NUT,FLANGED,8MM	8	USE W/92001-1288
7	555A0408	INFO	PIN-SPRING,4X8	1	
8	92050-080	INFO	OIL SEAL,HSCY22397	1	
9	92050-081	INFO	OIL SEAL,HSCY25397	1	

FRONT







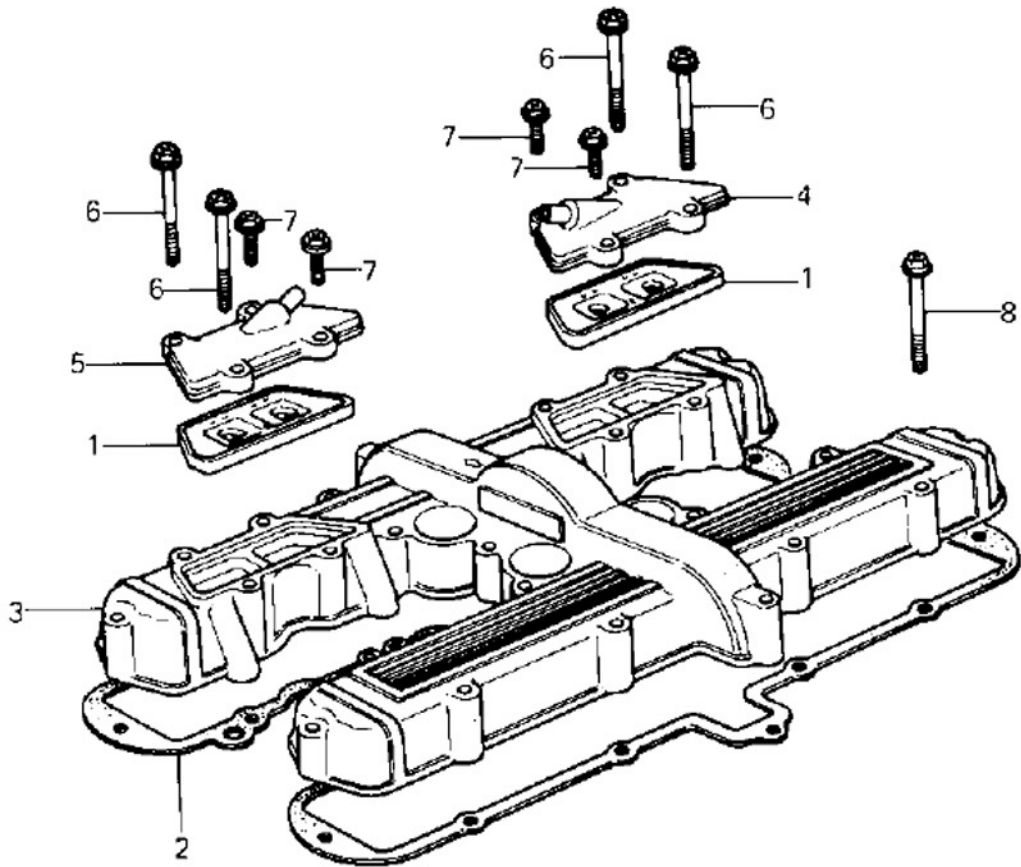
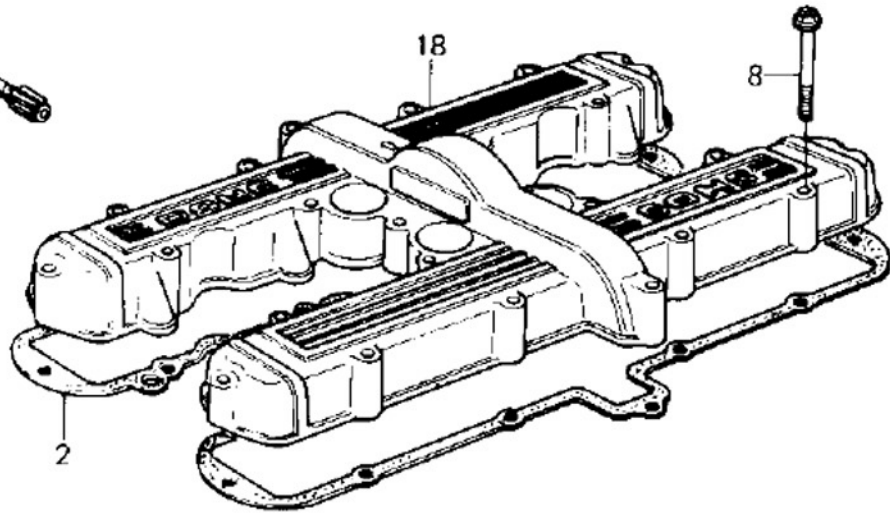
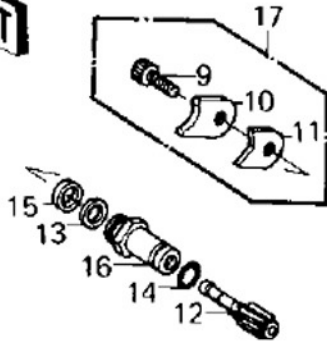



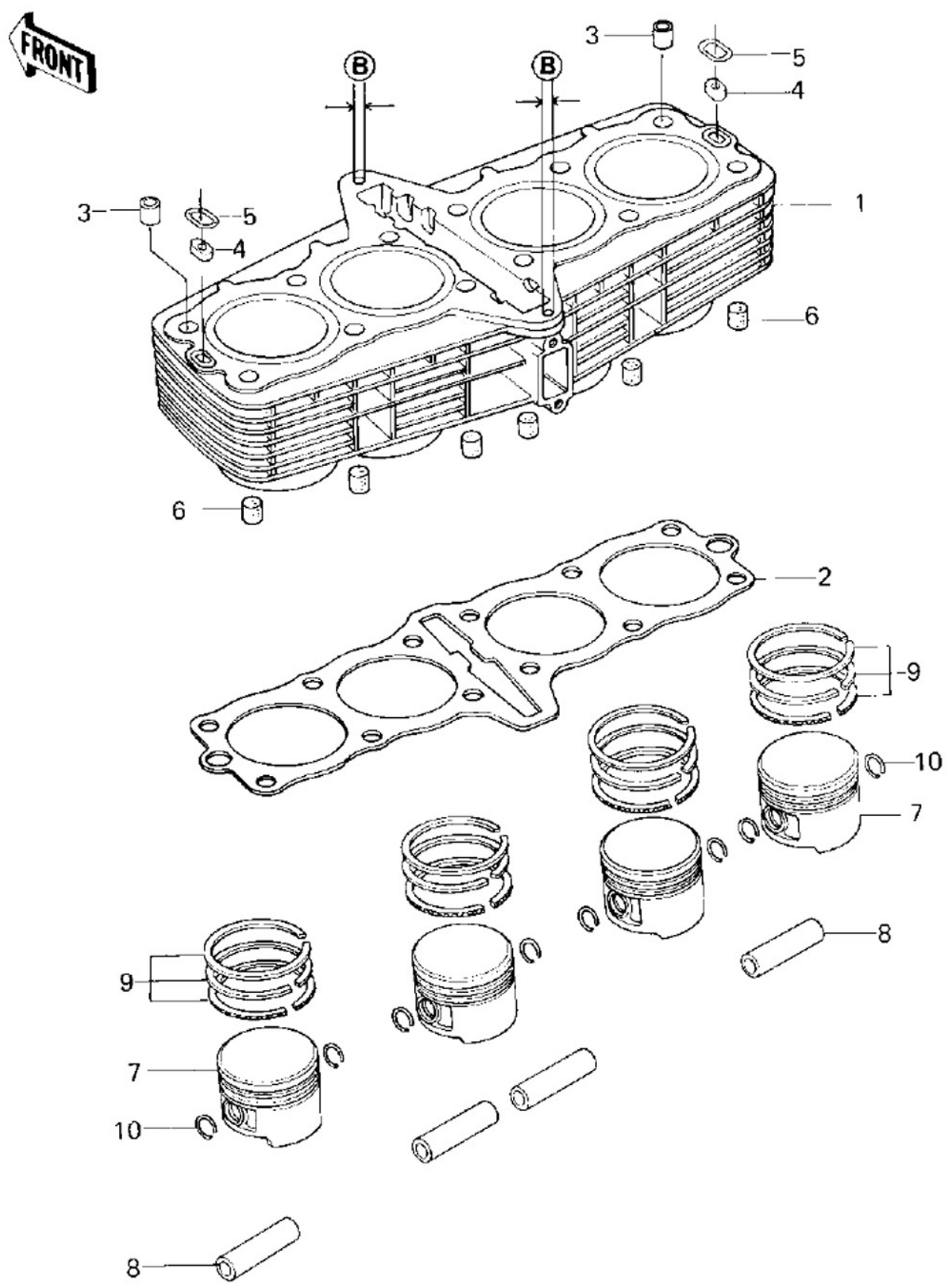







Ref #	Part #	Description	Qty	Spec Code
1	11002-1014 	HEAD ASSY,CYLINDER	1	E/NO. 114501~118270
1	11002-1075 	HEAD-ASSY-CYLINDER,BA	1	E/NO. 118271~123772
1	11002-1038 	11002-1076 (Canada)	1	
2	11004-1107 	GASKET-HEAD,CYLINDER	1	E/NO. 114501~118270
2	11004-1107 	GASKET-HEAD,CYLINDER	1	E/NO. 118271~123772
3	12013-009 	GUIDE,INLET VALVE	4	
4	49002-1002 	GUIDE,EXHAUST VALVE	4	
5	411B1000 	WASHER PLAIN 10MM	12	
6	92001-1105 	BOLT,FLANGED,6X38	16	
7	92002-1881 	BOLT,6X43	2	E/NO. 114501~118270
7	92001-1445 	BOLT,FLANGED,8X43	2	E/NO. 118271~123772
7	92001-1445 	BOLT,FLANGED,8X43	2	
8	92004-066 	STUD,6X27	8	
9	92015-076 	NUT,CYLINDER HEAD	12	
10	92036-023 	CIRCLIP-VALVE	8	
11	92042-007 	PIN-DOWEL	16	
12	92066-1111 	PLUG,CAMSHAFT,11.35X1	4	
13	16065-046 	HOLDER,CARB,L.H.	2	
14	16065-047 	HOLDER,CARB,R.H	2	
15	220B0618 	SCREW PAN HEAD 6X18	8	
16	92037-178 	CLAMP,CARBURETOR HLDR	4	
17	220B0525 	SCREW-PAN-CROS,5X25	4	
18	92068-006 	RUBBER PLUG	2	

FRONT









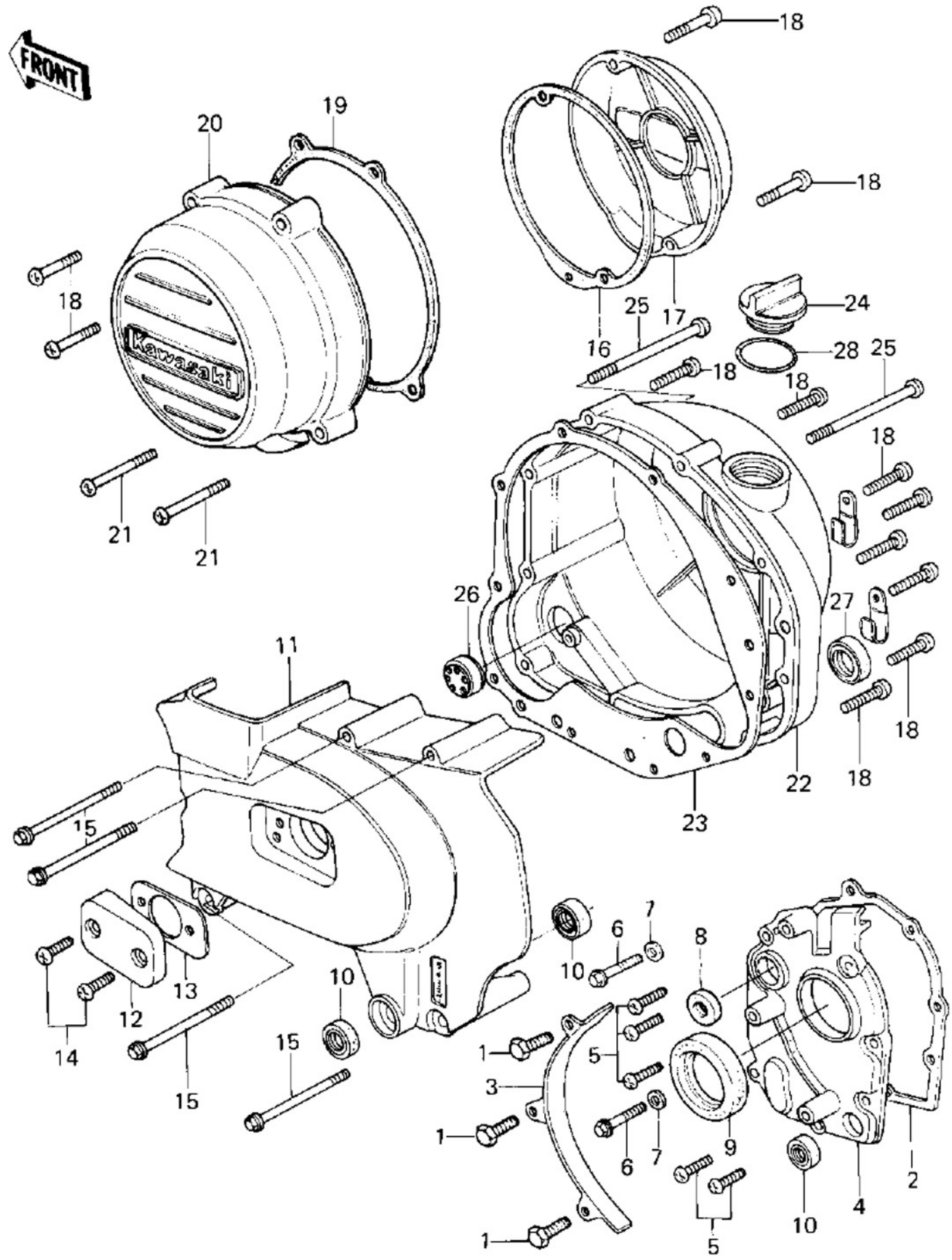









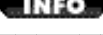
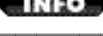
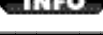
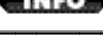
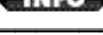
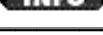
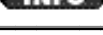

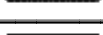
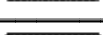
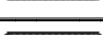

Ref #	Part #	Description	Qty	Spec Code
1	12021-1003 	VALVE ASSY REED	2	
2	11009-1065 	GASKET,CYL HEAD COVER	1	E/NO. 114501~118270
2	11009-1237 	GASKET,CYLINDER HEAD	1	E/NO. 118271~
3	14025-1058 	COVER,CYLINDER HEAD	1	E/NO. 114501~118270
3	14025-1209 	COVER,CYLINDER HEAD	1	E/NO. 118271~
4	14075-5001 	CAP ASSY,R.H,REED VLV	1	
5	14075-5002 	CAP ASSY,L.H,REED VLV	1	
6	92001-1102 	BOLT,HEX HEAD,6X65	4	
7	92001-1352 	BOLT,FLANGED,6X22	4	
8	92001-165 	BOLT,HEX HEAD,6X45	20	
8	92001-165 	BOLT,HEX HEAD,6X45	24	
9	120P0614 	BOLT,6X14	1	
10	13091-1008 	HOLDER,TACHOMETER2.3T	1	
11	13091-1009 	HOLDER,TACHOMETR,3.2T	1	
12	13223-011 	GEAR,TACHOMETER,10T	1	
13	92050-075 	OIL SEAL	1	
14	92055-1149 	RING-O,10MM	1	
15	92065-103 	GASKET,TACHOMETER GER	1	
16	92087-010 	GUIDE,TACHOMETER GEAR	1	
17	13091-5001 	HOLDER SET,TACHOMETER	1	
18	14025-1203 	COVER,CYLINDER HEAD	1	







Ref #	Part #	Description	Qty	Spec Code
1	11005-1039 	CYLINDER	1	E/NO. 014501~118270
1	11005-1077 	CYLINDER	1	E/NO. 118271~123772
2	11060-1362 	GASKET	1	
3	92043-1266 	PIN,11X14X12.3	2	
4	92043-1210 	PIN,OIL LINE	2	
5	92055-1147 	RING-O	2	
6	92066-1016 	PLUG,DAMPER	6	
7	13001-1002 	PISTON,STD	4	
7	13029-077 	PISTON,0.020",O.S.	4	
7	13027-069 	PISTON,0.040",O.S.	4	
8	13002-032 	PIN-PISTON	4	
9	13008-059 	RING SET,PISTON,STD	4	
9	13025-061 	RING SET,0.020",O.S.	4	
9	13024-060 	RING SET,0.040",O.S.	4	
10	92036-005 	CIRCLIP PISTON PIN	8	

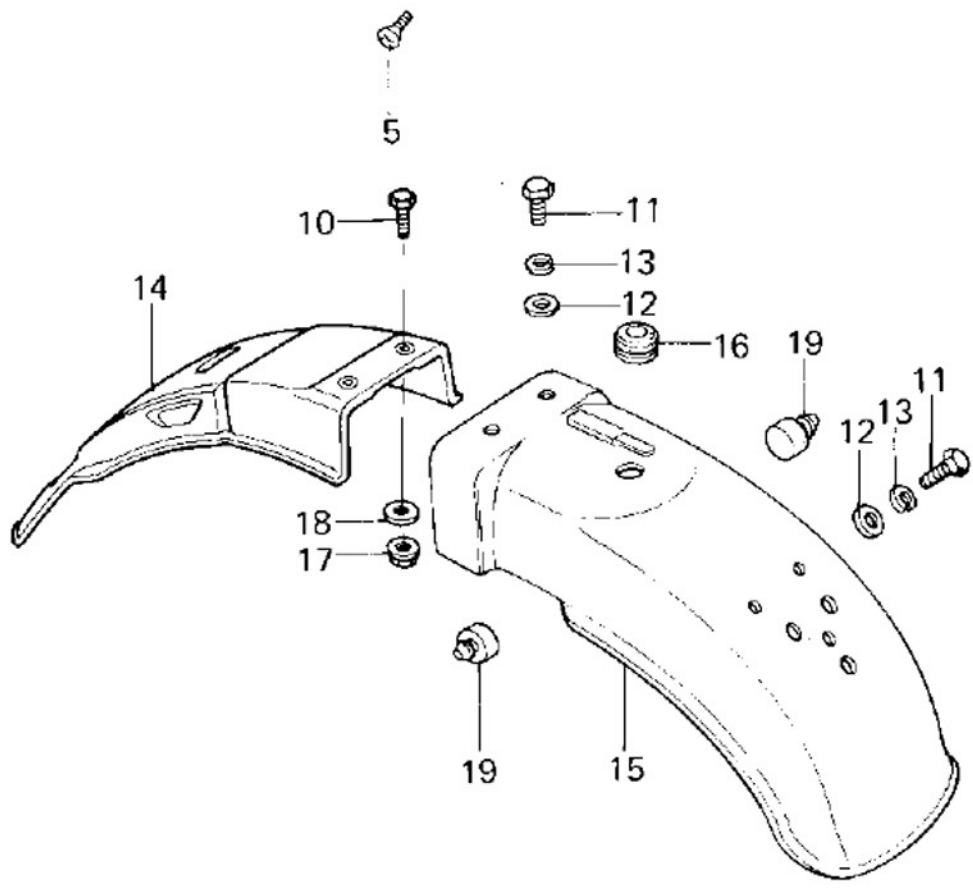
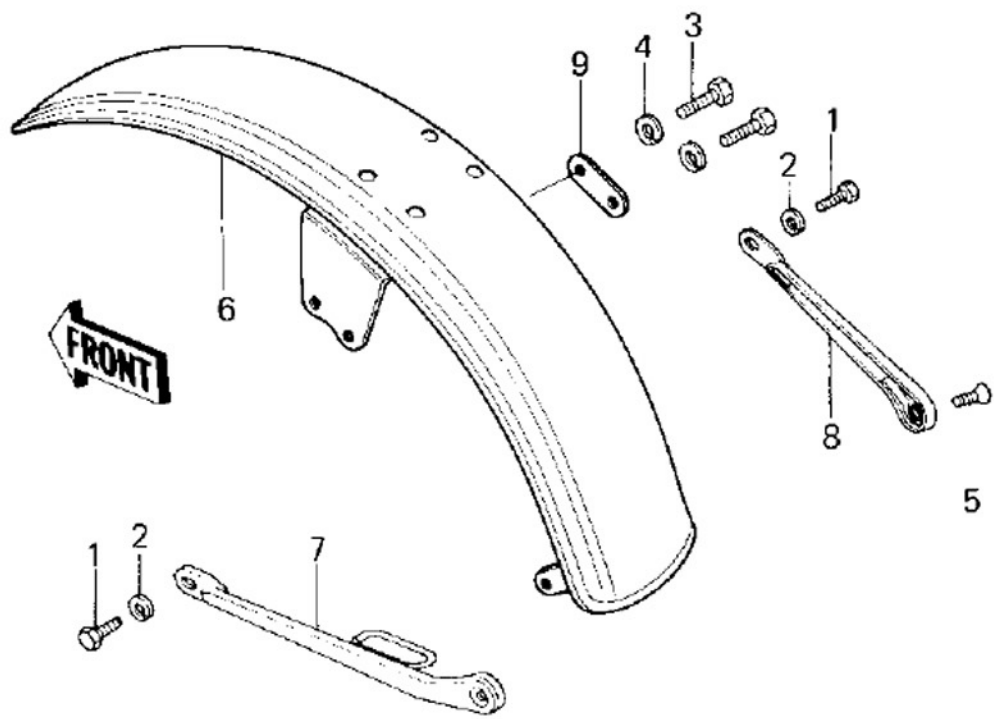

Ref #	Part #	Description	Qty	Spec Code
1	112B0614 	BOLT-UPSET 6X14	3	
2	11060-1056 	GASKET,TRANSMISSION C	1	
3	12053-1006 	GUIDE,CHAIN	1	
4	14024-011 	COVER,MISSION	1	
5	220B0620 	SCREW PAN HEAD 6X20	5	
6	92001-164 	BOLT,HEX HEAD,6X35	2	
7	92022-077 	WASHER OIL PUMP BANJO	2	
8	92050-048 	OIL SEAL,TC7187	1	E/NO. 114501~118403
8	92049-1017 	OIL SEAL,SD-8187	1	E/NO. 118404~123772
9	92050-024 	OIL SEAL SC325210	1	
10	92051-005 	OIL SEAL,TB13225.5	3	
11	14026-035-80 	COVER,ENG SPROCKT,BUF	1	
12	14028-006-80 	COVER,CLUTCH ADJUSTNG	1	
13	14049-004 	GASKET,CLUTCH ADJ CAP	1	
14	220B0618 	SCREW PAN HEAD 6X18	2	
15	130G0670 	BOLT-FLANGED,6X70	4	
16	11060-1053 	GASKET,PULSING COIL C	1	
17	11012-1098 	CAP,CONTACT BREAKER	1	
18	220B0630 	SCREW PAN HEAD 6X30	12	
19	11009-1987 	GASKET,GENERATOR COVE	1	
20	14031-1040 	COVER,GENERATOR	1	
21	220B0640 	SCREW PAN HEAD 6X40	2	
22	14032-117-80 	COVER,R.H.ENG,BUFF FN	1	
23	14046-035 	GASKET,R.H.ENG COVER	1	
24	16115-013 	PLUG,OIL FILLER	1	
25	220B0680 	SCREW PAN HEAD 6X80	2	
26	52015-004 	GAUGE,OIL LEVEL	1	
27	92049-012 	OIL SEAL SB20285	1	
28	92055-049 	"0" RING,31MM	1	

FRONT







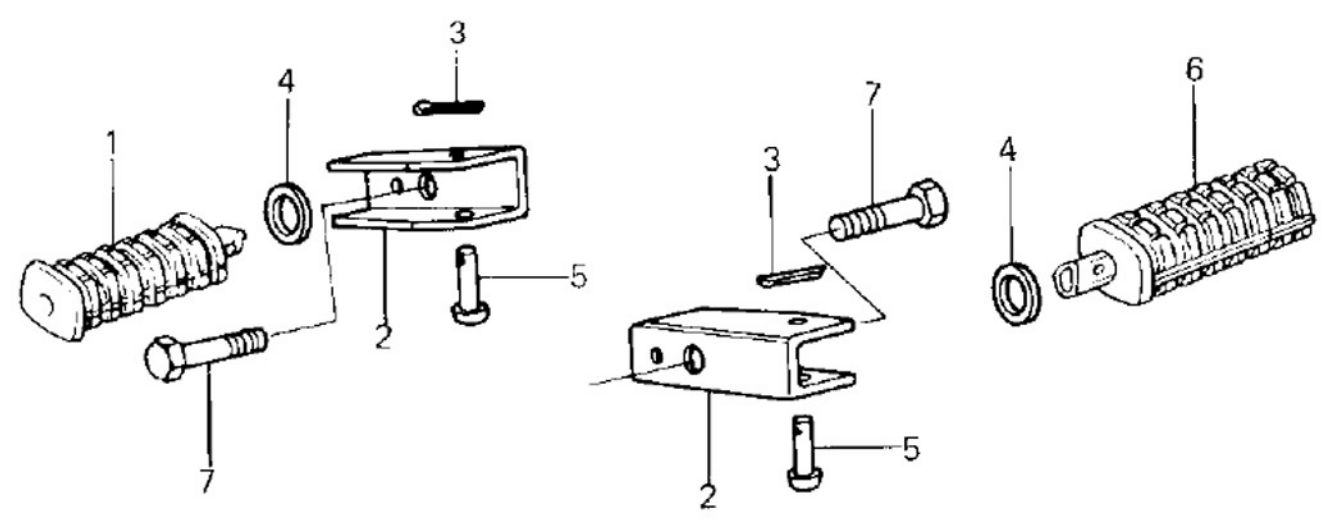
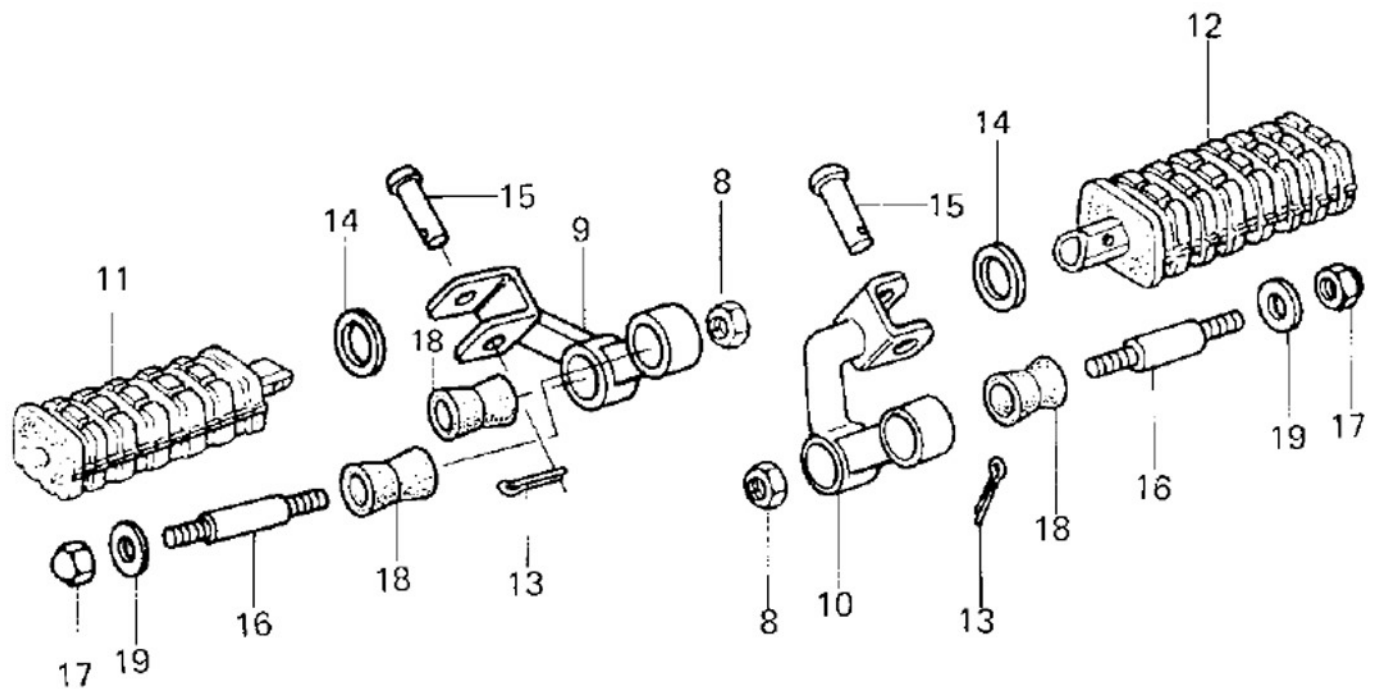



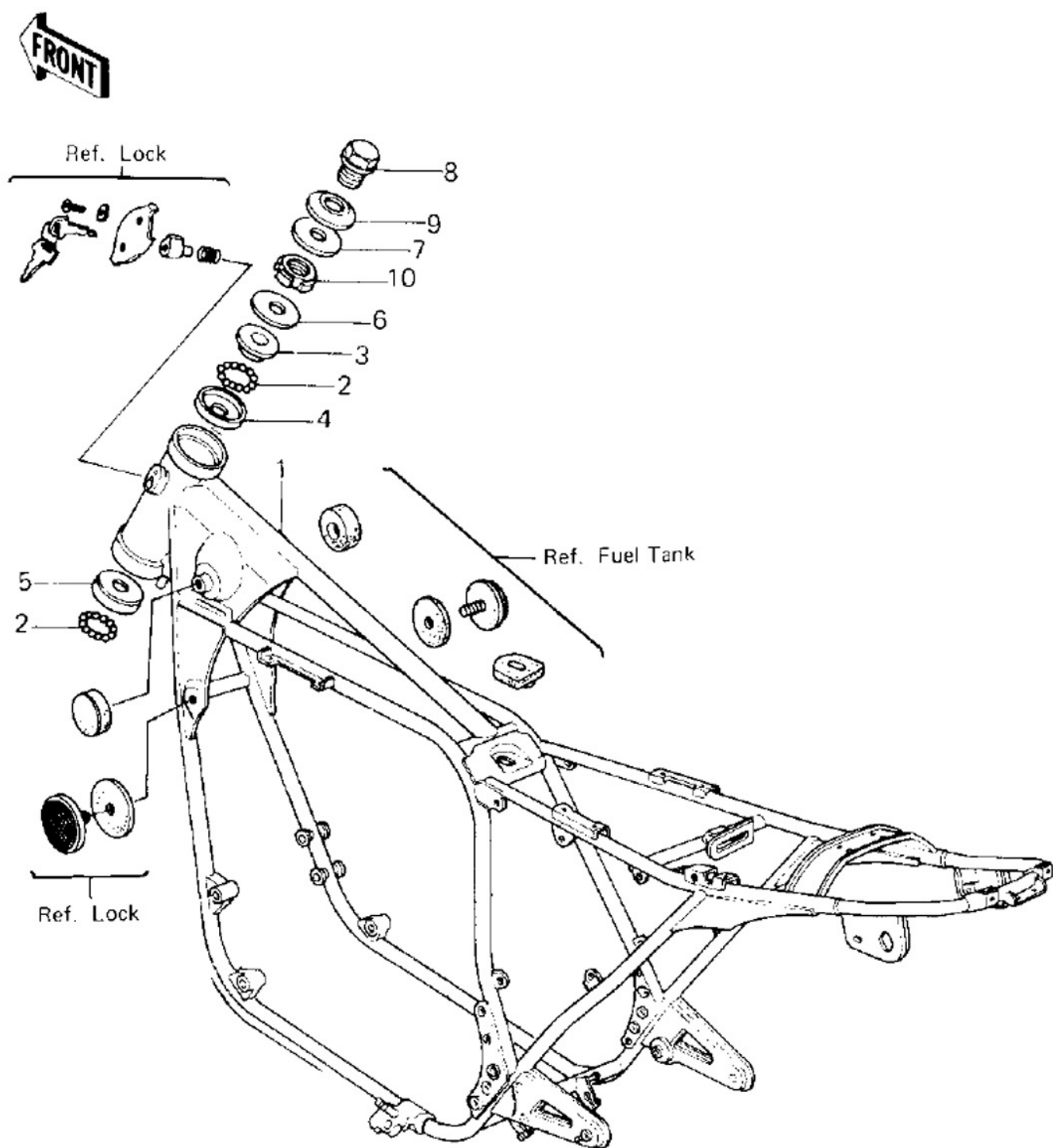

Ref #	Part #	Description	Qty	Spec Code
1	112G0612 	BOLT-UPSET,6X12	2	
2	461F0600 	WASHER SPRING 6MM	2	
3	115G0816 	BOLT-SMALL-UPSET,8X16	4	
4	461F0800 	WASHER SPRING 8MM	4	
5	222E0616 	SCREW,OVL CNTSNK,6X16	2	
6	35001-1017 	FENDER-FR	1	
7	35011-1001 	STAY,FRONT FENDER,L.H	1	
8	35011-1002 	STAY,FRONT FENDER,R.H	1	
9	92026-1008 	SPACER,FRONT FENDER	1	
10	112G0616 	BOLT-UPSET,6X16	2	
11	112B0614 	BOLT-UPSET 6X14	4	
12	410B0600 	WASHER PLAIN 6MM	4	
13	461F0600 	WASHER SPRING 6MM	4	
14	35022-1046 	FENDER-RR	1	
15	35022-153 	FENDER-RR	1	
16	92071-019 	GROMMET HARNESS 10MM	1	
17	92015-1078 	NUT-6MM	2	
18	92022-125 	WASHER 6.5X20X1.6T	2	
19	92075-135 	DAMPER RUBBER,RR FEND	2	

FRONT









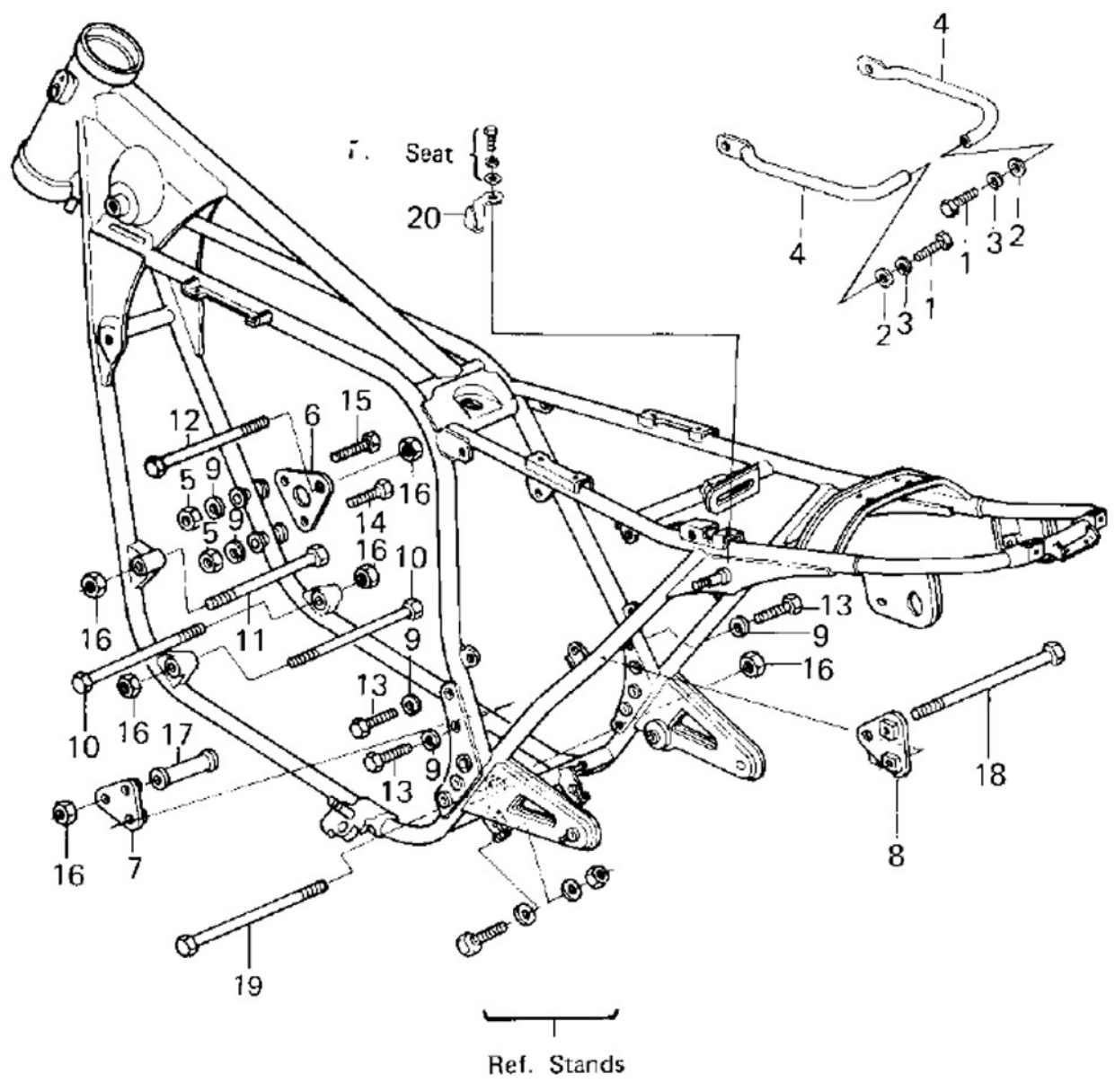

Ref #	Part #	Description	Qty	Spec Code
1	34028-1009 	STEP,FOOTREST,REAR,LH	1	
2	34036-002 	BRACKET,REAR FOOTREST	2	
3	550D2012 	PIN,COTTER,2.0X12	2	
4	92022-181 	WASHER-PLAIN	2	
5	92043-1464 	PIN	2	
6	34028-1010 	STEP,FOOTREST,REAR,RH	1	
7	92003-213 	BOLT,HEX HEAD,10X40	2	
8	315B1000 	NUT 10MM	4	
9	34003-1012 	HOLDER,STEP,L.H.	1	
10	34003-1015 	HOLDER,STEP,R.H.	1	
11	34028-1007 	STEP,FOOTREST,FRONT,L	1	
12	34028-1008 	STEP,FOOTREST,FRONT,R	1	
13	550D2516 	PIN COTTER 2.5X16	2	
14	92022-250 	WASHER,PLAIN	2	
15	92043-080 	PIN-FOOTREST BAR FIT	2	
16	92004-048 	STUD,FOOTREST BAR FIT	4	
17	92019-013 	NUT,CAP AND LOCK,8MM	4	
18	92075-293 	DAMPER RUBBER,FOOTRES	4	
19	92102-010 	CAP,FOOTRESTBAR	4	









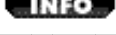
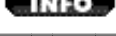
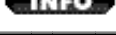
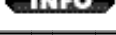
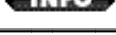
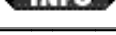
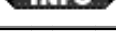
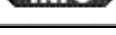
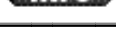
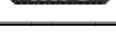
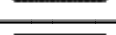
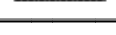

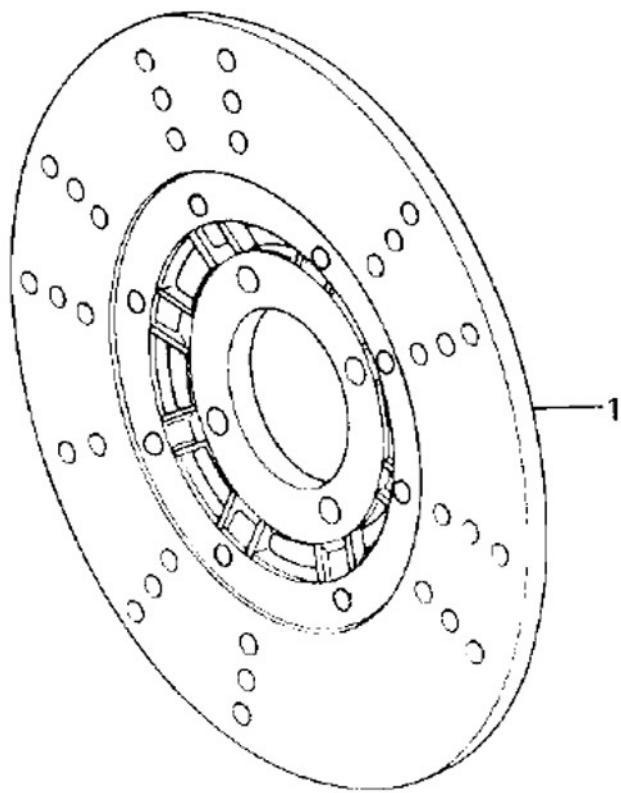
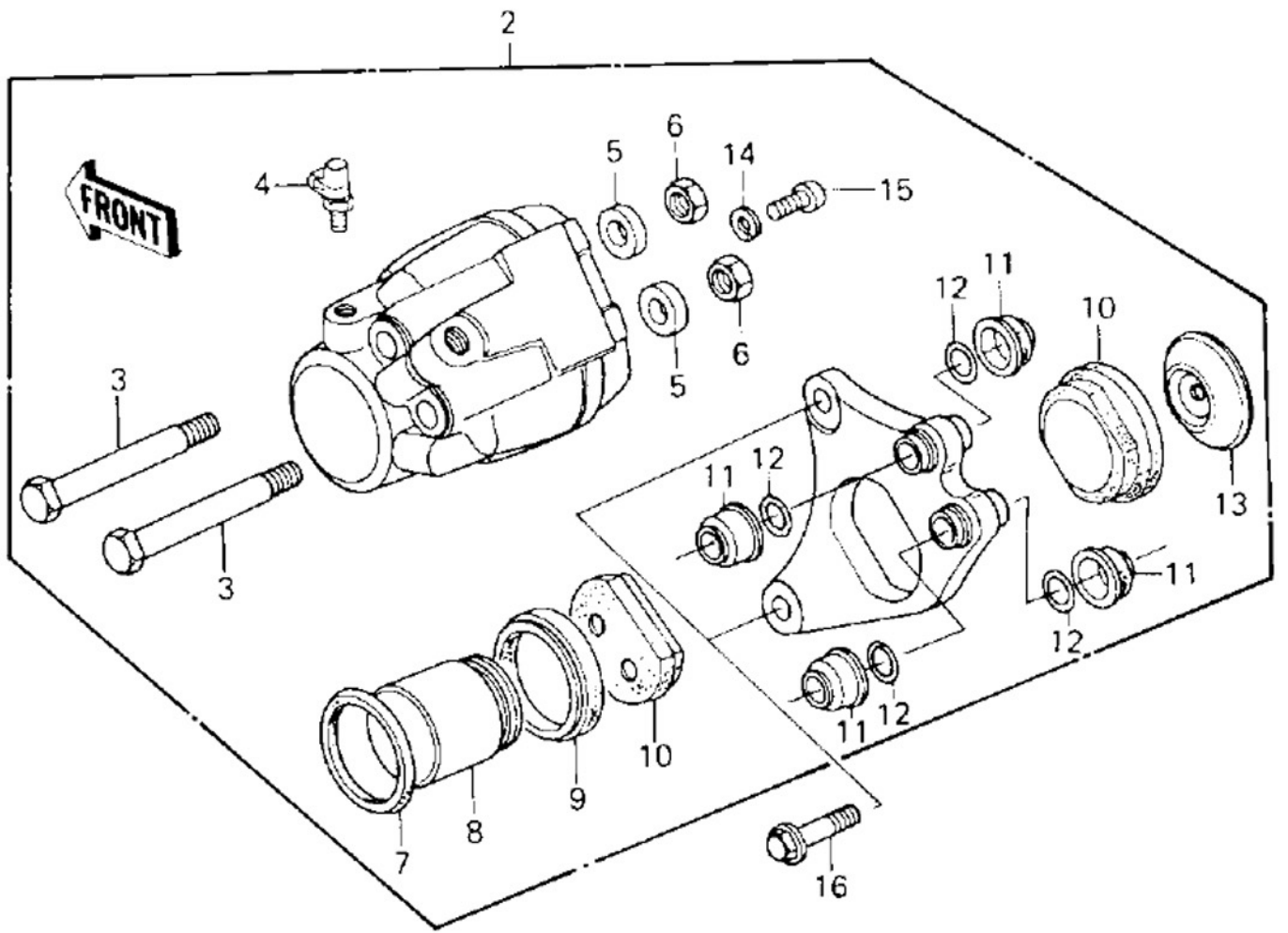







Ref #	Part #	Description	Qty	Spec Code
1	32002-1049 	FRAME	1	
2	600A0800 	BALL STEEL 1/4'	39	
3	92047-011 	CONE,STRNG STM BRNG	1	
4	92048-006 	RACE STRNG STEM BERNG	1	
5	92048-008 	RACE,STRNG STM BRNG	1	
6	46098-016 	CAP, STEERING STEM	1	
7	46100-003 	WASHER,WAVE	1	
8	92007-031 	BOLT,STEERG STEM HEAD	1	
9	92022-230 	WASHER,STEERG STM HD	1	
10	92090-007 	NUT STEERING STEM LCK	1	

FRONT





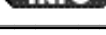

Ref #	Part #	Description	Qty	Spec Code
1	115G0816 	BOLT-SMALL-UPSET,8X16	2	
2	410B0800 	WASHER PLAIN 8MM	2	
3	461F0800 	WASHER SPRING 8MM	2	
4	32109-016 	GRIP,FRAME	2	
5	311B0800 	NUT,8MM	2	
6	32030-063 	PLATE,FRONT ENG.MOUNT	1	
7	32030-064 	PLATE,RR ENG MONT,L.H	1	
8	32030-065 	PLATE,RR ENG MONT,R.H	1	
9	461F0800 	WASHER SPRING 8MM	6	
10	92001-1048 	BOLT,HEX HEAD,10X84	2	
11	92001-1049 	BOLT,HEX HEAD,10X72	1	
12	92001-1050 	BOLT,HEX HEAD,10X46	1	
13	92001-1230 	BOLT,HEX HEAD,8X40	4	
14	92001-1581 	BOLT,FLANGED,8X60	1	
15	92001-1397 	BOLT-8X63	1	
16	92019-021 	NUT,LOCK,10MM	6	
17	92027-275 	COLLAR,L=54MM.	1	
18	92091-023 	BOLT,ENGINE MOUNTING	1	
19	92091-032 	BOLT,HEX HEAD,10X219	1	
20	32122-057 	BRACKET,HELMET HOLDER	1	

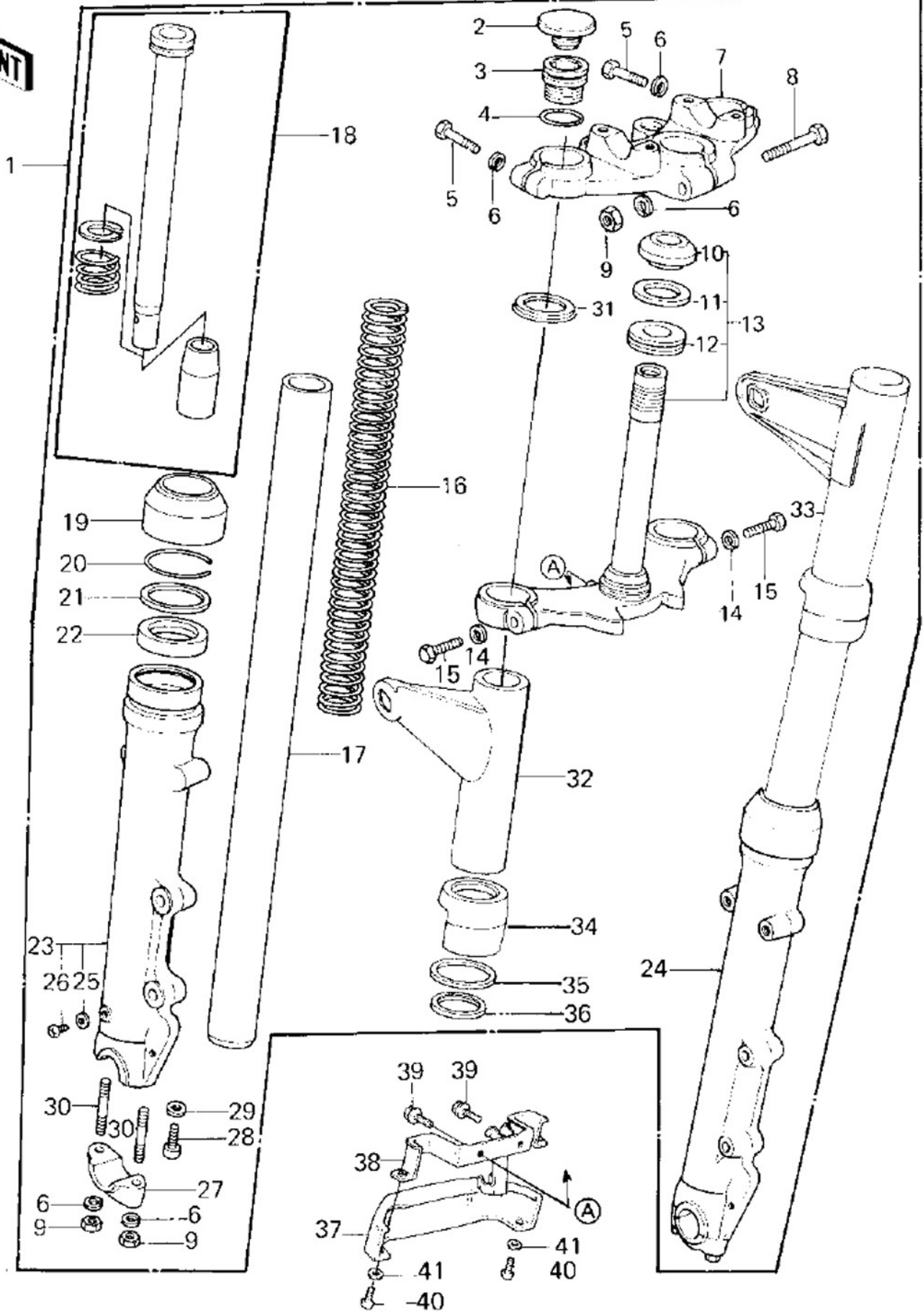

Ref #	Part #	Description	Qty	Spec Code
1	41080-1022 	DISC PLATE,FRONT BRAK	1	
2	43041-1024 	CALIPER ASSY,L.H,	1	
3	43045-006 	BOLT	2	
4	43085-001 	BLEEDER SET	1	
5	43088-002 	PLUG	2	
6	315B1000 	NUT 10MM	2	
7	43049-002 	RING,PISTON SEAL	1	
8	43020-1012 	PISTON,BRAKE,42M/M	1	
9	43054-003 	DUST SEALD,RUBBER	1	
10	43082-1001 	PAD SET	1	
11	43052-005 	DUST SHILD,SHAFT	4	
12	43053-006 	"O" RING	4	
13	43040-004 	SPACER	1	
14	461F0600 	WASHER SPRING 6MM	1	
15	220B0612 	SCREW PAN HEAD 6X12	1	
16	92001-1293 	BOLT,HEX HEAD,10X38	2	









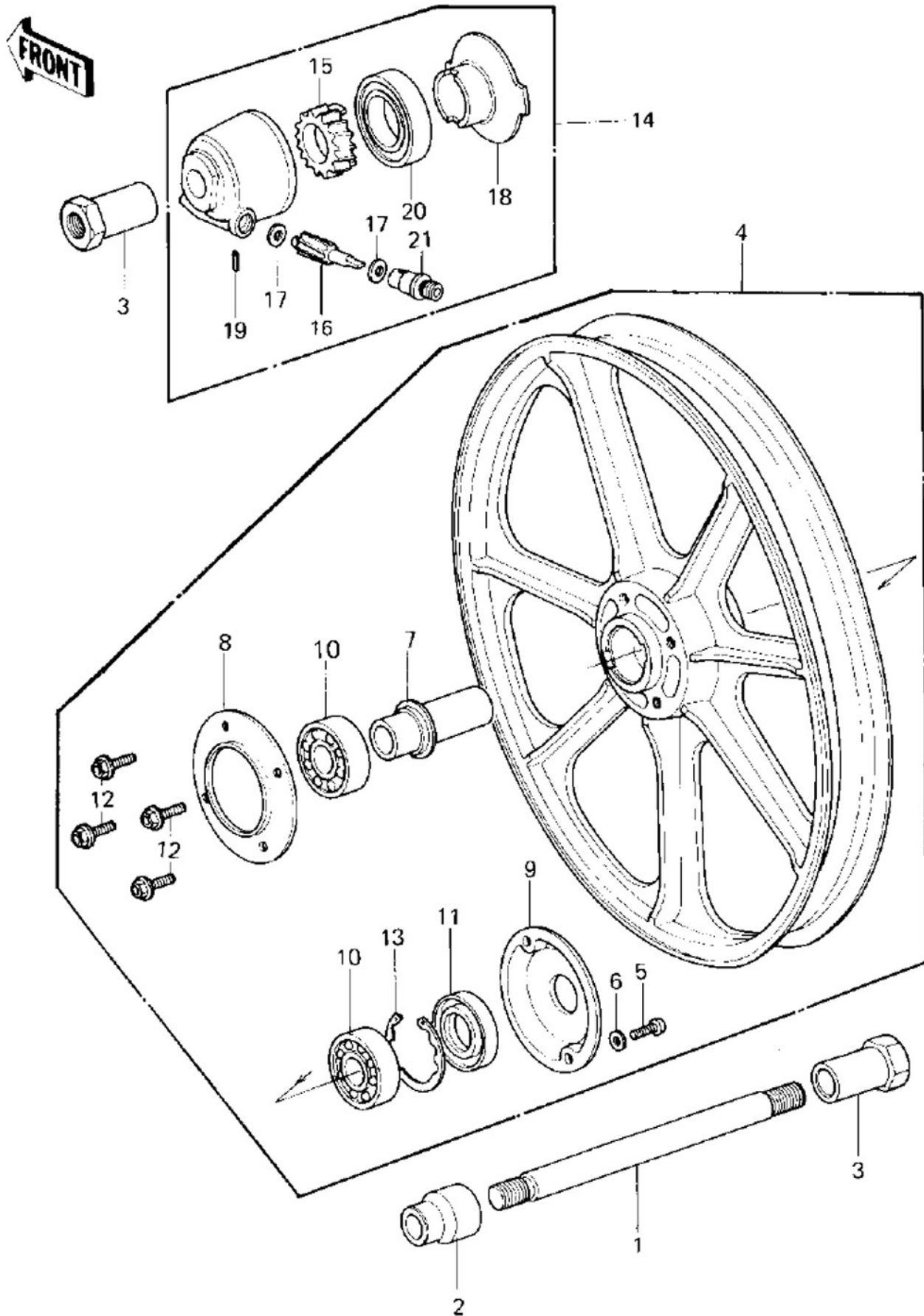











FRONT



Ref #	Part #	Description	Qty	Spec Code
1	44001-1092 	FORK-FRONT	1	
2	11012-1017 	CAP,RUBBER	2	
3	44029-1003 	CAP,FORK SPRING	2	
4	92055-1009 	"O" RING,FORK TOP	2	
5	44041-045 	BOLT-HEX HEAD.8M/M	2	
6	461F0800 	WASHER SPRING 8MM	7	
7	44039-076 	HEAD,STEERING STEM	1	
8	44041-042 	BOLT-STEERING STEM HD	1	
9	92015-1124 	NUT,LOCK,8MM	5	
10	92047-012 	CONE,STEERING STEM	1	
11	92022-231 	WASHER,PLAIN	1	
12	92056-003 	OIL SEAL,STEERING STM	1	
13	44037-107 	STEM,STEERING	1	
14	461F1200 	WASHER SPRING 12MM	2	
15	92003-064 	BOLT-HEX HEAD,12X36	2	
16	44026-1040 	SPRING,FORK	2	
17	44013-1027 	TUBE,FORK INNER	2	
18	44022-1011 	CYLINDER-FORK	2	
19	44010-032 	DUST SHEILD,FORK	2	
20	44044-012 	CIRCLIP-OIL SEAL FIT	2	
21	44043-044 	WASHER-OIL SEAL FIT	2	
22	92049-1216 	SEAL-OIL,FORK OUTER P	2	
23	44005-1031 	TUBE,LH,FORK OUTER	1	
24	44006-1031 	TUBE,RH,FORK OUTER	1	
25	44045-002 	GASKET FORK DRAIN PLG	2	
26	220B0408 	SCREW PAN HEAD 4X8	2	
27	44063-014 	HOLDER,FRONT AXLE	2	
28	44041-040 	BOLT-FORK CYLINDER	2	
29	44045-057 	GASKET,FORK CYLINDER	2	

30	92004-1009		STUD,8X35	4	
31	44064-005		WASHER,FORK COVER	2	
32	44033-1017		COVER,L.H.-FORK	1	
33	44033-1018		COVER,R.H,FORK	1	
34	44064-025		GUIDE,FORK COVER	2	
35	44064-008		WASHER,FORK COU GUID	2	
36	44045-038		GASKET,FORK COVER	2	
37	44033-1042		COVER,FORK	1	
38	11034-1602		BRACKET,FORK COVER	1	
39	131B0612		BELT,FLANGED,6X12	2	
40	220B0410		SCREW PAN HEAD 4X10	2	
41	410B0400		WASHER PLAIN 4MM	2	







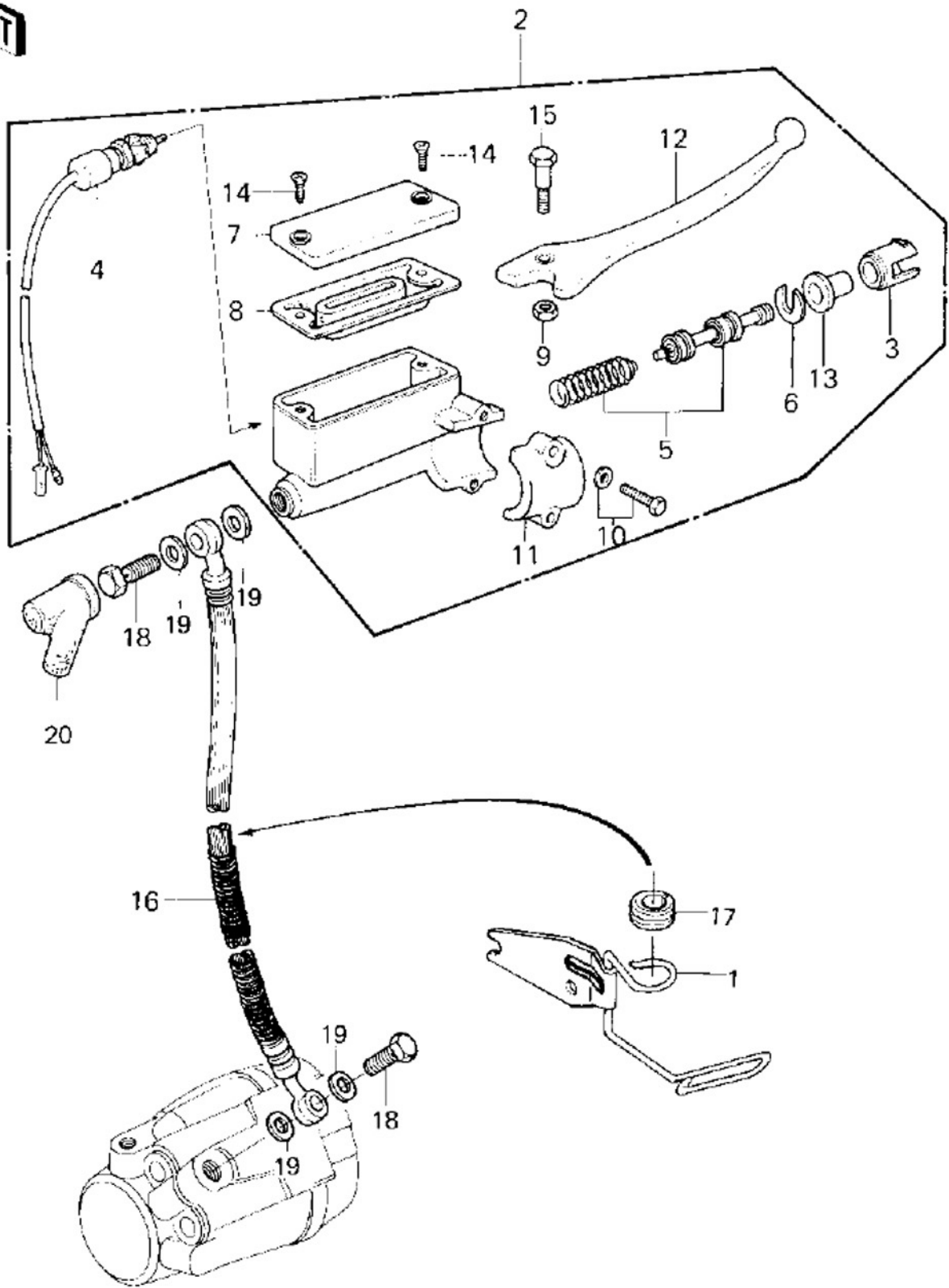



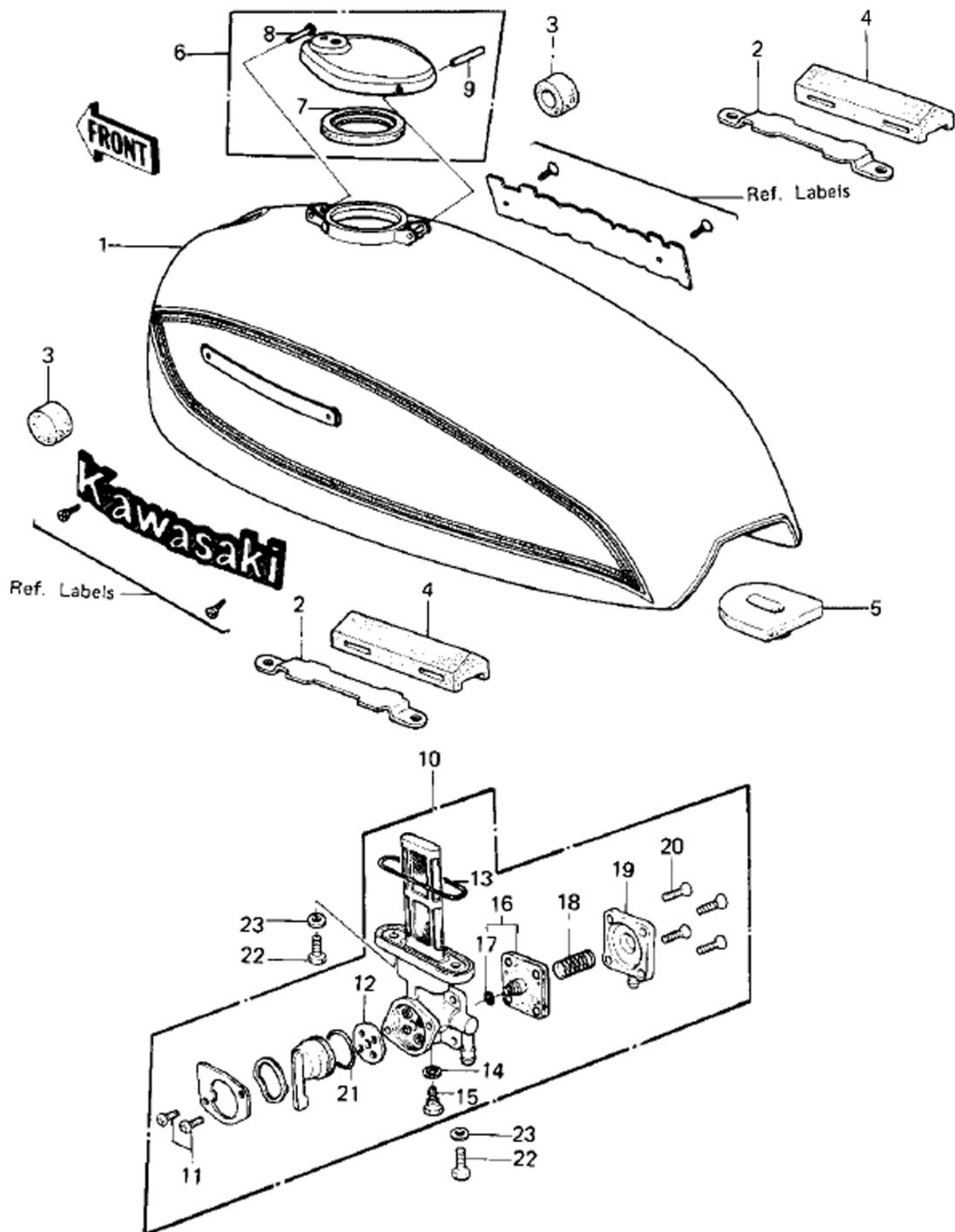















Ref #	Part #	Description	Qty	Spec Code
1	41068-049 	AXLE,FRONT	1	
2	41069-032 	COLLAR,FRONT AXLE	1	
3	41069-033 	COLLAR,FRONT AXLE	2	
4	41073-1058 	SOLID WHEEL ASSY,FR	1	
5	220B0512 	SCREW PAN HEAD 5X12	2	
6	410B0500 	WASHER PLAIN 5MM	2	
7	41039-028 	COLLAR,BRG	1	
8	41042-014 	DUST COVER	1	
9	41042-016 	DUST COVER	1	
10	601B6203Z 	BALL BEARING,#6203ZC3	2	
11	654A254008 	OIL SEAL	1	
12	92001-1173 	BOLT,HEX HEAD,10X30	4	
13	92033-1040 	RING, SNAP,43.5M/M	1	
14	41078-1012 	GEAR BOX ASSY,SPEEDO	1	
15	41059-026 	GEAR,SPEEDOMETER	1	
16	41060-017 	PINION,SPEEDOMETER	1	
17	41063-001 	WASHER THRST SPD PINI	2	
18	41064-013 	RECEIVER,GEAR	1	
19	41082-001 	PIN,SPRING	1	
20	92049-1057 	OIL SEAL,BJN30427-C3	1	
21	92028-1066 	BUSHING,SPEEDOMET CBL	1	

FRONT











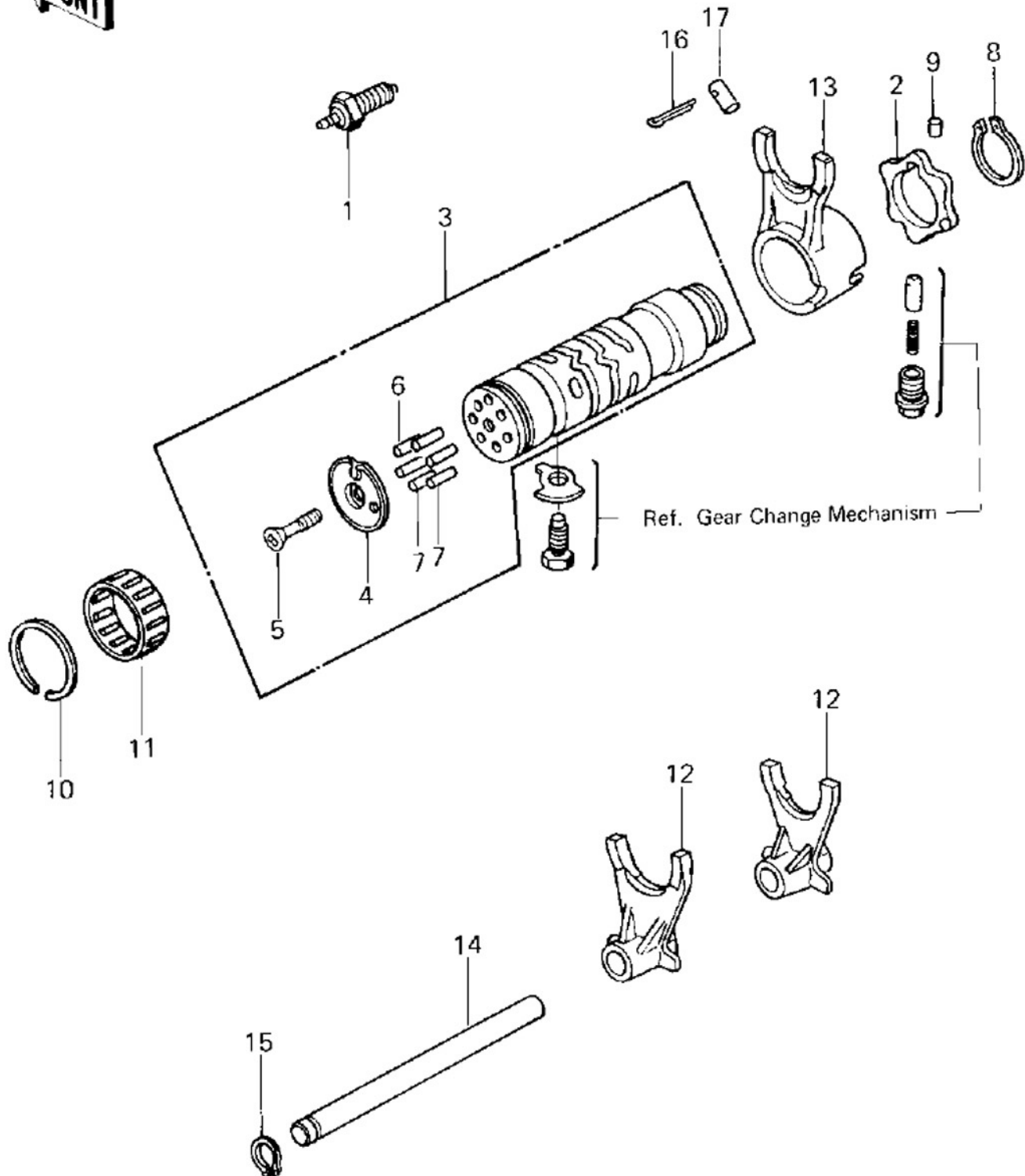









Ref #	Part #	Description	Qty	Spec Code
1	11034-1468 	BRACKET,FRONT BRAKE	1	
2	43015-1051 	CYLINDER ASSY,MASTER	1	
3	14008-1007 	LINER,PISTON	1	
4	27010-1028 	SWITCH,BRAKE	1	
5	43020-1027 	PISTON-COMP-BRAKE	1	
6	43022-1001 	STOPER,PISTON	1	
7	43026-1006 	CAP,OIL CUP	1	
8	43028-1008 	DIAPHRAGM	1	
9	312B0600 	NUT 6MM	1	
10	43033-003 	BOLT,HEX HEAD,6X25	2	
11	43034-1001 	HOLDER,MASTER CYLINDR	1	
12	46092-1010 	LEVER,FRONT BRAKE	1	
13	49016-1010 	DUST COVER	1	
14	92001-1055 	SCREW,COUNTERSUNK HED	2	
15	92001-1056 	BOLT,CLUTCH LEV FITT	1	
16	43059-1048 	HOSE,BRAKE,L=830	1	
17	43064-006 	DAMPER RUBBER,CYL HSE	1	
18	92002-1888 	BOLT,OIL,L=23	2	
19	43067-001 	WASHER-OIL BOLT	4	
20	49006-1041 	BOOT,DUST	1	



Ref #	Part #	Description	Qty	Spec Code
1	51001-5037-7Z 	TANK-FUEL,L.D.BLUE	1	
1	51001-5059-4U 	TANK-FUEL,C.E.GREEN	1	
2	11034-1125 	BRACKET,IGNITION COIL	2	
3	92075-101 	DAMPER RUBBER-FL TANK	2	
4	92075-1033 	DAMPER,IGNITION COIL	2	
5	92075-295 	DAMPER RUBBER FUEL TA	1	
6	51048-012 	CAP,FUEL TANK	1	
7	51059-008 	GASKET-FUEL TANK CAP	1	
8	92043-126 	PIN,HOOK	1	
9	92043-127 	PIN,CAP HINGE	1	
10	51023-1023 	TAP ASSY,FUEL	1	
11	220B0308 	SCREW PAN HEAD 3X8	2	
12	11009-1194 	GASKET,TAP VALVE	1	
13	51039-010 	"O" RING	1	
14	11009-1045 	GASKET,DRAIN BOLT	1	
15	92001-1089 	BOLT,DRAIN	1	
16	43028-1015 	DIAPHRAGM ASSY,TAP	1	
17	670B1504 	"O" RING,4MM	1	
18	92081-1171 	SPRING,TAP	1	
19	16146-1005 	COVER ASSY,TAP	1	
20	221B0412A 	SCREW CNTSNK HD 4X12	4	
21	92055-1027 	"O" RING,TAP LEVER	1	
22	92001-1091 	BOLT,6X20,FUEL TAP	2	
23	92022-183 	WASHER-PLAIN	2	

FRONT









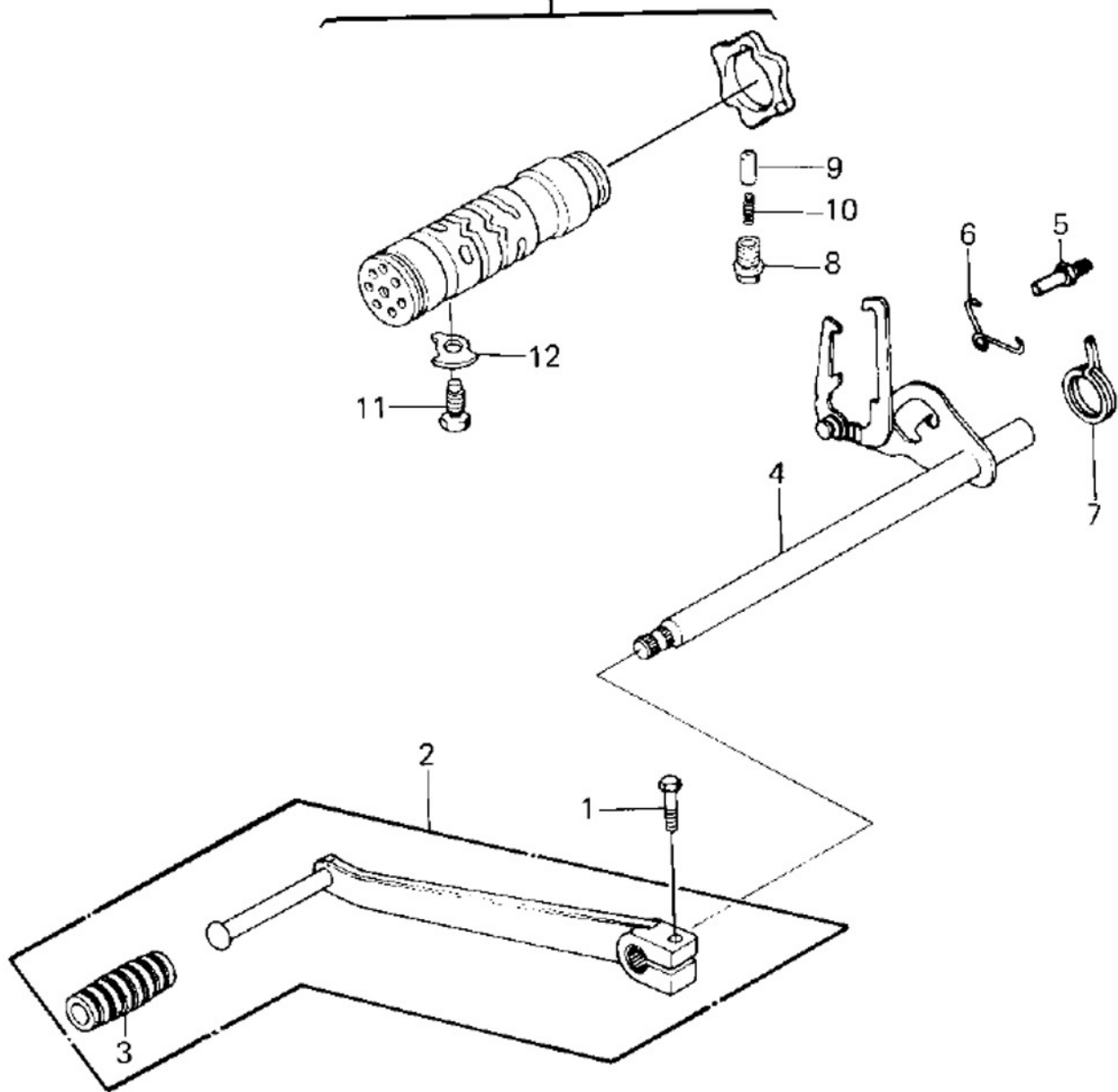

Ref #	Part #	Description	Qty	Spec Code
1	13151-5002 	SWITCH,NEUTRAL	1	
2	13145-1058 	CAM-CHANGE DRUM	1	
3	13239-1069 	DRUM-ASSY-CHANGE	1	
4	13091-1104 	HOLDER,CHANGE DRUM PI	1	
5	221B0620 	SCREW CNTSNK HD 6X20	1	
6	92042-014 	PIN GEAR CHANGE DRUM	1	
7	92042-030 	PIN,GEAR CHNGE DRUM	5	
8	480J3000 	CIRCLIP,30MM	1	
9	610A0406 	PIN-DOWEL,4X6	1	
10	92033-035 	CIRCLIP,37MM	1	
11	92046-051 	BRG,NEDL,37BTM4312	1	
12	13140-1008 	SHIFT FORK,LOW,2&3RD	2	
13	13140-1009 	SHIFT FORK,4TH & TOP	1	
14	49047-5003 	ROD-SHIFT	1	
15	480J1200 	CIRCLIP 12MM	1	
16	550D3020 	PIN COTTER 3.0X20	1	
17	92042-021 	DOWEL PIN,8X18	1	

FRONT





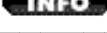
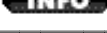
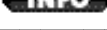



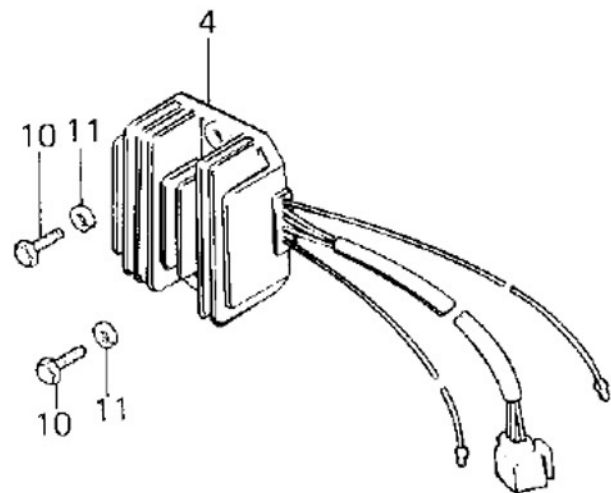
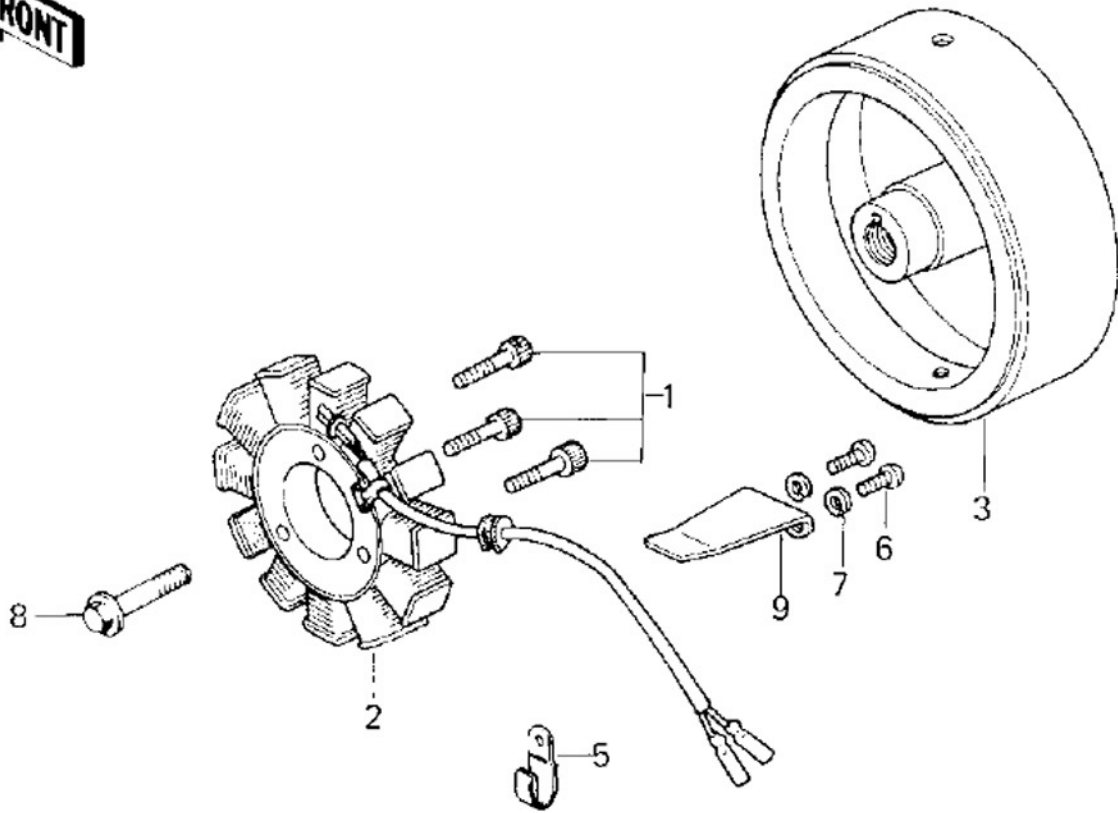

Ref. Change Drum







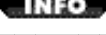



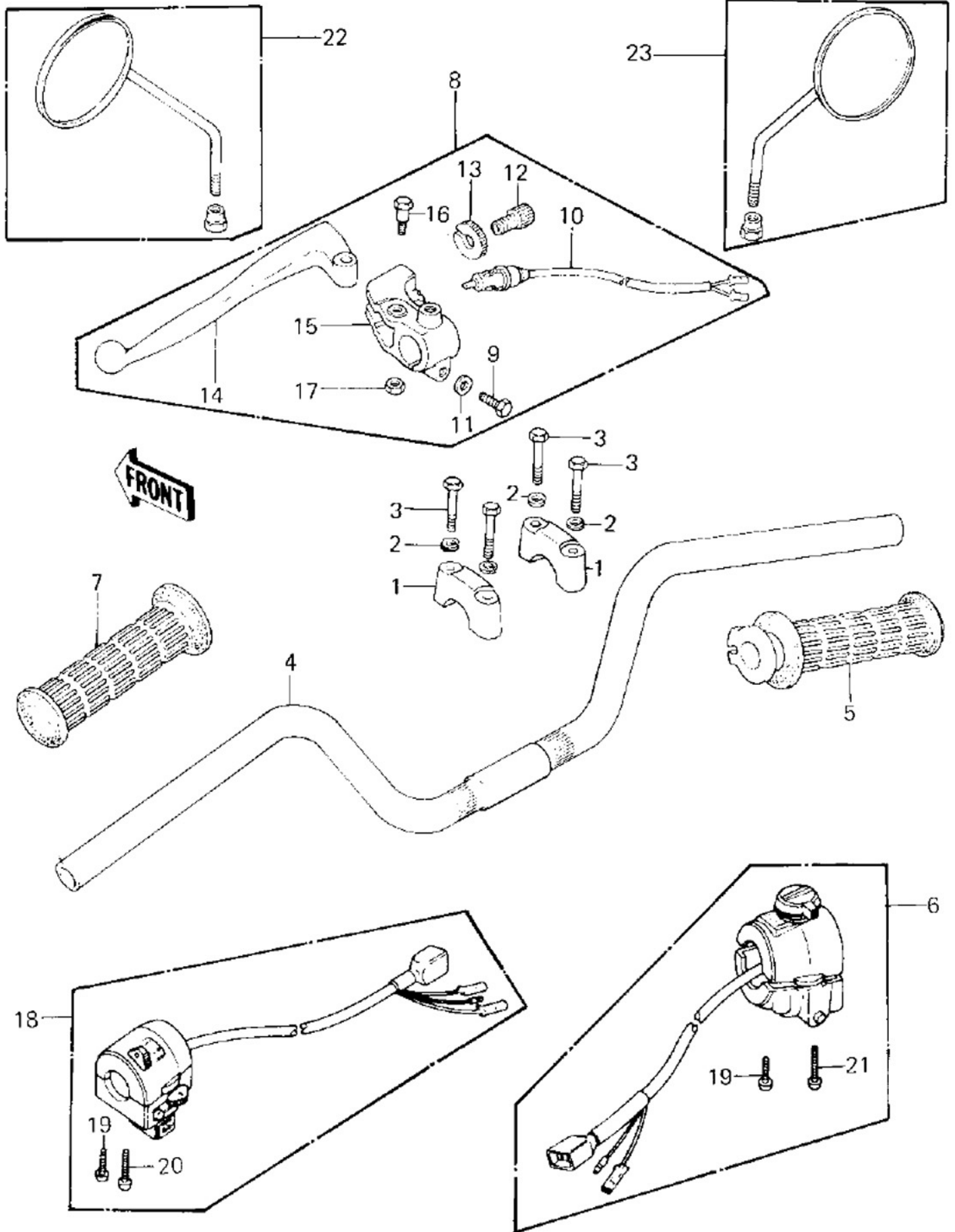





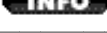

Ref #	Part #	Description	Qty	Spec Code
1	112G0620 	BOLT-UPSET,6X20	1	
2	13242-022 	PEDAL ASSY,GEAR SHIFT	1	
3	92160-1036 	DAMPER,CHANGE PEDAL	1	
4	13161-042 	LEVER ASSY,GEAR SFT	1	
5	92001-1401 	BOLT,RETURN SPRING	1	
6	92083-018 	SPRING,KICK PAWL	1	
7	92083-028 	SPRING,CHG PEDL RTRN	1	
8	92001-1037 	BOLT,NEUTRAL POSITION	1	
9	92043-076 	PIN-NEUTRAL POSITION	1	
10	92081-112 	SPRING	1	
11	92001-174 	BOLT,HEX HEAD,10X26	1	
12	92024-074 	WASHER,LOCK,10MM	1	

FRONT

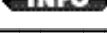
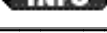
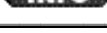
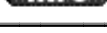



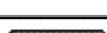





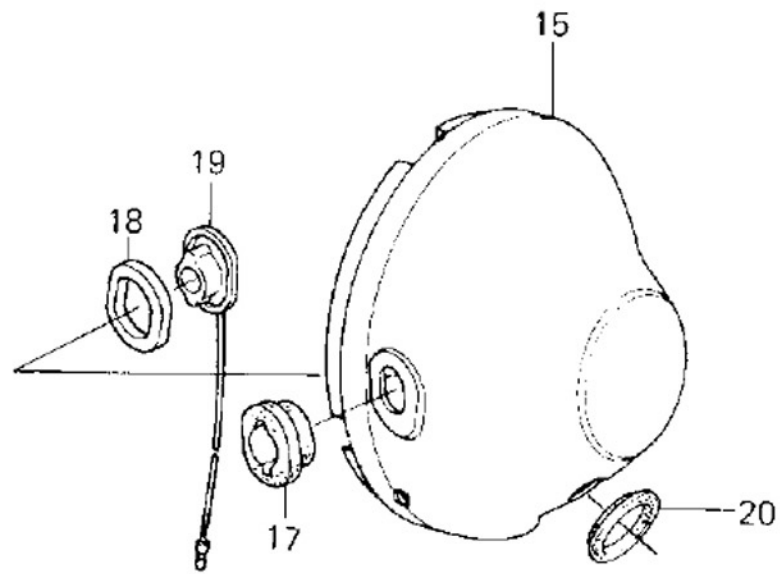
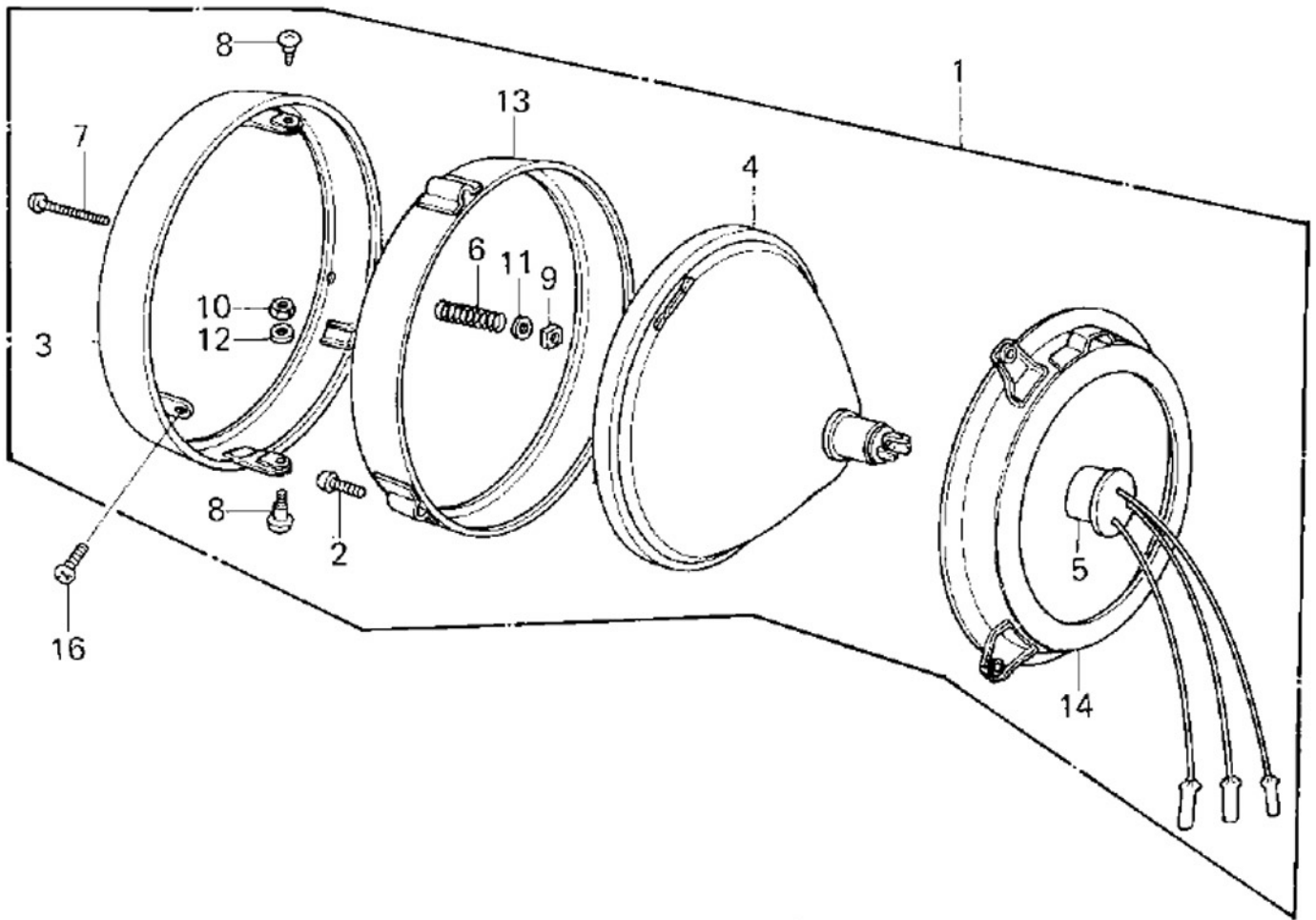



Ref #	Part #	Description	Qty	Spec Code
1	120P0530 	BOLT-SOCKET,5X30	3	
2	21003-1005 	STATOR	1	
3	21050-1003 	FLYWHEEL	1	
4	21066-1014 	REGULATOR,VOLTAGE	1	
5	21126-008 	CLAMP,WIRING HARNESS	1	
6	220B0512 	SCREW PAN HEAD 5X12	2	
7	461F0500 	WASHER SPRING 5MM	2	
8	92001-1201 	BOLT,10X40	1	
9	92037-1122 	CLAMP,GENERATOR WIRE	1	
10	112G0616 	BOLT-UPSET,6X16	2	
11	461F0600 	WASHER SPRING 6MM	2	





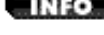
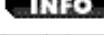
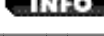
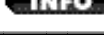
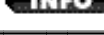
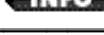
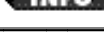
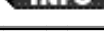
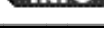
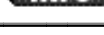

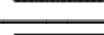

















Ref #	Part #	Description	Qty	Spec Code
1	46012-008 	HOLDER-HANDLEBAR	2	
2	461F0800 	WASHER SPRING 8MM	4	
3	92001-1405 	BOLT 8X38	4	
4	46003-1026 	HANDLEBAR	1	
5	46019-038 	GRIP ASSY,THROTTLE	1	
6	46091-1047 	HOUSING ASSY,CONT,R.H	1	
7	46075-028 	RUBBER,L.H GRIP	1	
8	46076-054 	LEVER ASSY,CLUTCH	1	
9	110N0625 	BOLT HEX HEAD 6X25	1	
10	27043-002 	SWITCH,CLUTCH	1	
11	410B0600 	WASHER PLAIN 6MM	1	
12	46055-003 	SCREW CABLE ADJUST	1	
13	46056-007 	NUT,CABLE ADJUST NUT	1	
14	46092-023 	LEVER,CLUTCH	1	
15	46094-019 	HOLDER,CLUTCH LEVER	1	
16	92007-047 	BOLT,HEX HEAD	1	
17	92017-014 	NUT,LOCK 6MM	1	
18	46091-1048 	HOUSING ASSY,CONT,L.H	1	
19	220B0530 	SCREW PAN HEAD 5X30	2	
20	220B0535 	SCREW-PAN-CROS	1	
21	220B0540 	SCREW-PAN-CROS	1	
22	56003-019 	REAR VIEW MIRROR,L.H	1	
23	56002-029 	REAR VIEW MIRROR,R.H	1	









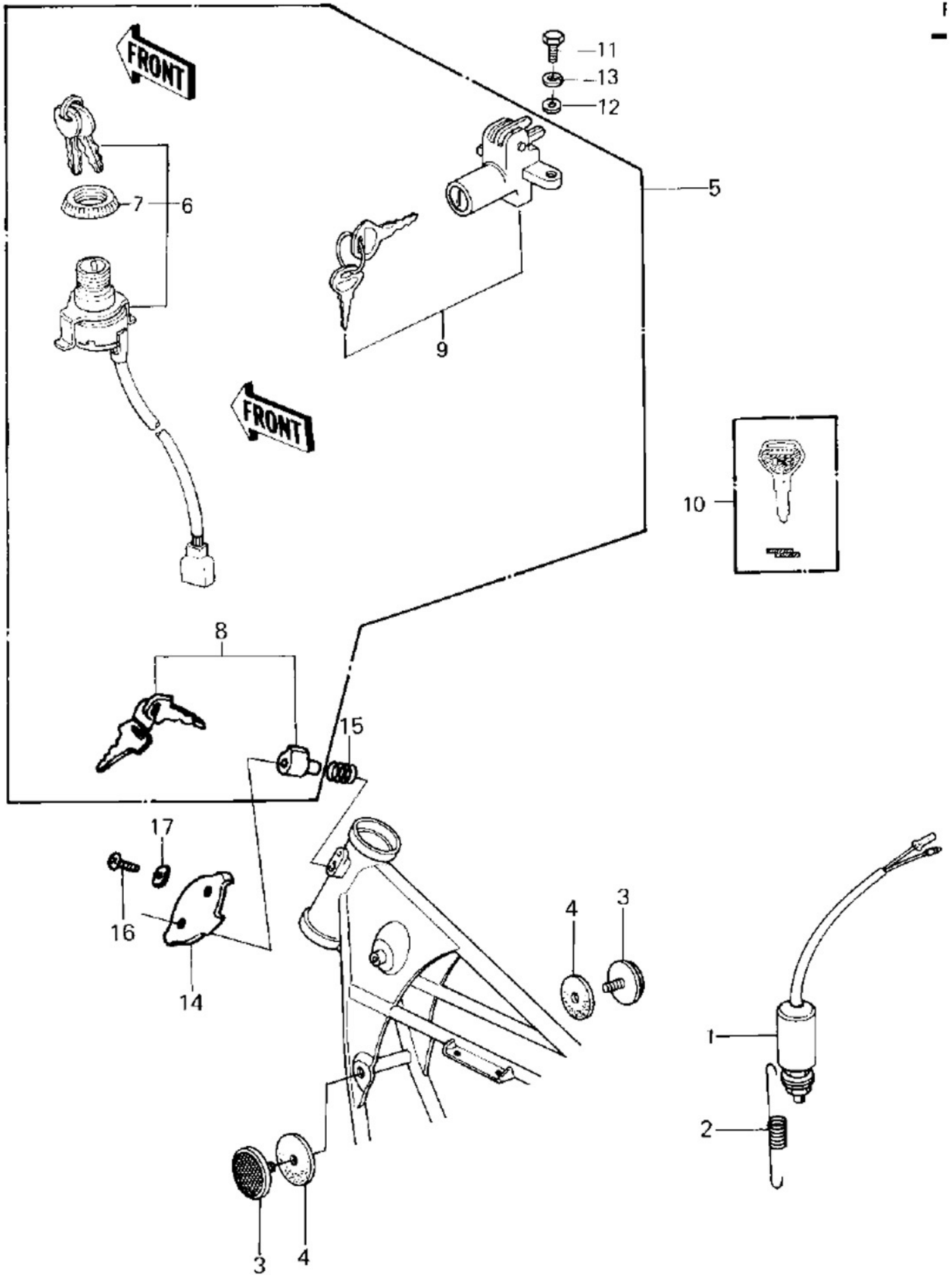







FRONT



Ref #	Part #	Description	Qty	Spec Code
1	23003-017 	LAMP UNIT,HEAD	1	
2	220B0312 	SCREW PAN HEAD 3X12	2	
3	23006-038 	RIM,HEAD LAMP	1	
4	23007-041 	SEALD BEAM UNIT	1	
5	23008-037 	SOCKET ASSY,HEAD LAMP	1	
6	23014-005 	SPRING FOCUS ADJUST	1	
7	23019-021 	SCREW FORCUS ADJUST	1	
8	23019-023 	SCREW-PAN HEAD,5X12	2	
9	23020-018 	NUT,4MM	1	
10	23020-023 	NUT,HEAD LAMP RIM FIT	2	
11	23021-004 	WASHER	1	
12	23021-012 	WASHER-PLAIN,5MM	2	
13	23072-001 	RING,HEAD LAMP MOUNT	1	
14	23074-001 	RING,HEAD LAMP MOUNT	1	
15	23005-1015-21 	BODY-COMP-HEAD LAMP	1	
16	23019-022 	SCREW,PAN HEAD,5X14	2	
17	23066-015 	DAMPER RUBBER	2	
18	23066-016 	DAMPER RUBBER	2	
19	23076-005 	COLLAR	2	
20	92071-1008 	GROMMET	1	









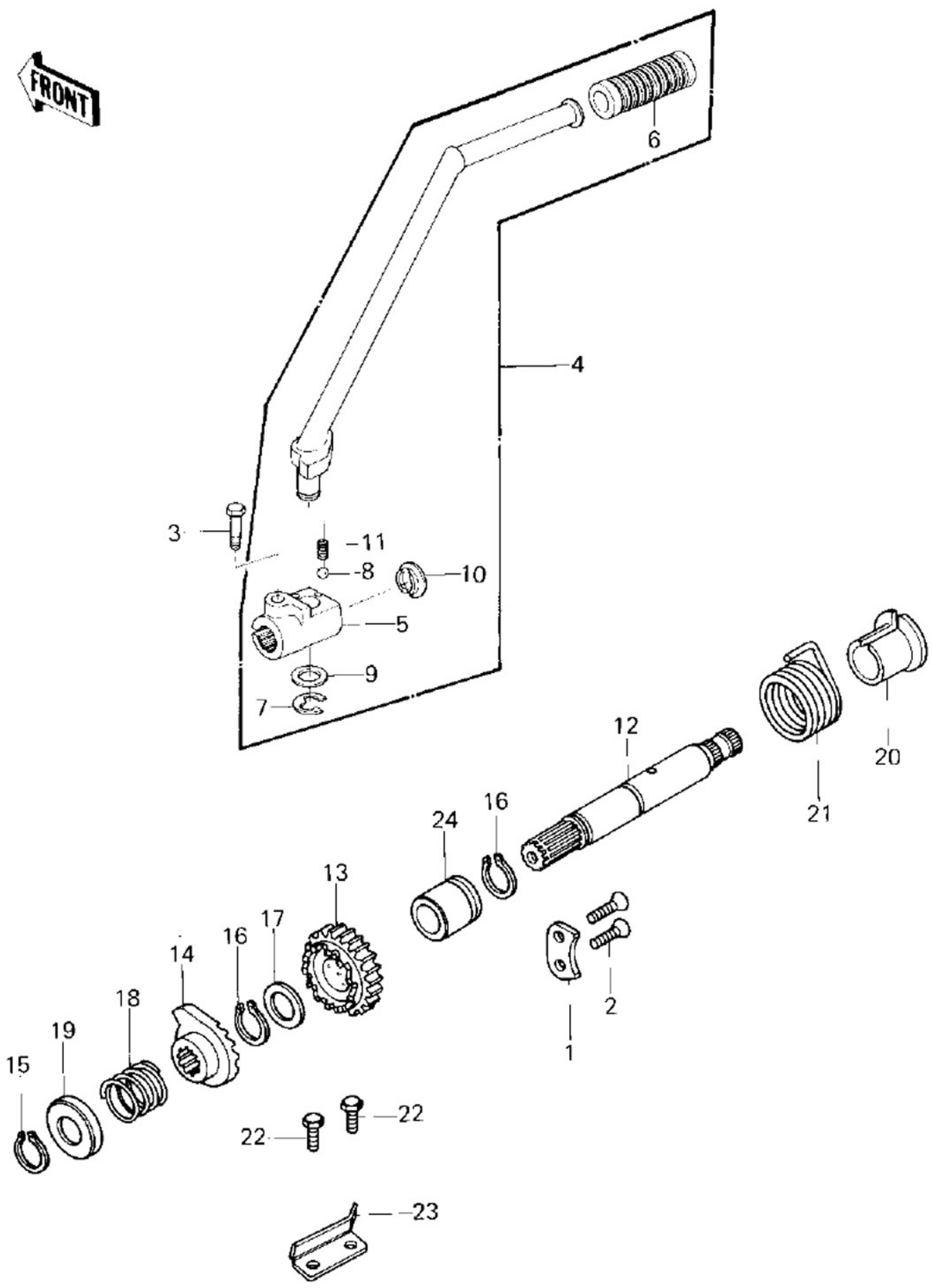







Ref #	Part #	Description	Qty	Spec Code
1	92001-1397 	BOLT-8X63	1	
2	21008-1012 	BREAKER ASSY,CONTACT	1	
3	21008-028 	BREAKER,CONTACT	1	
4	21008-027 	BREAKER,CONTACT	1	
5	220B0406 	SCREW PAN HEAD 4X6	5	
6	461F0400 	WASHER SPRING 4MM	5	
7	410B0400 	WASHER PLAIN 4MM	4	
8	21019-005 	FELT OIL	1	
9	21013-037 	CONDENSER	1	
10	26001-1081 	WIRING HARNESS,BREAKR	1	
11	21126-008 	CLAMP,WIRING HARNESS	2	
12	21148-011 	ADVANCER,AUTMATIC TMNG	1	
13	21121-1001 	COIL,IGNITION,#1.4	1	
14	21121-1002 	COIL,IGNITION,#2.3	1	
15	21130-1007 	CAP-SPARK PLUG,RTFM20	4	
16	21131-004 	GROMMET-PLUG CAP,A	4	
17	21132-005 	GROMMET,SPARK PLG CAP	4	
18	220B0512 	SCREW PAN HEAD 5X12	3	
19	92022-244 	WASHER,SPARK ADVANCER	1	
20	B7ES 	SPARK PLUG B7ES	4	
20	B8ES 	SPARK PLUG B8ES	4	
21	92015-1078 	NUT-6MM	4	
22	21160-005 	CAP,SPARK PLUG	4	USE FOR CANADIAN MARKET



Ref #	Part #	Description	Qty	Spec Code
1	27010-017 	SWITCH-BRAKE LAMP	1	
2	27011-009 	SPRING BRAKE LAMP SW	1	
3	28012-016 	REFLECTOR,REFLEX	2	
4	92094-011 	DAMPER RUBBER,REFLECT	2	
5	27004-5020 	LOCK SET,KZ650B3	1	
6	27005-5007 	SWITCH ASSY,IGNITION	1	
7	27007-004 	NUT,IGNITION SW LOCK	1	
8	27016-5009 	LOCK-ASSY,STEERING	1	
9	27016-5010 	LOCK-ASSY,SEAT	1	
10	27008-1103 	KEY-LOCK,BLANK	1	
11	112B0614 	BOLT-UPSET 6X14	1	
12	411B0600 	WASHER PLAIN 6MM	1	
13	461F0600 	WASHER SPRING 6MM	1	
14	11012-1134 	CAP,STEERING LOCK	1	
15	27032-001 	SPRING-STEERING LOCK	1	
16	92008-007 	SCREW-TAPPING	1	
17	92097-003 	WASHER	1	





FRONT

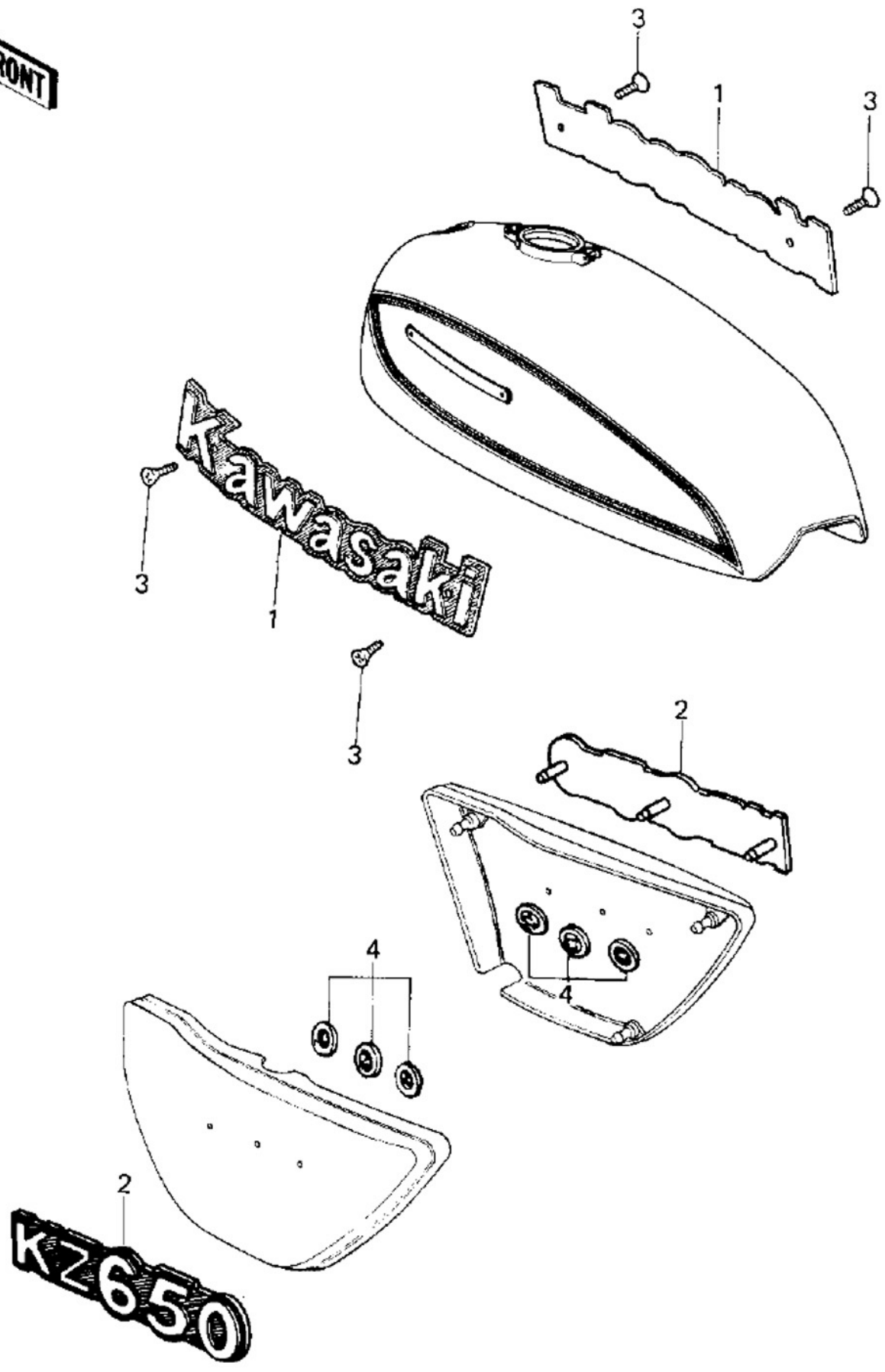

Ref #	Part #	Description	Qty	Spec Code
1	13169-007 	PLATE-DRUM LEV POSTON	1	
2	221B0612 	SCREW CNTSNK HD 6X12	2	
3	115B0832 	BOLT-SMALL-UPSET	1	
4	13064-1005 	PEDAL ASSY,KICK	1	
5	13061-1008 	BOSS,KICK	1	
6	13063-004 	RUBBER KICK PEDAL	1	
7	482J0100 	CIRCLIP 10MM	1	
8	600A0800 	BALL STEEL 1/4'	1	
9	92022-1019 	WASHER,PLAIN	1	
10	92066-058 	PLUG,A,KICKSTARTER	1	
11	92081-154 	SPRING	1	
12	13066-045 	SHAFT,KICKSTARTER	1	
13	13068-035 	GEAR,KICKSTARTER,20T	1	
14	13078-011 	RATCHET,KICK SHAFT	1	
15	480J1900 	CIRCLIP,19MM	1	
16	480J2000 	CIRCLIP, 20MM	2	
17	92022-112 	WASHER THRUST	1	
18	92081-104 	SPRING RATCHET	1	
19	92102-008 	CAP,KICKSTARTER	1	
20	13070-009 	GUIDE,KICK SPRING	1	
21	92082-006 	SPRING,KICK RETURN	1	
22	112G0614 	BOLT-UPSET	2	
23	13072-018 	STOPPER,KICKSTARTER	1	
24	92028-175 	BUSHING,KICK SHAFT	1	

FRONT





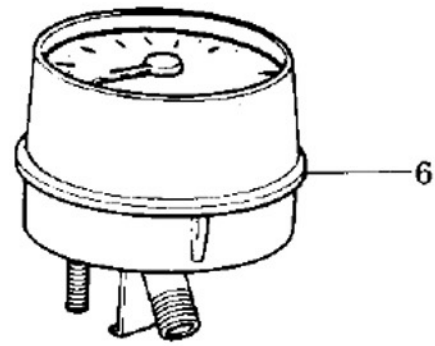
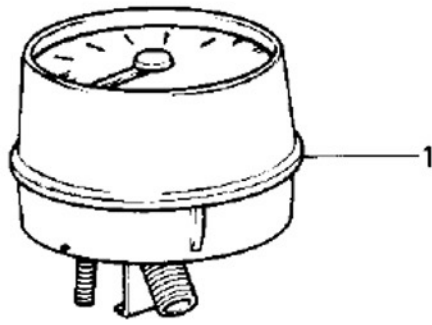





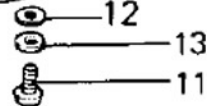
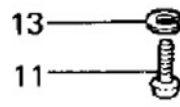
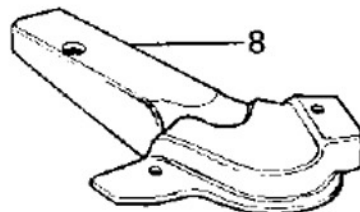
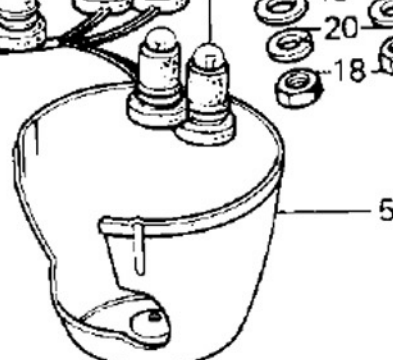
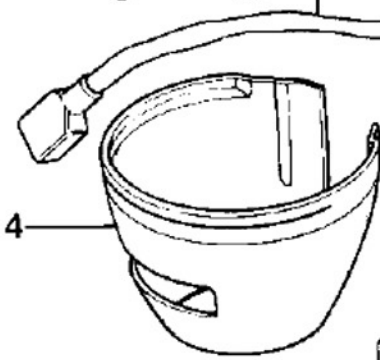
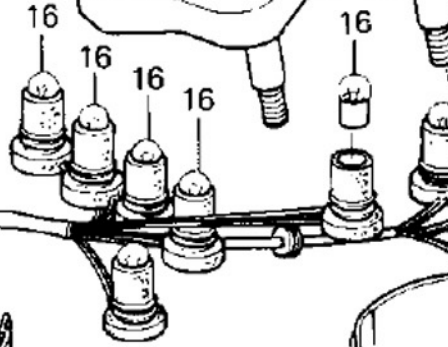
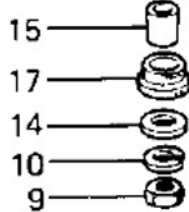
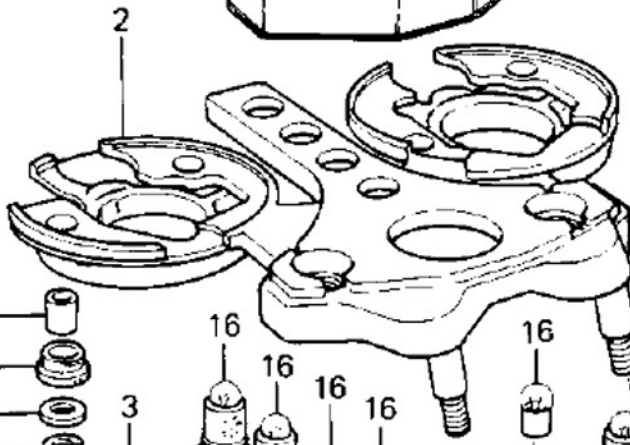
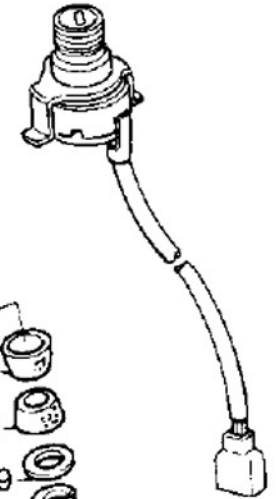
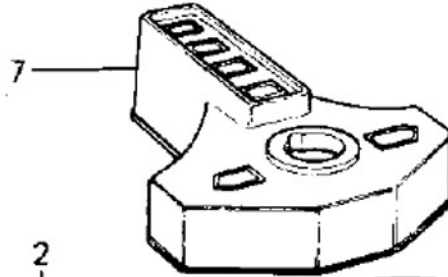













Ref #	Part #	Description	Qty	Spec Code
1	56014-1037 	EMBLEM,FUEL TANK	2	
2	56018-1063 	MARK,SIDE COVER	2	
3	221C0306 	SCREW-CSK-CROS	4	
4	92018-005 	NUT,LOCK,3MM	6	











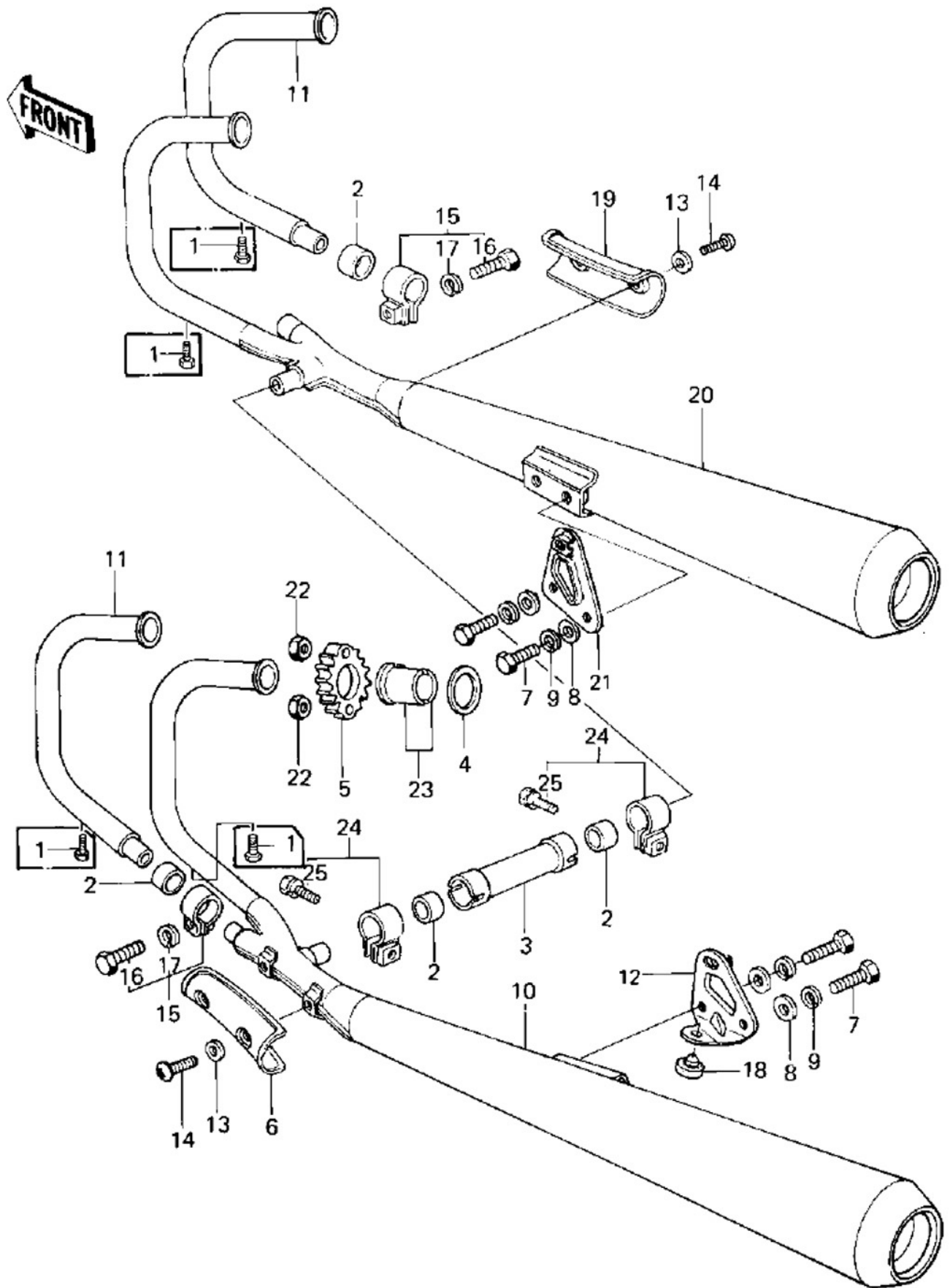



Ref. Ignition Switch

FRONT



Ref #	Part #	Description	Qty	Spec Code
1	25005-1068 	SPEEDOMETER ASSY,MPH	1	
1	25005-1013 	SPEEDOMETER ASSY,KPH (Canada)	1	CANADA
2	25008-045 	BRACKET,METER	1	
3	25011-049 	SOCKET,SPEEDOMETER	1	
4	25012-010 	COVER,SPEEDOMETER	1	
5	25012-011 	COVER,TACHOMETER	1	
6	25015-1011 	TACHOMETER ASSY	1	
7	25023-015 	COVER,METER,INDICATER	1	
8	25024-006 	COVER,METER BRACKET	1	
9	312B0500 	NUT 5MM	4	
10	461F0500 	WASHER SPRING 5MM	4	
11	220B0308 	SCREW PAN HEAD 3X8	5	
12	410B0300 	WASHER PLAIN 3MM	3	
13	461F0300 	WASHER SPRING 3MM	5	
14	92022-241 	WASHER,PLAIN,5MM	4	
15	92027-211 	COLLAR,METER	4	
16	92069-018 	BULB 12V 3W	10	
17	92075-172 	RUBBER,METER	4	
18	311B0800 	NUT,8MM	2	
19	411B0800 	WASHER PLAIN 8MM	2	
20	461F0800 	WASHER SPRING 8MM	2	
21	92075-080 	DAMPER RUBBER	4	



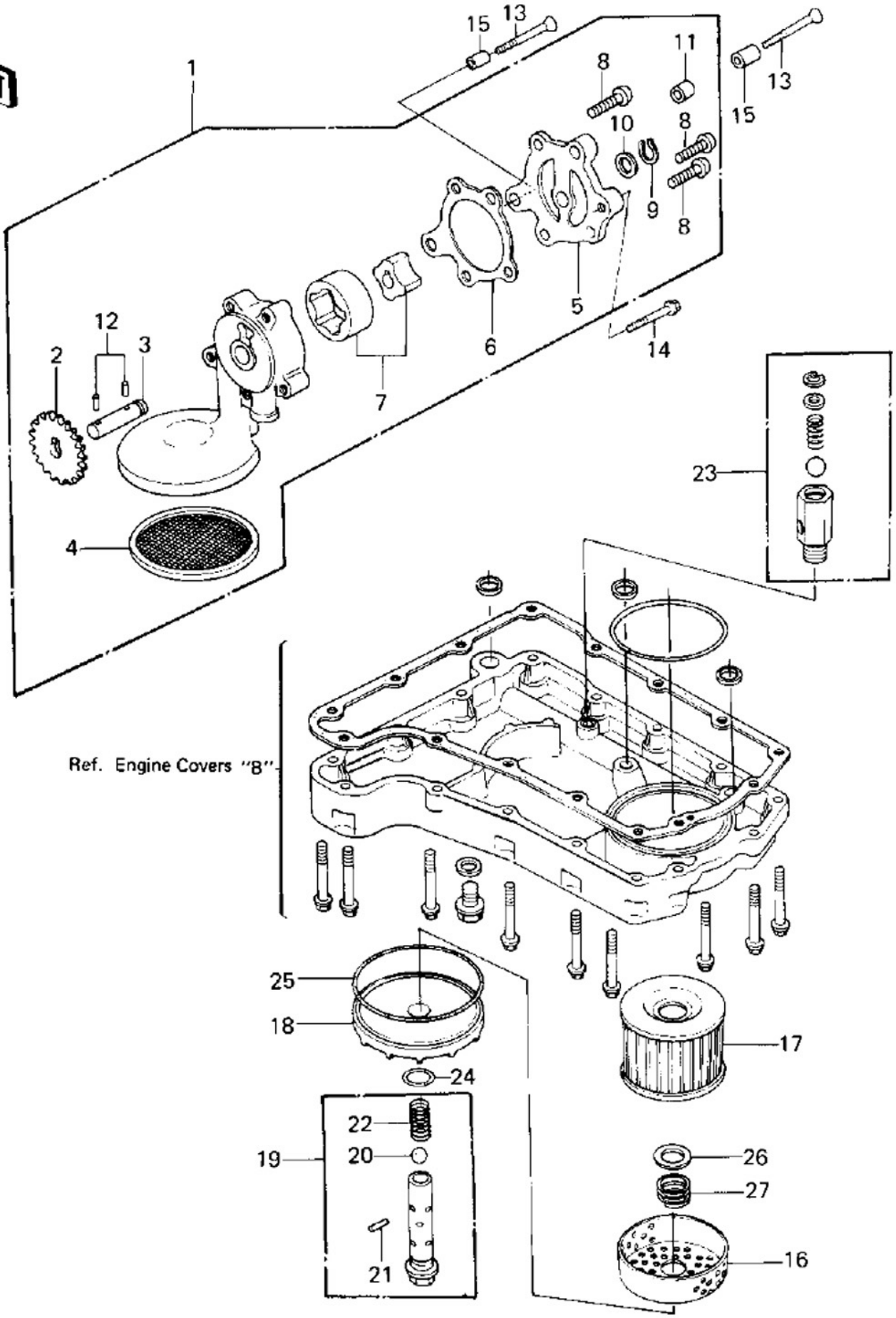

Ref #	Part #	Description	Qty	Spec Code
1	110R0610 	BOLT (6X10)	4	
2	11060-1051 	GASKET,MUFFLER CONNECT	4	
3	32032-1669 	PIPE,MUFFLER CONNECTION	1	
4	11009-1866 	GASKET,EXHAUST PIPE H	4	
5	18069-1006 	HOLDER,EXHAUST PIPE	4	
6	14025-1099 	COVER,MUFFLER,L.H.	1	
7	115G0816 	BOLT-SMALL-UPSET,8X16	4	
8	411B0800 	WASHER PLAIN 8MM	4	
9	461F0800 	WASHER SPRING 8MM	4	
10	18001-1002 	MUFFLER ASSY,L.H	1	
10	18001-1002 	MUFFLER ASSY,L.H	1	
11	18049-1013 	PIPE,EXHAUST,#1	2	
11	18049-1397 	PIPE-EXHAUST,#4	2	
12	32069-1040 	BRACKET,MUFFLER,L.H.	1	
13	411D0600 	WASHER-PLAIN,6MM	4	
14	92011-039 	SCREW,PAN HEAD,6X8	4	
15	92037-1220 	CLAMP,MUFFLER	2	
16	115G0825 	BOLT-SMALL-UPSET 8X25	2	
17	461F0800 	WASHER SPRING 8MM	2	
18	92075-015 	DAMPER RUBB MAIN STAD	1	
19	14025-1100 	COVER,MUFFLER,R.H.	1	
20	18001-1003 	MUFFLER ASSY,R.H	1	
20	18001-1003 	MUFFLER ASSY,R.H	1	
21	32069-1039 	BRACKET,MUFFLER,R.H.	1	
22	92017-014 	NUT,LOCK 6MM	8	
23	92027-264 	COLLAR,EXHAUST PIPE	8	
24	92037-1223 	CLAMP,PIPE,35MM	2	
25	92001-1379 	BOLT,8X30	2	

FRONT



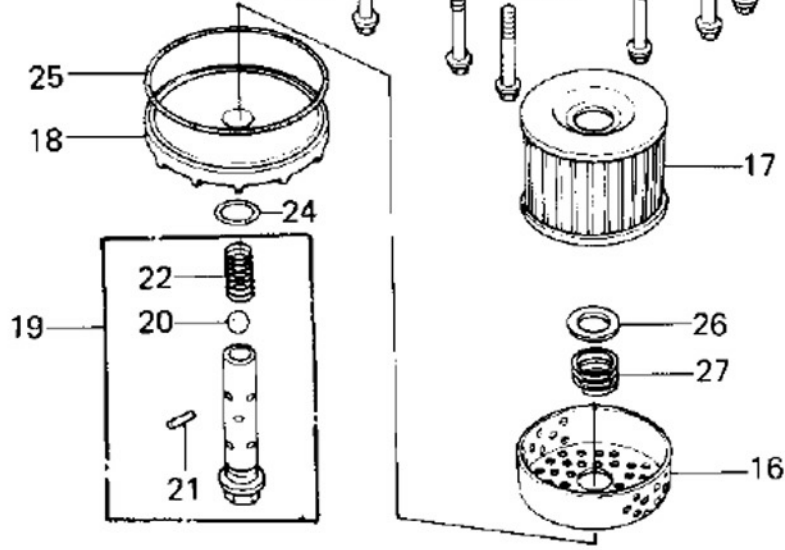





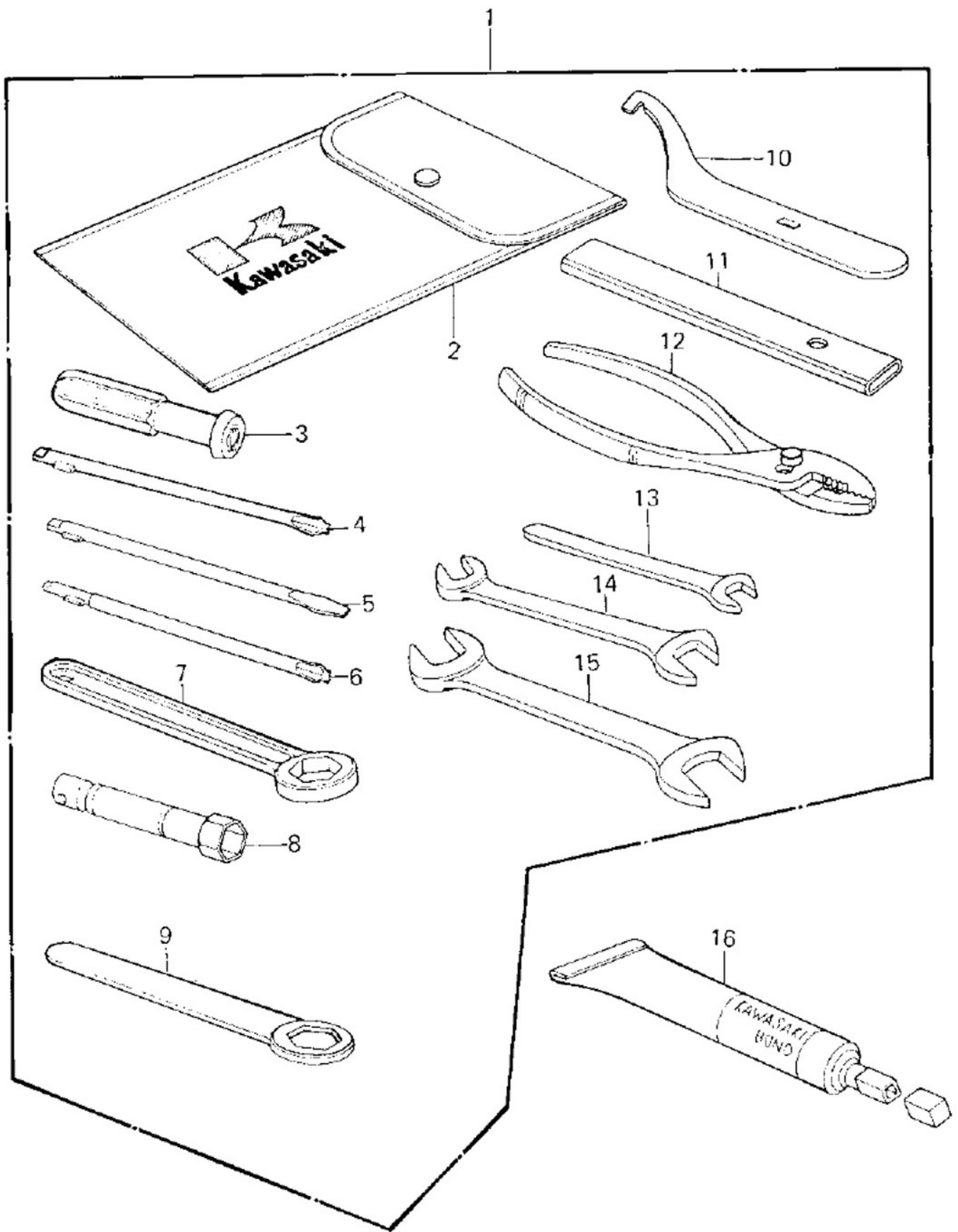









Ref. Engine Covers "8"



Ref #	Part #	Description	Qty	Spec Code
1	16082-064 	OIL PUMP ASSY	1	
2	16085-025 	GEAR,OIL PUMP,57T	1	
3	16086-004 	SHAFT,OIL PUMP	1	
4	16111-004 	STRAINER,OIL PUMP	1	
5	16142-005 	COVER,OIL PUMP	1	
6	16145-004 	GASKET,OIL PUMP COVER	1	
7	16154-003 	ROTOR ASSY,OIL PUMP	1	
8	220B0622 	SCREW PAN HEAD 6X22	3	
9	480J1100 	CIRCLIP,11MM	1	
10	92022-311 	WASHER,PLAIN	1	
11	92043-1302 	PIN,DOWEL,8X10	1	
12	92042-041 	PIN,DOWEL	2	
13	221B0650 	SCREW,CONTRUNK HEAD	2	
14	92001-165 	BOLT,HEX HEAD,6X45	1	
15	92042-050 	PIN,DOWEL,6.2X8X28	2	
16	13169-1110 	PLATE,OIL FILTER	1	
17	16099-003 	FILTER,OIL	1	
18	16101-004 	COVER,OIL FILTER	1	
19	16126-1108 	VALVE,OIL FILTER	1	
20	600A1200 	BALL STEEL 3/8'	1	
21	92043-111 	SPRING PIN	1	
22	92081-109 	SPRING	1	
23	16130-1001 	RELEAF VALVE ASSY	1	
24	670B2016 	"0" RING,16MM	1	
25	671B2590 	"0" RING,90MM	1	
26	92022-1012 	WASHER,20.5X30X1.0	1	
27	92081-1018 	SPRING,OIL FILTER	1	



Ref #	Part #	Description	Qty	Spec Code
1	56007-1044 	TOOL KIT	1	
2	56008-009 	BAG,TOOL	1	
3	92106-1001 	GRIP,SCREW DRIVER	1	
4	92107-1052 	TOOL-DRIVER	1	
5	92107-007 	92107-1052 (Canada)	1	
6	92107-008 	92107-1002 (Canada)	1	
7	92110-1147 	TOOL-WRENCH,BOX END,2	1	
8	92108-008 	WRENCH,SPARK PLUG	1	
9	92110-1151 	TOOL-WRENCH,BOX END,1	1	
10	92110-1034 	WRENCH,HOOK,41M/M	1	
11	92111-004 	WRENCH,HOOK,41M/M	1	
12	92112-005 	92112-003 (Canada)	1	
13	92110-1031 	WRENCH,OPEN END,10M/M	1	
14	92126-002 	WRENCH,OPEN END,12X13	1	
15	92110-1153 	TOOL-WRENCH,OPEN END,	1	
16	92104-002 	LIQUID GASKET	1	

This catalog covers:
'80 KZ650-F1 Chassis







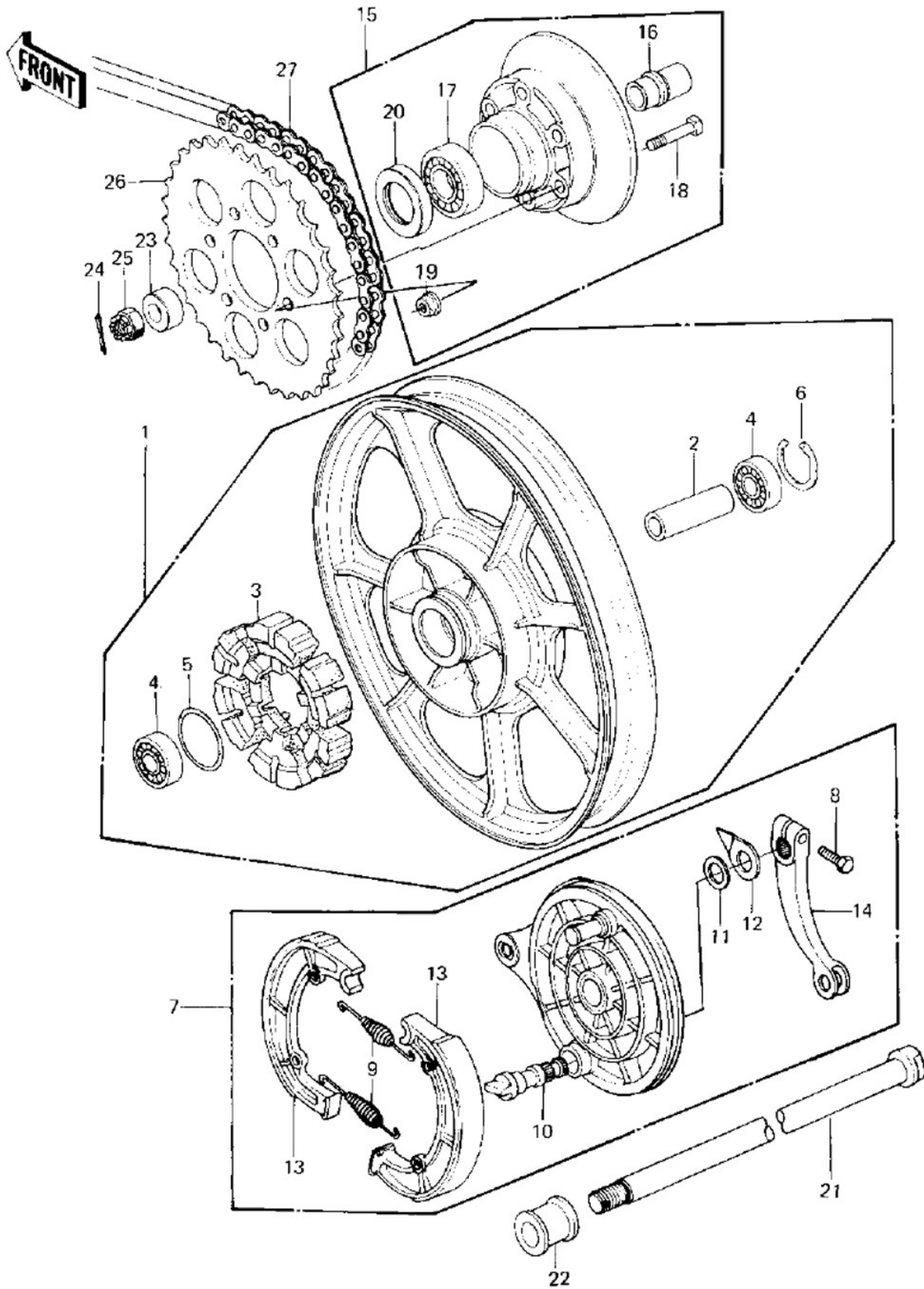







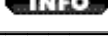
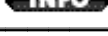
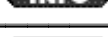
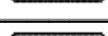







GRID NO.

F-5

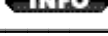
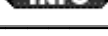
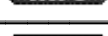
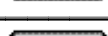
Ref. No.

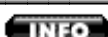

- 1
- 2
- 3
- 4
- 5
- 6
- 7
- 8
- 9
- 10
- 11
- 12
- 13
- 14
- 15
- 16
- 17
- 18
- 19
- 20
- 21
- 22
- 23
- 24
- 25
- 26
- 27

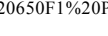

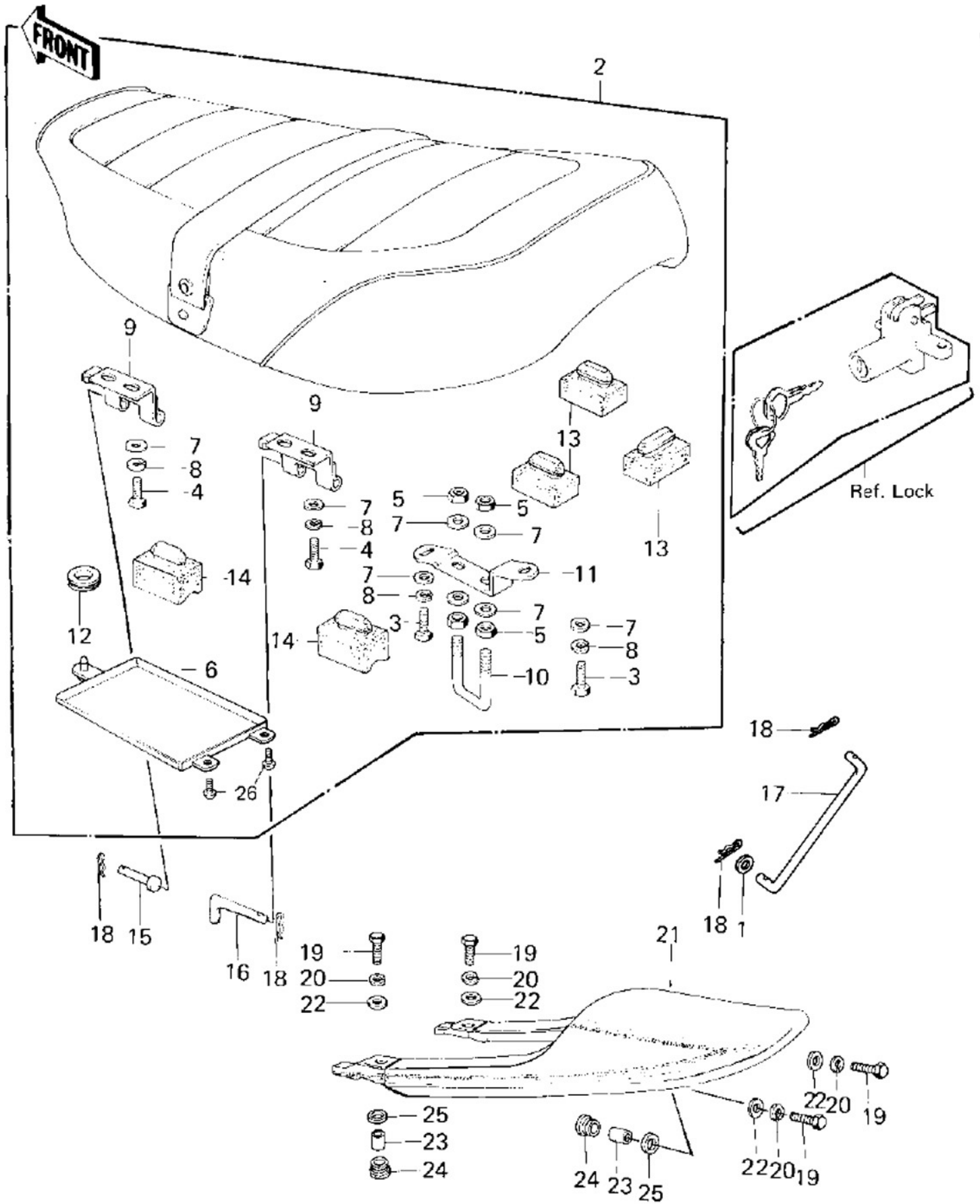





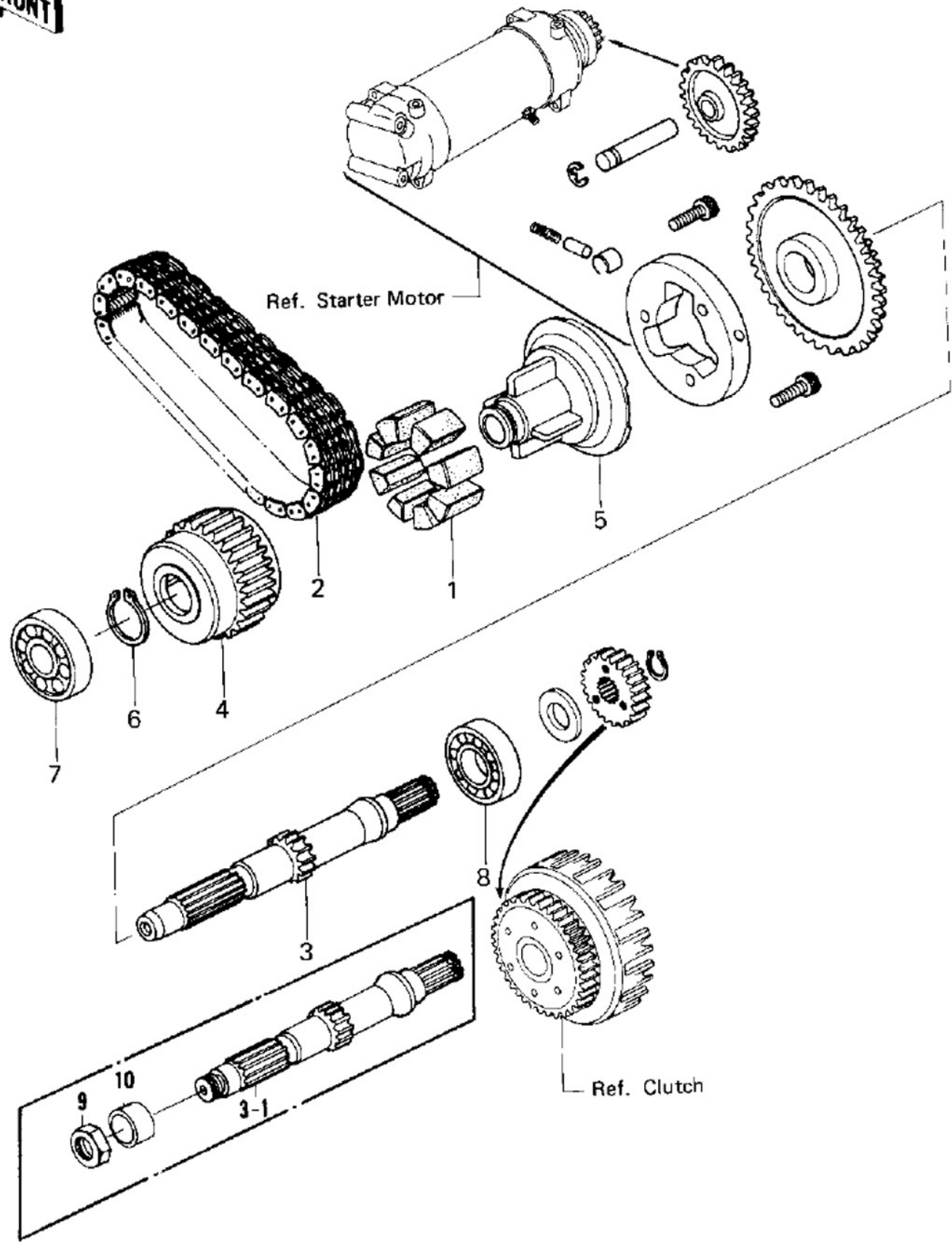



Ref #	Part #	Description	Qty	Spec Code
1	41073-1103 	SOLID WHEEL ASSY, RR	1	
2	42010-033 	SPACER, REAR HUB BEARING	1	
3	42014-026 	DAMPER,REAR HUB SHOCK	1	
4	601B6303ZZ 	BRG,BALL,#6303ZZC3	2	
5	671B2555 	"O" RING,55MM	1	
6	92033-1042 	CIRCLIP,47M/M	1	
7	41035-1056 	PANEL-ASY,RR BRK	1	F/NO. 000001~002240
7	41035-1056 	PANEL-ASY,RR BRK	AL	F/NO. 000001~002240
7	41035-1055 	PANEL-ASY,BRK BLACK	1	F/NO. 002241~007063
7	41035-1055 	PANEL-ASY,BRK BLACK	AL	F/NO. 002241~007063
8	114G0828 	BOLT HEX HEAD 8X28	1	
9	41049-012 	SPRING,BRAKE SHOE	2	
10	41050-017 	CAM SHAFT,BRAKE	1	
11	41051-003 	DUST SHIELD-BRAKE CAM	1	
12	41085-004 	INDICATOR,BRAKE SHOE	1	
13	42019-012 	SHOE,BRAKE	2	
14	42029-039 	LEVER REAR BRAKE CAM	1	
15	42008-032 	COUPLING ASSY,REAR HB	1	
16	42036-026 	SLEEVE,REAR HUB COUPL	1	
17	601B6305 	BEARING BALL #6305	1	
18	92003-087 	BOLT-REAR SPROCKET	6	
19	92015-1415 	NUT,10MM	6	
20	92050-076 	OIL,SEAL,#38629	1	
21	41068-1086 	AXLE,RR	1	
22	42032-017 	COLLAR REAR AXLE	1	
23	42032-067 	COLLAR,REAR AXLE,L.H.	1	
24	550D4035 	PIN-COTTER,4.0X35	1	
25	92015-055 	NUT CASTLE,16MM	1	
26	42041-065 	REAR SPROCKET 50T	1	
27	92057-1232 	CHAIN-EX50MV-0X102L	1	



Ref #	Part #		Description	Qty	Spec Code
1	410B0600	INFO	WASHER PLAIN 6MM	1	
2	53001-1194	INFO	SEAT-ASSY,DUAL,W/BAND	1	
3	112B0614	INFO	BOLT-UPSET 6X14	2	
4	112G0616	INFO	BOLT-UPSET,6X16	4	
5	311B0600	INFO	NUT 6MM	4	
6	32099-011	INFO	CASE	1	
7	411B0600	INFO	WASHER PLAIN 6MM	10	
8	461F0600	INFO	WASHER SPRING 6MM	6	
9	53009-031	INFO	HINGE,FRONT	2	
10	53056-002	INFO	CATCH, SEAT	1	
11	53058-004	INFO	BRACKET,SEAT CATCH	1	
12	92071-056	INFO	GROMMET	1	
13	92075-099	INFO	DAMPER RUBBER	3	
14	92075-156	INFO	DAMPER RUBBER-SEAT	2	
15	53011-002	INFO	PIN	1	
16	53011-008	INFO	PIN,DUAL SEAT PIVOT	1	
17	53054-006	INFO	STOPPER,SEAT	1	
18	554A0600	INFO	PIN,SNAP	4	
19	112G0625	INFO	BOLT-UPSET	4	
20	461F0600	INFO	WASHER SPRING 6MM	4	
21	14025-5019-7Z	INFO	COVER,SEAT,L.D.BLUE	1	
21	14025-5026-4U	INFO	COVER,SEAT,C.E.GREEN	1	(CANADA ONLY)
22	92022-228	INFO	WASHER,PLAIN,7MM	4	
23	92027-241	INFO	COLLAR	4	
24	92075-174	INFO	RUBBER,FENDER COVER	4	
25	92075-175	INFO	DAMPER RUBBER	4	
26	220B0510	INFO	SCREW PAN HEAD 5X10	2	

FRONT



Ref #	Part #	Description	Qty	Spec Code
1	13098-029 	DAMPER RUBBER	8	
2	13122-007 	CHAIN,PRIMARY 52L	1	
3	13127-054 	SHAFT,SECONDARY	1	E/NO. 014501~118270
3-1	13127-1019 	SHAFT,SECONDARY	1	E/NO. 118271~123772
4	13252-001 	COUPLING,OUTER	1	
5	13253-001 	COUPLING,INNER	1	
6	480J2800 	CIRCLIP 28MM	1	
7	601B6304 	BEARING BALL #6304	1	E/NO. 014501~118270
7	601B6205 	BEARING BALL #6205	1	E/NO. 118271~123772
8	601B6305 	BEARING BALL #6305	1	
9	92015-019 	NUT 18MM	1	E/NO. 118271~123772
10	92028-1037 	BUSHING,SECONDARY	1	E/NO. 118271~123772

FRONT



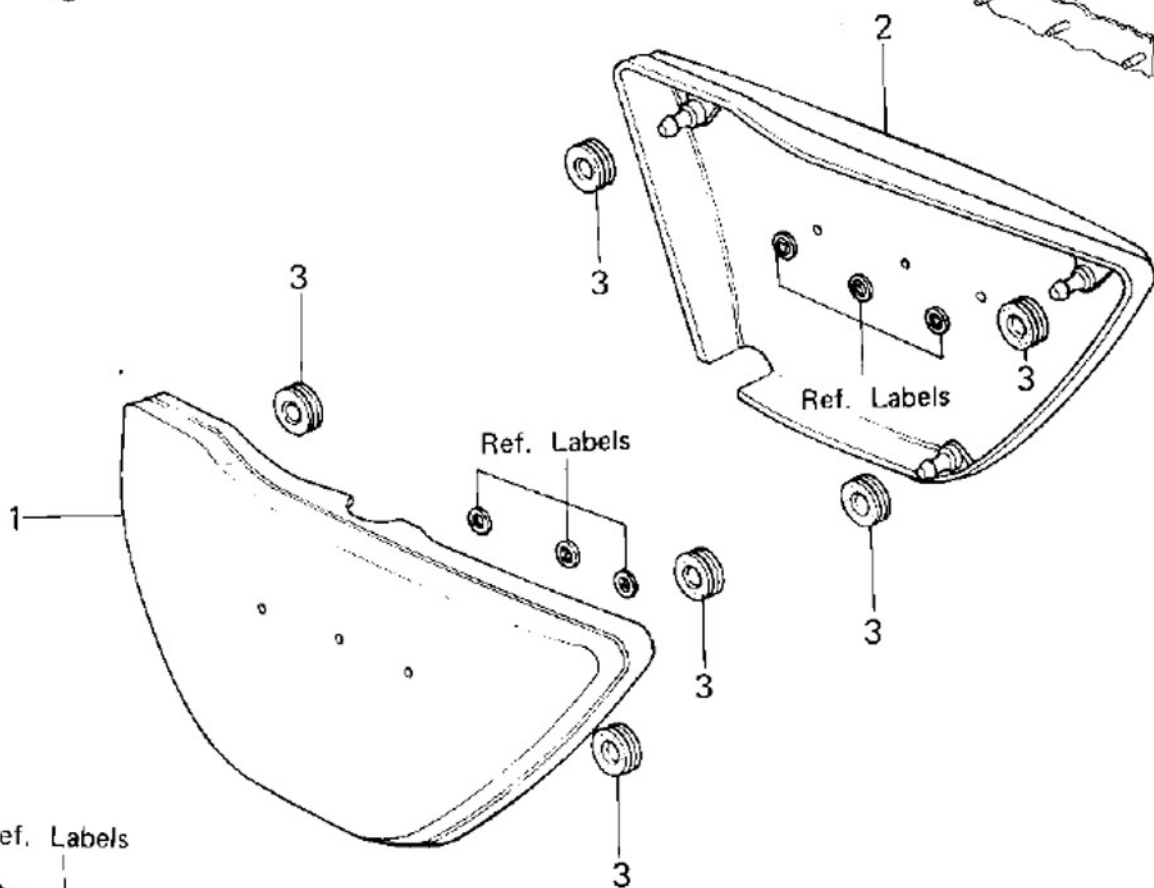



Ref. Labels

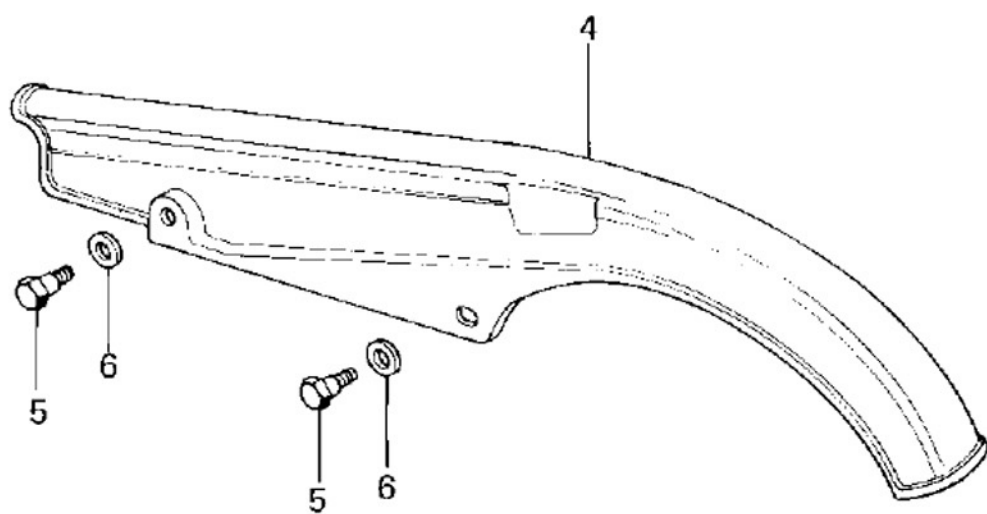

Ref. Labels

KZ650



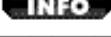





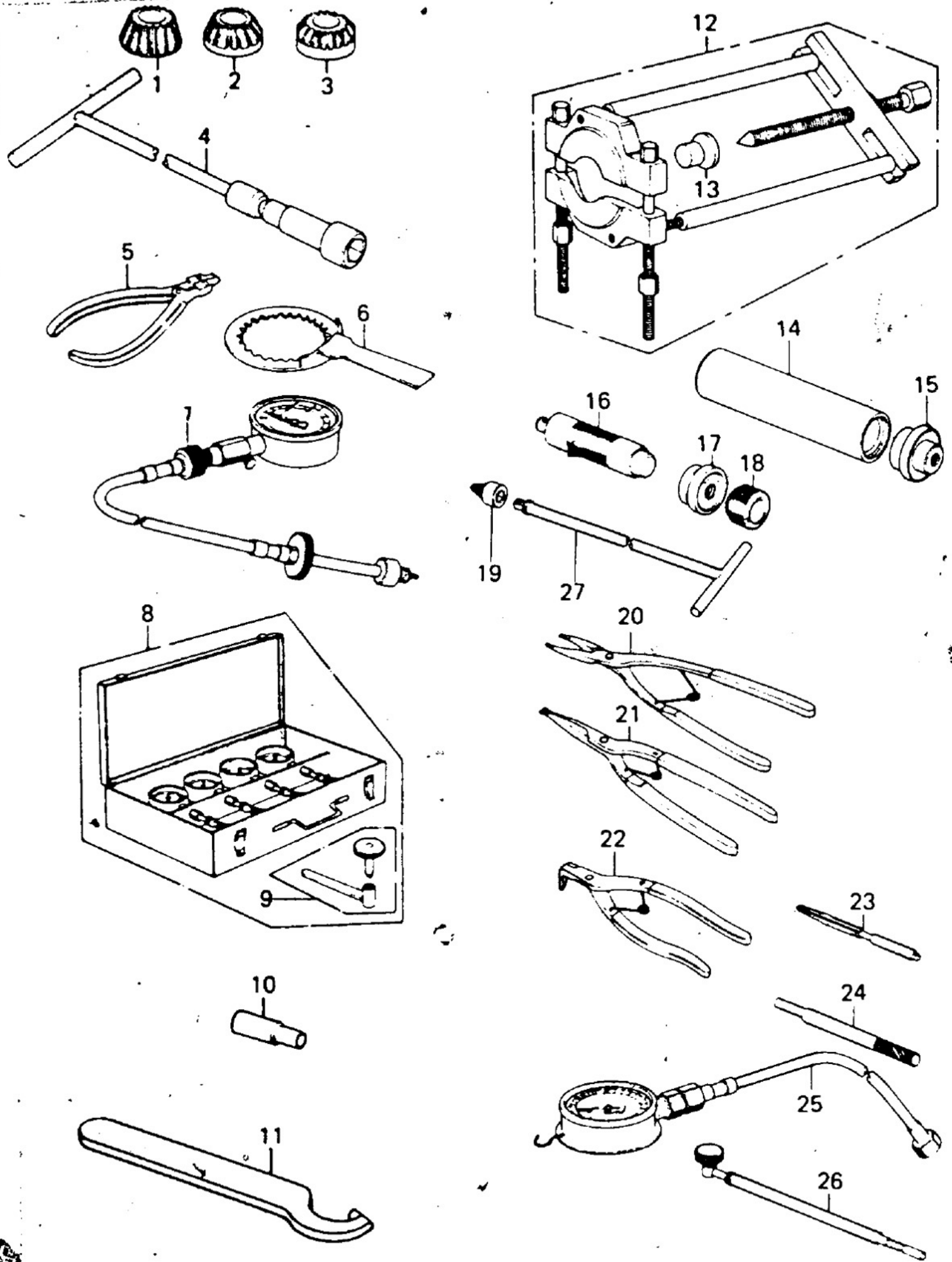



























Ref #	Part #	Description	Qty	Spec Code
1	36001-5012-7Z 	COVER,SIDE,L.H,D.BLUE	1	
1	36001-1034-4U 	COVER,SIDE,L.H,E.GREN	1	
2	36001-5013-7Z 	COVER,SIDE,R.H,D.BLUE	1	
2	36001-1035-4U 	COVER,SIDE,R.H,E.GREN	1	
3	92071-056 	GROMMET	6	
4	36014-068 	CASE-CHAIN	1	
5	92001-115 	BOLT,HEAX HEAD,6X14	2	
6	92022-1561 	WASHER,8.5X20X1.6	2	

80 KZ650-F1 Chassis

G-









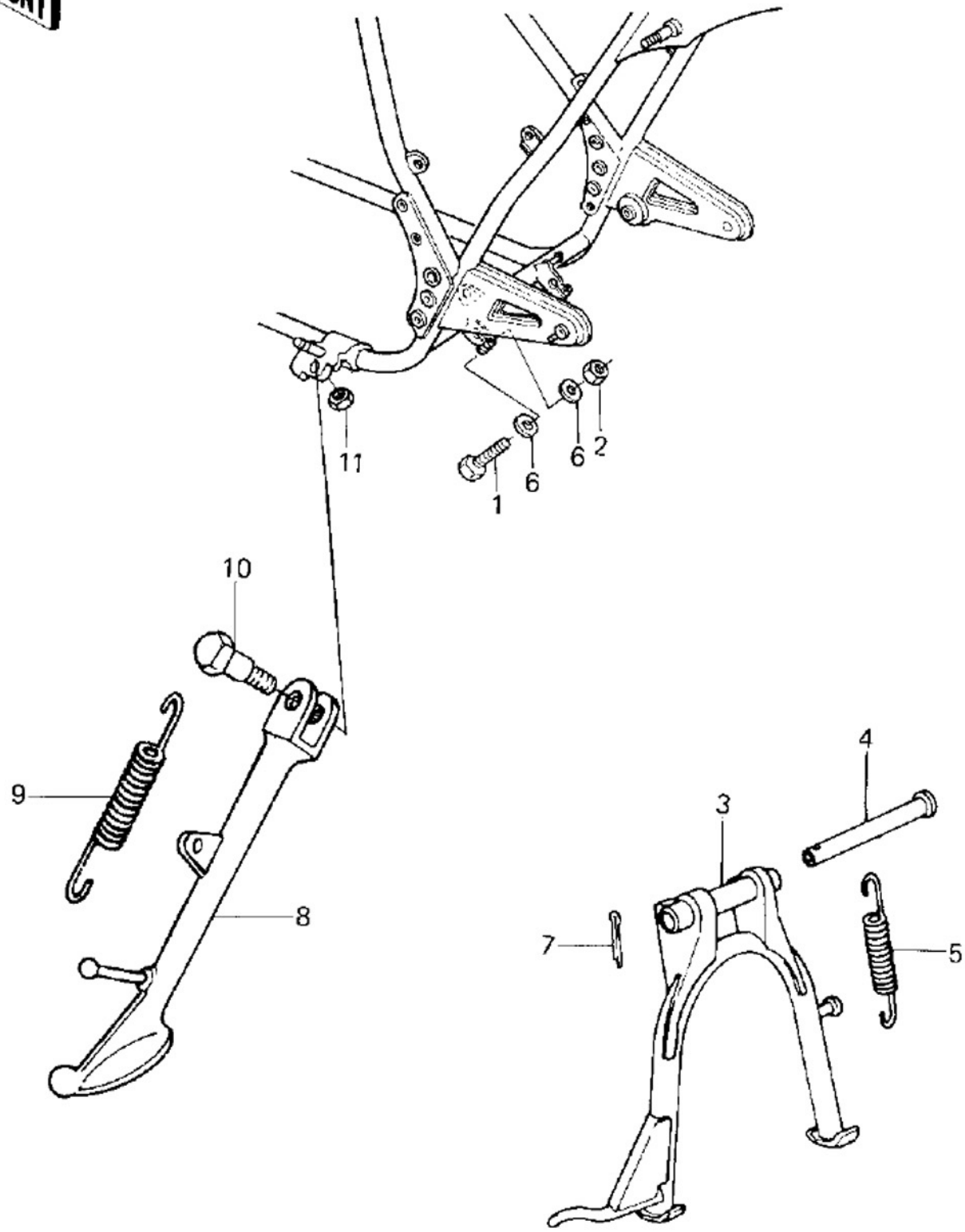



Ref #	Part #	Description	Qty	Spec Code
1	57001-101 	*** N.L.A.*** (Canada)	1	
2	57001-102 	*** N.L.A.*** (Canada)	1	
3	57001-104 	*** N.L.A.*** (Canada)	1	
4	57001-110 	WRENCH,SPARK PLUG (Canada)	1	
5	57001-115 	PLIERS-PISTON RING	1	
6	57001-119 	57001-1243 (Canada)	1	
7	57001-123 	*** N.L.A.*** (Canada)	1	
8	57001-127 	*** N.L.A.*** (Canada)	1	
9	57001-120 	ADJUSTER,THROTTLE VALV	1	
10	57001-132 	*** N.L.A.*** (Canada)	1	
11	57001-134 	57001-1100 (Canada)	1	
12	57001-135 	PULLER,STEM BEARING	1	
13	57001-136 	ADAPTER,STEM BEARING	1	
14	57001-137 	DRIVER,STEM BEARING	1	
15	57001-138 	57001-1129 (Canada)	1	
16	57001-139 	*** N.L.A.*** (Canada)	1	
17	57001-140 	57001-1129 (Canada)	1	
18	57001-141 	*** N.L.A.*** (Canada)	1	
19	57001-181 	57001-1011 (Canada)	1	
20	57001-143 	PLIERS,CIRCLIP,INSIDE	1	
21	57001-144 	PLIERS,CIRCLIP,OUTSID	1	
22	57001-154 	PLIERS,CIRCLIP	1	
23	57001-162 	REAMER,VALVE GUIDE	1	
24	57001-163 	ARBOR,VALVE GUIDE	1	
25	57001-164 	GAUGE,OIL PRESSURE	1	
26	57001-208 	GAUGE,FUEL LEVEL	1	
27	57001-183 	HANDLE,FORK CLY HOLDR	1	

Ref #	Part #	Description	Qty	Spec Code
1	57001-241 	COMPRESSOR,VLV SPRING	1	
2	57001-242 	57001-246 (Canada)	1	
3	57001-244 	BOLT,VALVE COMPRESER	1	
4	57001-254 	57001-1216 (Canada)	1	
5	57001-255 	HOLDER,DYNAMO ROTOR	1	
6	57001-265 	*** N.L.A.*** (Canada)	1	
7	57001-266 	GUIDE,SHFT SFT OIL SE	1	
8	57001-286 	57001-1129 (Canada)	1	
9	57001-290 	57001-1129 (Canada)	1	
10	57001-296 	*** N.L.A.*** (Canada)	1	
11	57001-297 	*** N.L.A.*** (Canada)	1	
12	57001-306 	57001-1343 (Canada)	1	
13	57001-309 	*** N.L.A.*** (Canada)	1	
14	57001-317 	ADAPTER,2ND GEAR PULR	1	
15	57001-351 	ADJUSTER BALANCE	1	
16	57001-380 	*** N.L.A.*** (Canada)	1	
17	57001-403 	57001-1278 (Canada)	1	
18	57001-531 	COMPRESSOR-PSTN RING	1	
19	57001-535 	PUSHER, SECONDARY GEAR	1	
20	57001-910 	PULLER-PISTON PIN	1	
21	57001-912 	ADAPTER A,PIN PULLER (Canada)	1	USE FOR KS125
22	57001-913 	ADAPTER B, PIN PULLER	1	USE FOR KS400
23	57001-914 	ADAPTER C,PIN PULLER	1	
24	57001-980 	*** N.L.A.*** (Canada)	1	
25	57001-983 	MULTIMETER	1	
26	57001-243 	ADAPTER,VLV COMPRESR	1	









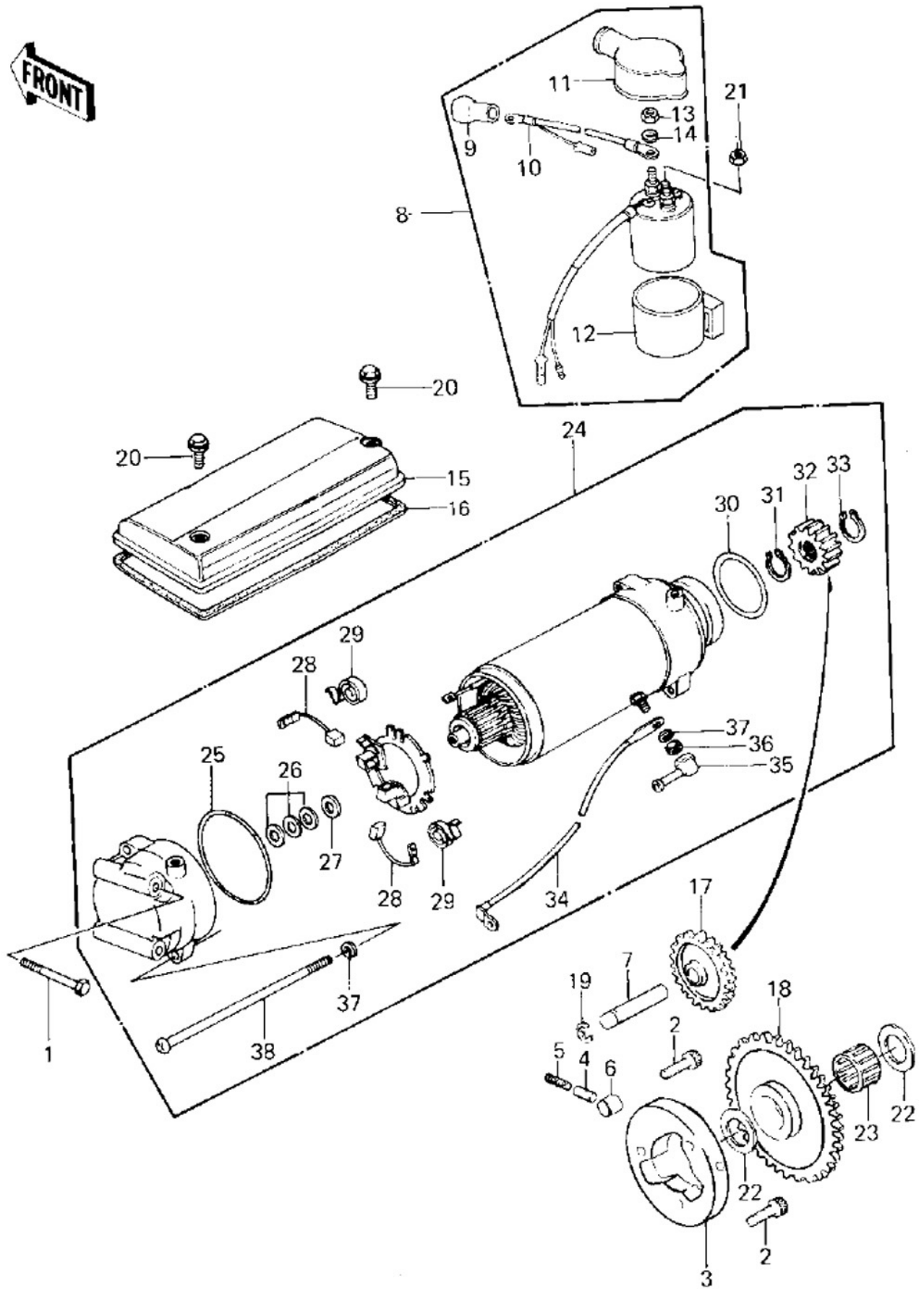







FRONT



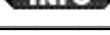
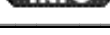
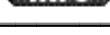
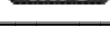
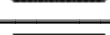
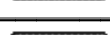







Ref #	Part #	Description	Qty	Spec Code
1	92001-1578 	BOLT	2	
2	311B0800 	NUT,8MM	2	
3	34011-1041 	STAND-MAIN	1	
4	34019-015 	SHAFT,MAIN STAND	1	
5	34023-016 	SPRING,MAIN STAND	1	
6	410B0800 	WASHER PLAIN 8MM	4	
7	550D3030 	PIN COTTER 3.0X30	1	
8	34024-1103 	STAND-SIDE	1	
9	34025-005 	SPRING,SIDE STAND	1	
10	92003-079 	BOLT-SIDE STAND	1	
11	92019-021 	NUT,LOCK,10MM	1	

FRONT





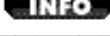



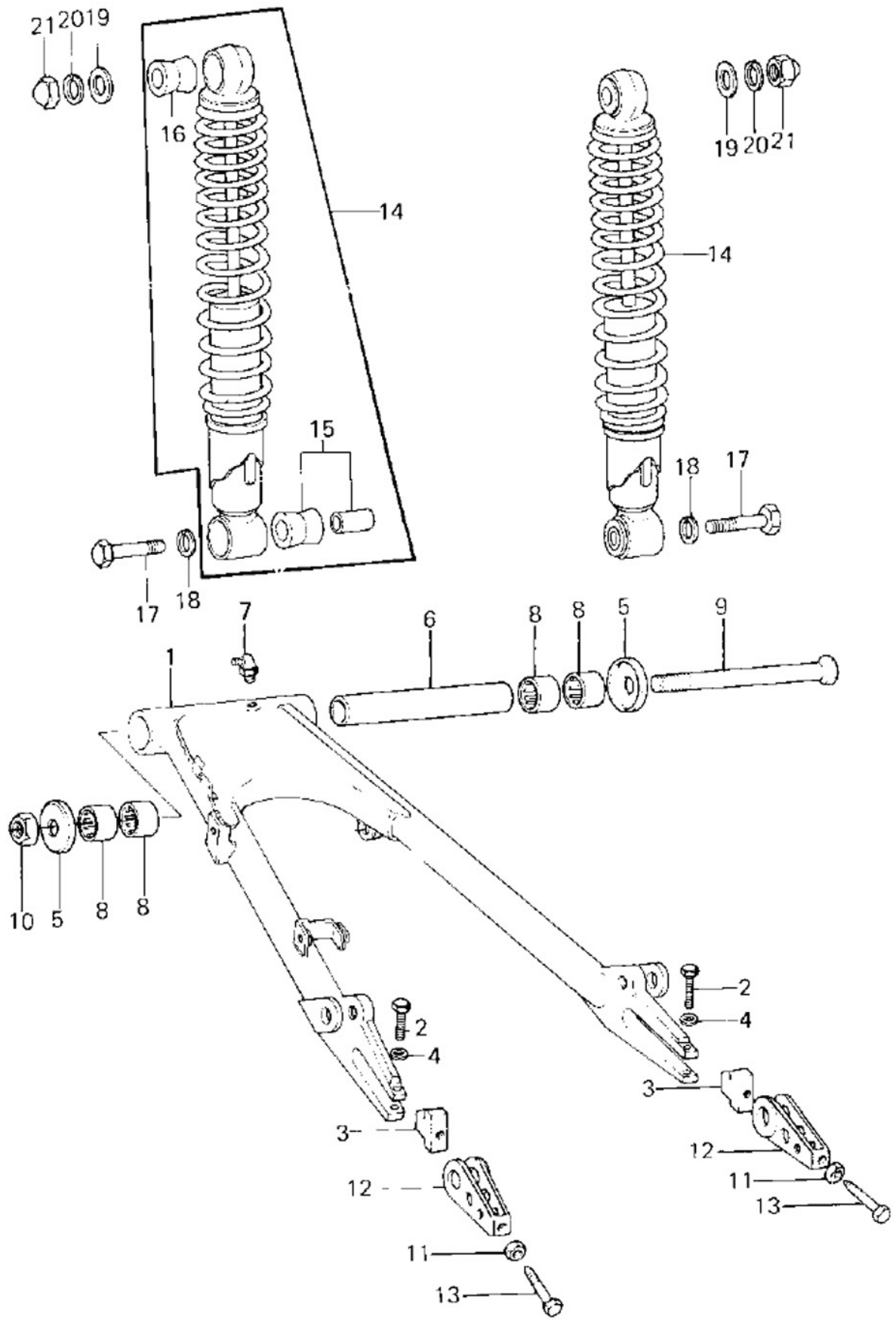











Ref #	Part #	Description	Qty	Spec Code
1	112G0660 	BOLT-UPSET	2	
2	120P0812 	BOLT,SOCKET,8X12	3	
3	13193-1012 	CLUTCH-ASSY-ONEWAY	1	
4	92043-087 	PIN	3	
5	92081-110 	SPRING	3	
6	92122-004 	ROLLER	3	
7	21143-003 	SHAFT,IDLE GEAR	1	
8	27010-1050 	SWITCH,MAGNETIC	1	
9	21017-023 	CAP,MAGNETIC SWITCH	1	
10	26011-1128 	WIRE-LEAD,MAGNETIC SW	1	
11	21141-004 	COVER MAGNETIC SWITCH	1	
12	21064-002 	DAMPER MAG SWITCH SHK	1	
13	312B0600 	NUT 6MM	1	
14	461F0600 	WASHER SPRING 6MM	1	
15	21165-003 	COVER,STARTER	1	
16	21166-003 	GASKET,STARTER COVER	1	
17	21167-004 	GEAR,IDLE,29T	1	
18	12046-1032 	SPROCKET,STARTER,58T	1	
19	482K0200 	CIRCLIP 12MM	1	
20	92001-1151 	BOLT,6X10	2	
21	92017-014 	NUT,LOCK 6MM	1	
22	92026-1025 	SPACER,25X36X3.2	2	
23	92046-056 	BRG,NEEDLE,K253017	1	
24	21163-1022 	STARTER-ELECTRIC	1	
25	21027-006 	"O" RING,62MM	1	
26	21025-011 	WASHER,THRUST,0.2T	AR	
27	21025-010 	WASHER,THRUST,1.6T	1	
28	21039-003 	CARBON BRUSH	2	
29	21040-003 	SPRING,CARBON BRUSH	2	









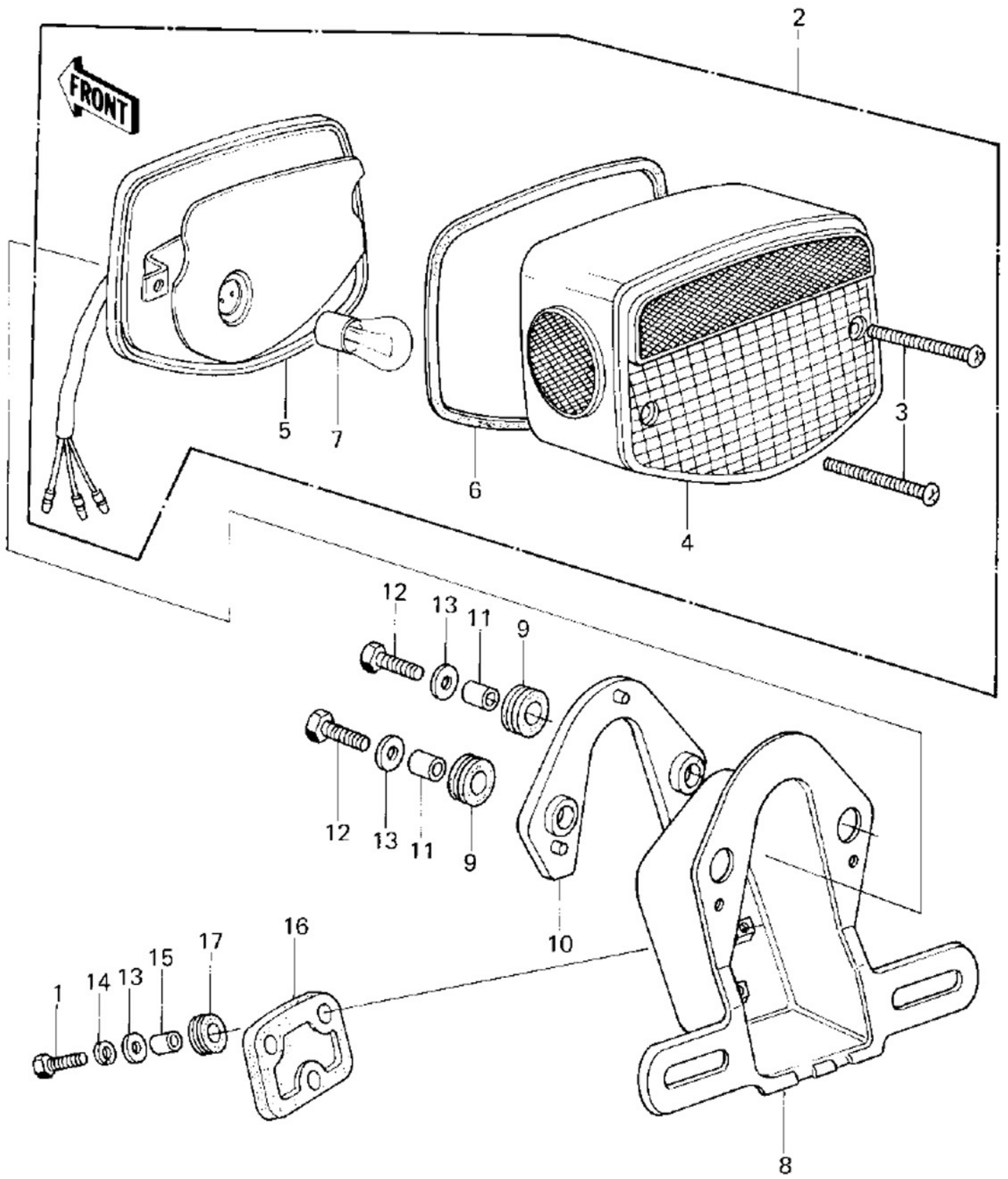



30	21027-008		"0" RING,40M/M	1	
31	92033-034		CIRCLIP	1	
32	21053-004		PINION,STARTER	1	
33	92033-037		CIRCLIP,13M/M	1	
34	26011-1099		WIRE-LEAD,STARTER	1	
35	21017 020		CAP, STARTER MOTOR TERMINAL	1	
36	312B0600		NUT 6MM	2	
37	461F0600		WASHER SPRING 6MM	4	
38	21099 006		SCREW, PAN HEAD, 6 X 130	2	

FRONT





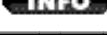
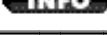
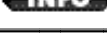
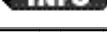
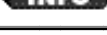
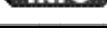





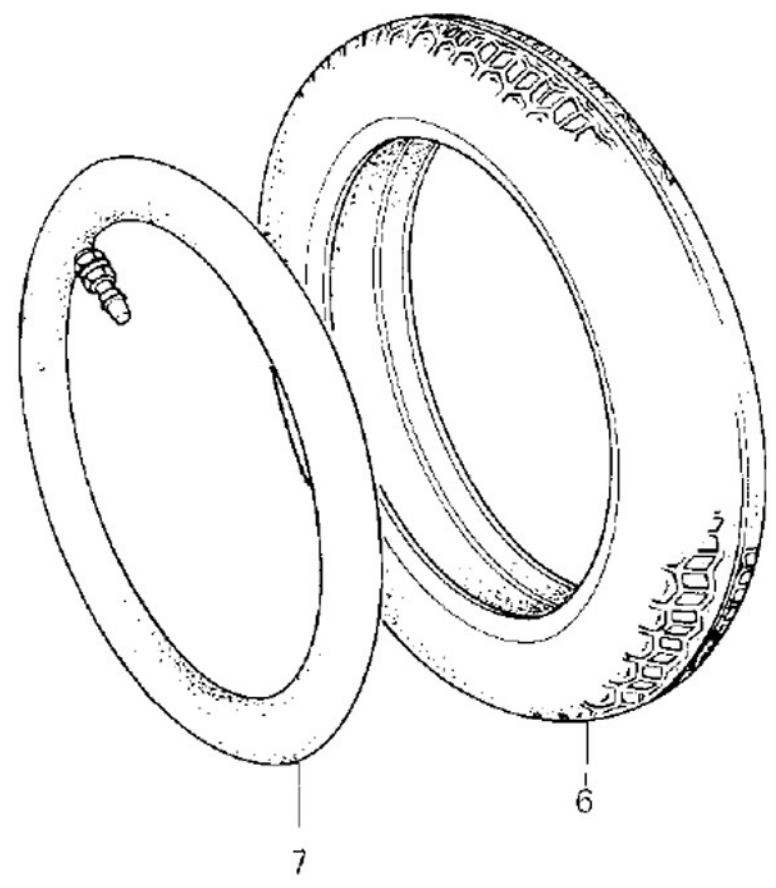
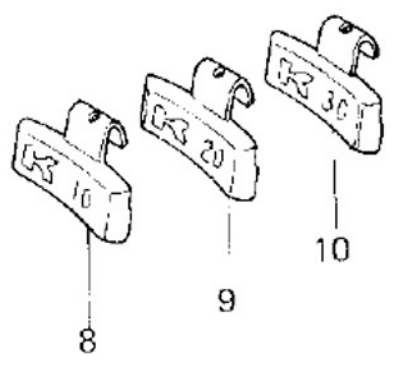
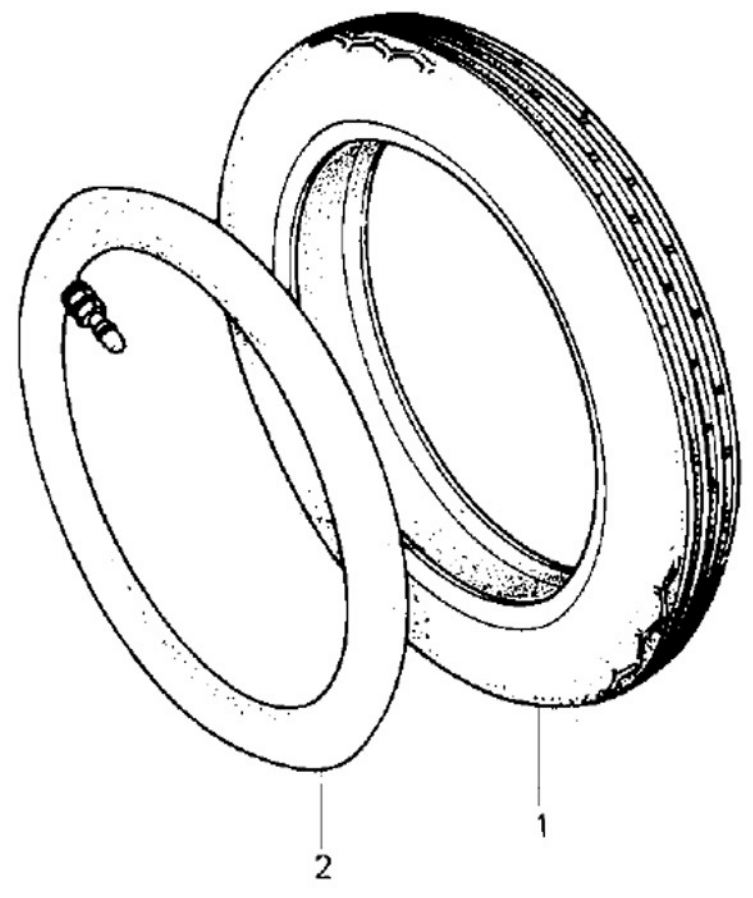
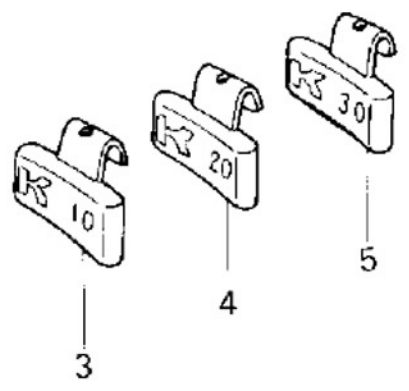

Ref #	Part #	Description	Qty	Spec Code
1	33001-1078 	ARM-COMP-SWING	1	
2	92001-1577 	BOLT,FLANGED,8X35	2	
3	33044-002 	STOPPER,CHAIN ADJUST	2	
4	461F0800 	WASHER SPRING 8MM	2	
5	33035-009 	CAP,SWING ARM	2	
6	42036-1012 	SLEEVE,SWING ARM	1	
7	92005-002 	GREASE NIPPLE	1	
8	92046-1115 	BEARING-NEEDLE,HK2216	4	
9	33032-050 	SHAFT,SWING ARM	1	
10	92019-012 	NUT-SELF LOCKING	1	
11	312B0800 	NUT 8MM	2	
12	33040-056 	ADJUSTER,CHAIN	2	
13	92001-1399 	BOLT,8X50	2	
14	45014-1044 	SHOCK ABSBR RR	2	
15	45017-019 	BUSHING,SHOCK ABSORBER	2	
16	45017-020 	BUSHING,SHOCK ABSORBER	2	
17	113N1035 	BOLT HEX HEAD 10X35	2	
18	461F1000 	WASHER SPRING 10MM	2	
19	410B1200 	WASHER PLAIN 12MM	2	
20	461F1200 	WASHER SPRING 12MM	2	
21	92020-014 	NUT 12MM	2	









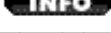

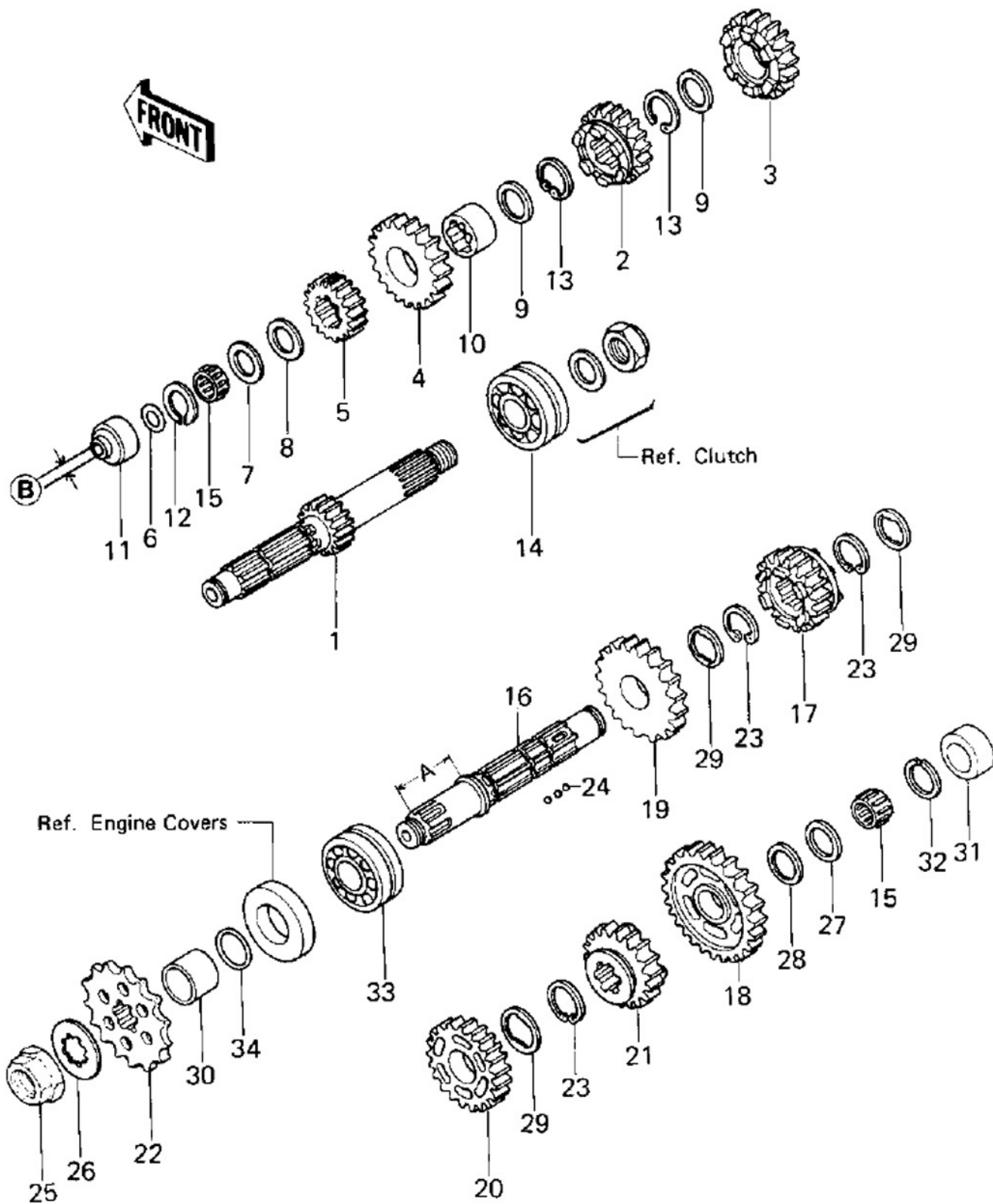





















Ref #	Part #	Description	Qty	Spec Code
1	112G0625 	BOLT-UPSET	3	
2	23025-064 	TAIL LAMP UNIT	1	
3	220R0460 	SCREW-PAN-CROS	2	
4	23026-034 	LENS,TAIL LAMP	2	
5	23027-041 	CASE,TAIL LIGHT	1	
6	23028-021 	GASKET,TAIL LENS	1	
7	92069-059 	BULB,12V 32/3CP	1	
8	23036-051 	BRACKET,LICENSE PLATE	1	
9	23066-020 	DAMPER RUBBER	2	
10	23066-023 	DAMPER RUBBER	1	
11	92027-129 	COLLAR,6.8X10X8.5	2	
12	112G0618 	BOLT-UPSET	2	
13	92022-125 	WASHER 6.5X20X1.6T	5	
14	461F0600 	WASHER SPRING 6MM	3	
15	92027-156 	COLLAR 6.8X10X14.5	3	
16	35039-004 	DAMPER RUBBER,RR FEND	1	
17	92075-121 	DAMPER RUBBER,RR FEND	3	









FRONT





Ref #	Part #	Description	Qty	Spec Code
1	41021-038 	TIRE 325H-19 F6B (F)	1	
2	41022-030 	*** N.L.A.*** (Canada)	1	
3	41075-1011 	BALANCER-WHEEL,10G	AR	
4	41075-1012 	BALANCER-WHEEL,20G	AR	
5	41075-1013 	BALANCER-WHEEL,30G	AR	
6	41021-039 	TIRE 400H-18 K87 (R)	1	
7	41022-031 	TUBE 350/375/410-18	1	
8	41075-1011 	BALANCER-WHEEL,10G	AR	
9	41075-1012 	BALANCER-WHEEL,20G	AR	
10	41075-1013 	BALANCER-WHEEL,30G	AR	

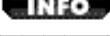
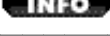
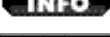
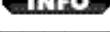

Ref #	Part #	Description	Qty	Spec Code
1	13127-051 	SHAFT,DRIVE	1	E/NO. 114501~118403
1	13127-1018 	SHAFT,DRIVE	1	E/NO. 118404~123772
2	13129-1032 	3RD GEAR,DRIVE SHAFT	1	
3	13129-1044 	4TH GEAR,DRIVE SHAFT	1	
4	13129-1045 	TOP GEAR,DRIVE SHAFT	1	
5	13130-041 	2ND GEAR,DRIVE	1	
6	670B1507 	"O" RING,7MM	1	E/NO. 114501~118403
6	670B1508 	"O" RING,8MM	1	E/NO. 118404~123772
7	92022-112 	WASHER THRUST	AR	
7	92022-144 	SHIM-KICK SHAFT	AR	
7	92022-1026 	WASHER,PLAIN	AR	
8	92022-113 	WASHER THRUST	1	
9	92022-161 	WASHER PLAIN	2	
10	92028-1007 	BUSHING,DRV SHFT TOP	1	
11	92028-179 	BUSHING,DRIVE SHAFT	1	E/NO. 114501~118403
11	92028-1032 	BUSHING,DRIVE SHAFT	1	E/NO. 118404~123772
12	92033-015 	CIRCLIP	1	
13	92033-026 	CIRCLIP	2	
14	92045-035 	BEARING,BALL	2	
15	92046-1030 	BEARING,VS20/14A	2	
16	13128-1012 	SHAFT,OUTPUT	1	
17	13129-1033 	TOP GEAR,OUTPUT SHAFT	1	
18	13129-1046 	LOW GEAR,OUTPUT SHAFT	1	
19	13129-1047 	2ND GEAR,OUTPUT SHAFT	1	
20	13129-1048 	3RD GEAR,OUTPUT SHAFT	1	
21	13129-1049 	4TH GEAR,OUTPUT SHAFT	1	
22	13144-063 	ENGINE SPROCKET,16T	1	
22	13144-1009 	ENGINE SPROCKET,17T	1	RACING USE ONLY
23	480J3000 	CIRCLIP,30MM	3	

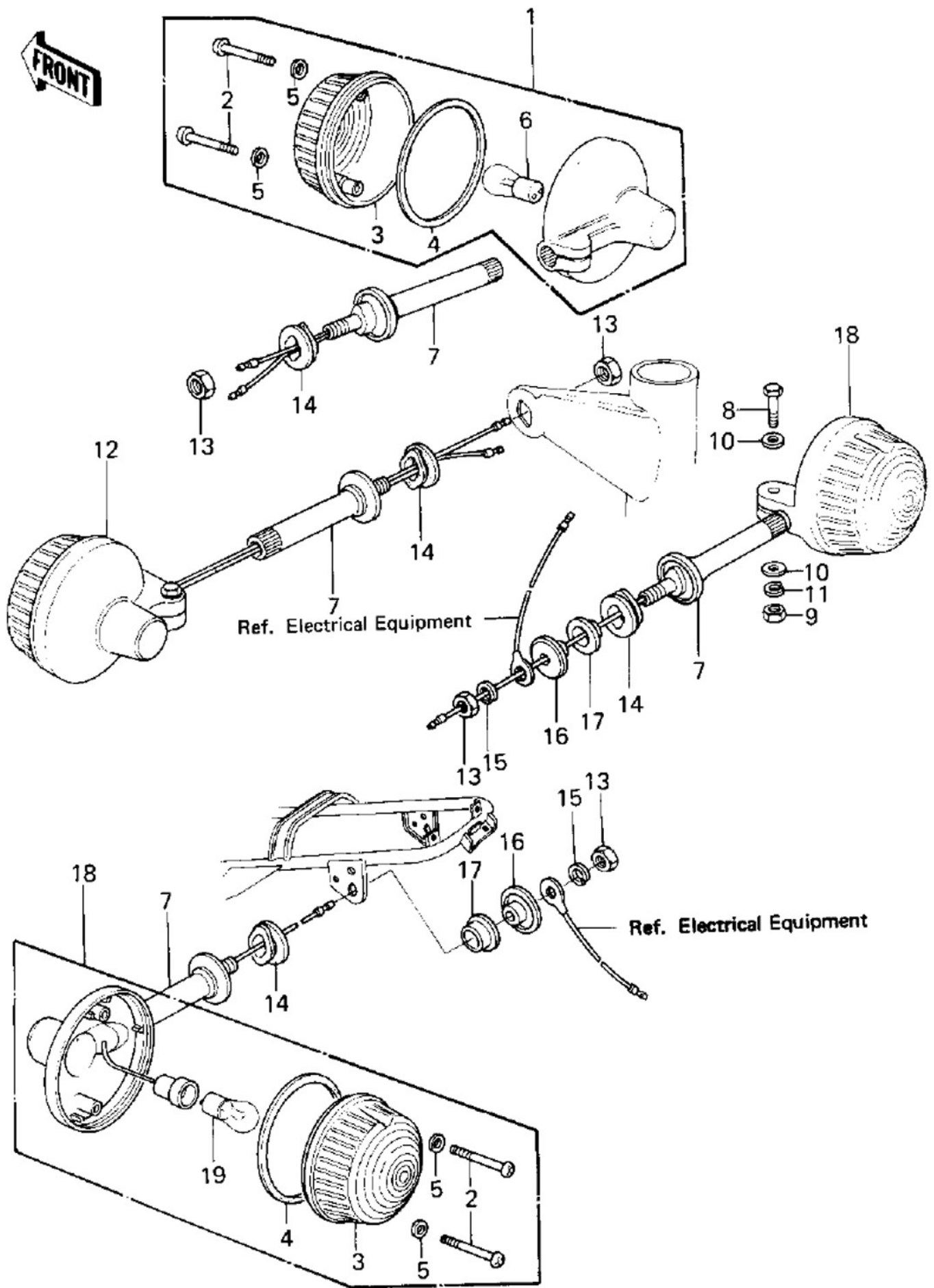
24	600A0500		BALL STEEL 5/32'	3	
25	92015-1254		NUT,20MM	1	
26	92200-1065		WASHER	1	
27	92022-112		WASHER THRUST	AR	
27	92022-144		SHIM-KICK SHAFT	AR	
28	92022-113		WASHER THRUST	1	
29	92024-069		WASHER,LOCK	3	
30	92027-288		COLLAR,ENG SPROCKET	1	
31	92028-180		BUSHING,OUTPUT SHAFT	1	
32	92033-015		CIRCLIP	1	
33	92045-035		BEARING,BALL	1	
34	92055-035		"O" RING	1	





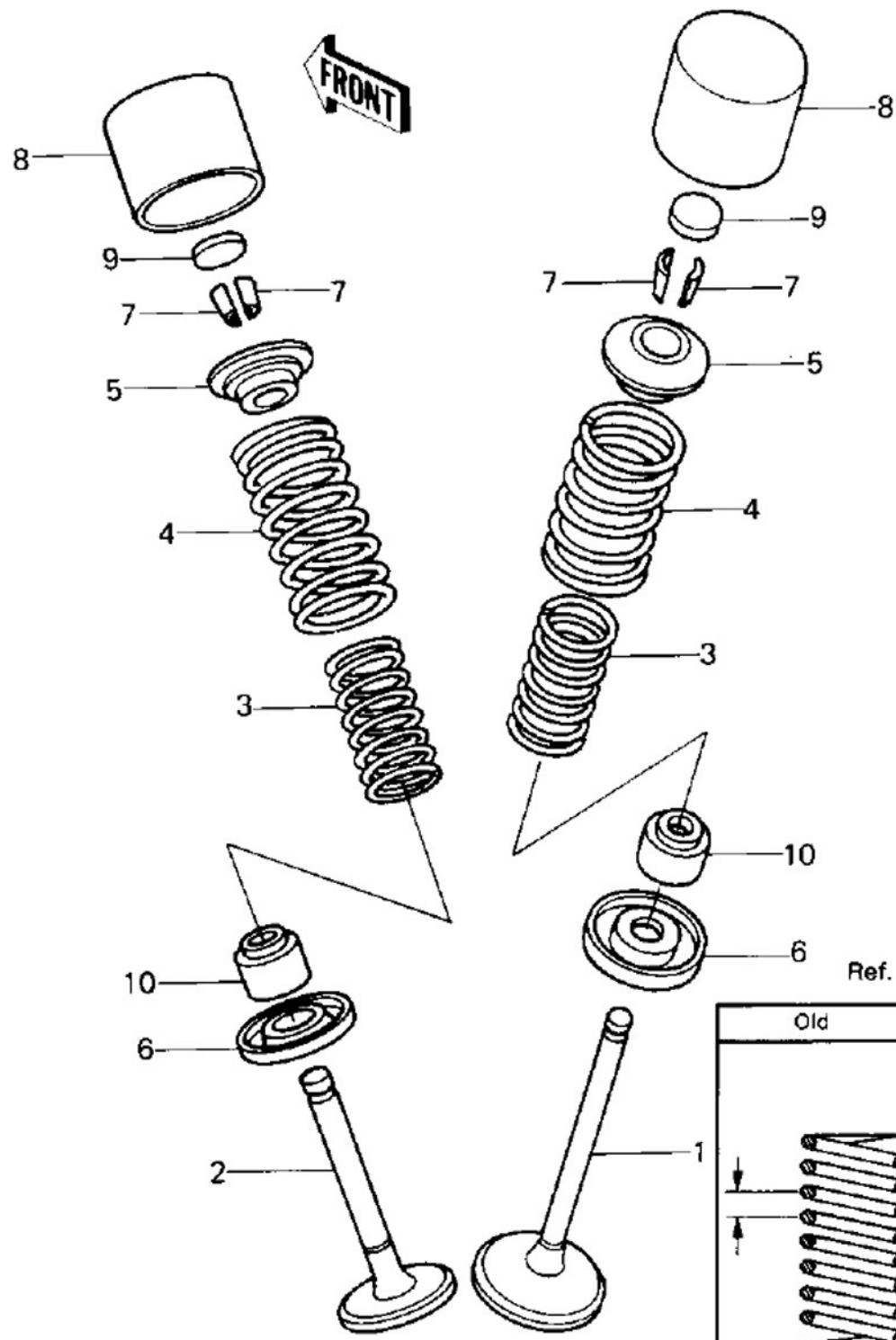



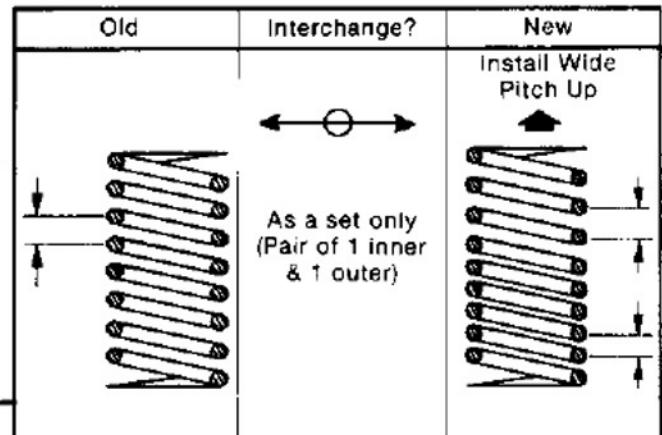





















Ref #	Part #	Description	Qty	Spec Code
1	23040-1005 	LIGHT ASSY,TRN SG,R.H	1	
2	220E0435A 	SCREW-PAN HEAD,4X35	8	
3	23048-1024 	LENS-SIGNAL LAMP	4	
4	23050-002 	GASKET,TURN SIG LAMP	4	
5	23058-002 	WASHER-PLAIN,4MM	8	
6	92069-060 	BULB,12V 23/8W	2	
7	23051-053 	BRACKET,TURN SIGNAL.L	4	
8	112G0630 	BOLT-UPSET	4	
9	311B0600 	NUT 6MM	4	
10	411B0600 	WASHER PLAIN 6MM	8	
11	461F0600 	WASHER SPRING 6MM	4	
12	23040-1006 	LIGHT ASSY,TRN,SG,L.H	1	
13	315B1000 	NUT 10MM	4	
14	92075-128 	DAMPER RUBBER	4	
15	461F1000 	WASHER SPRING 10MM	2	
16	92027-147 	COLLAR	2	
17	92075-158 	DAMPER RUBBER,SIG LM	2	
18	23040-029 	LAMP-TURN SIGNAL	2	
19	92069-055 	BULB 12V 32CP	2	



Ref. Nos. 3 & 4, Valve Springs



Identification	Old	New
Inner	12007-011	49078-1001
Outer	12007-012	49078-1002
Remarks	Constant Pitch	Dual Pitch
E/No.	114501~118190	118191~123772

Ref #	Part #	Description	Qty	Spec Code
1	12004-1011 	VALVE,INTAKE	4	
2	12005-008 	VALVE,EXHAUST	4	
3	12007-011 	SPRING,INNER VALVE	8	E/NO. 114501~118190
3	49078-1001 	SPRING,VALVE,INNER	8	E/NO. 118191~123772
4	12007-012 	SPRING,OUTER VALVE	8	E/NO. 114501~118190
4	49078-1002 	SPRING,VALVE,OUTER	8	E/NO. 118191~123772
5	12009-008 	RETAINER,VALVE SPRING	8	
6	16007-1024 	SEAT-SPRING,VALVE	8	
7	12011-004 	SPLIT KEEPER	16	
8	12032-1001 	TAPPET	8	
9	92025-1090 	SHIM,2.007	AR	
9	92025-1091 	SHIM,2.05T	AR	
9	92025-1092 	SHIM,2.10T	AR	
9	92025-1093 	SHIM,2.15T	AR	
9	92025-1094 	SHIM,2.20T	AR	
9	92025-1095 	SHIM,2.25T	AR	
9	92025-1096 	SHIM,2.30T	AR	
9	92025-1097 	SHIM,2.35T	AR	
9	92025-1098 	SHIM,2.40T	AR	
9	92025-1099 	SHIM,2.45T	AR	
9	92025-1100 	SHIM,2.50T	AR	
9	92025-1101 	SHIM T2.55	AR	
9	92025-1102 	SHIM,2.60T	AR	
9	92025-1103 	SHIM,2.65T	AR	
9	92025-1104 	SHIM,2.70T	AR	
9	92025-1105 	SHIM,2.75T	AR	
9	92025-1106 	SHIM,2.80T	AR	
9	92025-1107 	SHIM,2.85T	AR	
9	92025-1108 	SHIM,2.90T	AR	

9	92025-1109	INFO	SHIM,2.95	AR	
9	92025-1110	INFO	SHIM,3.00T	AR	
9	92025-1111	INFO	SHIM,3.05T	AR	
9	92025-1112	INFO	SHIM,3.10T	AR	
9	92025-1113	INFO	SHIM,3.15T	AR	
9	92025-1114	INFO	SHIM,3.20T	AR	
10	92049-016	INFO	OIL SEAL,RV37129.5	8	