



YASKAWA

YASKAWA AC Drive J1000

Compact V/f Control Drive

Installation & Start-Up Manual

Type: CIMR-JA , CIMR-JT

Models: 200 V Class, Three-Phase Input: 0.1 to 5.5 kW
200 V Class, Single-Phase Input: 0.1 to 2.2 kW
400 V Class, Three-Phase Input: 0.2 to 5.5 kW

To properly use the product, read this manual thoroughly and retain for easy reference, inspection, and maintenance. Ensure the end user receives this manual.

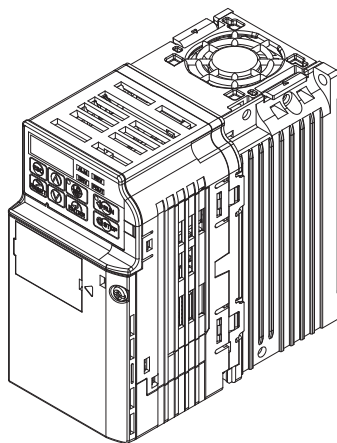

Receiving

1

Mechanical Installation

2

Electrical Installation

3

Start-Up Programming & Operation

4

Troubleshooting

5

Periodic Inspection & Maintenance

6

Peripheral Devices & Options

7

Specifications

A

Parameter List

B

Standards Compliance

C

This Page Intentionally Blank

Copyright © 2008 YASKAWA ELECTRIC CORPORATION. All rights reserved.

All rights reserved. No part of this publication may be reproduced, stored in a retrieval system, or transmitted, in any form or by any means, mechanical, electronic, photocopying, recording, or otherwise, without the prior written permission of Yaskawa. No patent liability is assumed with respect to the use of the information contained herein. Moreover, because Yaskawa is constantly striving to improve its high-quality products, the information contained in this manual is subject to change without notice. Every precaution has been taken in the preparation of this manual. Yaskawa assumes no responsibility for errors or omissions. Neither is any liability assumed for damages resulting from the use of the information contained in this publication.



Table of Contents

i.	PREFACE & GENERAL SAFETY	9
i.1	Preface	10
	Applicable Documentation	10
	Symbols.....	10
	Terms and Abbreviations.....	11
i.2	General Safety	12
	Supplemental Safety Information.....	12
	Safety Messages	13
	Drive Label Warnings	15
	Warranty Information	16
	Quick Reference.....	18
1.	RECEIVING	19
1.1	Section Safety.....	20
1.2	Model Number and Nameplate Check.....	21
	Nameplate.....	21
1.3	Drive Models.....	24
1.4	Component Names	25
	IP20/Open-Chassis	25
	Front Views	27

2.	MECHANICAL INSTALLATION	29
2.1	Section Safety.....	30
2.2	Mechanical Installation	33
	Installation Environment	33
	Installation Orientation and Spacing.....	34
	Removing and Attaching the Protective Covers	35
	Exterior and Mounting Dimensions	35
3.	ELECTRICAL INSTALLATION	39
3.1	Section Safety.....	40
3.2	Standard Connection Diagram.....	43
3.3	Main Circuit Connection Diagram	46
	Single-Phase 200 V Class (CIMR-J□BA0001 ~ 0010).....	46
	Three-Phase 200 V Class (CIMR-J□2A0001 ~ 0020);	
	Three-Phase 400 V Class (CIMR-J□4A0001 ~ 0011)	46
3.4	Terminal Block Configuration	47
3.5	Protective Covers	48
	IP20/Open-Chassis Cover Removal and Installation.....	48
3.6	Main Circuit Wiring	50
	Main Circuit Terminal Functions.....	50
	Wire Gauges and Tightening Torque.....	50
	Main Circuit Terminal Power Supply and Motor Wiring.....	52
3.7	Control Circuit Wiring	54
	Control Circuit Terminal Block Functions.....	55
	Terminal Configuration.....	56
	Wiring Procedure	57
3.8	I/O Connections	60
	Sinking/Sourcing Mode Switch.....	60
3.9	Main Frequency Reference	63
	DIP Switch S1 Analog Input Signal Selection.....	63
3.10	Braking Resistor.....	65
	Installation.....	65
3.11	Interlocking with Connected Machinery	67

Drive Ready Signal	67
4. START-UP PROGRAMMING & OPERATION	69
4.1 Section Safety.....	70
4.2 Using the Digital LED Operator.....	73
Keys, Displays, and LEDs.....	73
Digital Text Display	74
LED Screen Displays.....	75
LO/RE LED and RUN LED Indications	75
Menu Structure for Digital LED Operator.....	77
4.3 The Drive and Programming Modes	78
Navigating the Drive and Programming Modes.....	78
Changing Parameter Settings or Values	82
Verifying Parameter Changes: Verify Menu	83
Switching Between LOCAL and REMOTE.....	84
Parameters Available in the Setup Group.....	85
4.4 Start-up Flowcharts	86
Flowchart: Basic Start-up and Motor Tuning	86
4.5 Basic Operation	87
Initialize Parameter Values: A1-03.....	87
Frequency Reference Source: b1-01.....	87
Run Command Input Selection: b1-02.....	89
Stopping Method Selection: b1-03.....	91
Acceleration/Deceleration: C1-01 to C1-04.....	92
Drive Duty Mode and Carrier Frequency Selection: C6-01 and C6-02.....	93
Multi-Step Speed Operation (4-Step Speed).....	96
Drive Input Voltage Setting: E1-01.....	99
V/f Pattern Settings: E1-04 to E1-10	100
Motor Parameters: E2-01 to E2-03	103
Digital Output: H2-01	103
Analog Outputs: H4-01 to H4-03	104
Motor Protection: L1-01 and L1-02	105
Notes on Controlling the Brake for the Hoist Application.....	108
Drive Status Monitors: U1-01 to U4-13	109
4.6 Powering Up the Drive.....	111
Powering Up the Drive and Operation Status Display	111

V/f Pattern Setting.....	111
4.7 No-Load Operation Test Run	113
No-Load Operation Test Run.....	113
4.8 Test Run with Load Connected.....	115
Test Run with the Load Connected.....	115
4.9 Verifying and Backing Up Parameter Settings.....	116
Parameter Access Level: A1-01.....	116
Password Settings: A1-04, A1-05.....	116
5. TROUBLESHOOTING	117
5.1 Section Safety.....	118
5.2 Motor Performance Fine Tuning	121
Parameters for Tuning the Drive	121
Motor Hunting and Oscillation Control Parameters	121
5.3 Drive Alarms, Faults, and Errors.....	123
Types of Alarms, Faults, and Errors.....	123
Alarm and Error Displays.....	124
5.4 Fault Detection	126
Fault Displays, Causes, and Possible Solutions	126
5.5 Alarm Detection	134
Alarm Codes, Causes, and Possible Solutions.....	134
5.6 Operator Programming Errors.....	139
oPE Codes, Causes, and Possible Solutions	139
5.7 Diagnosing and Resetting Faults.....	141
Fault Occurs Simultaneously with Power Loss	141
If the Drive Still has Power After a Fault Occurs	141
Viewing Fault Trace Data After Fault.....	141
Fault Reset Methods	142
5.8 Troubleshooting without Fault Display.....	143
Cannot Change Parameter Settings.....	143
Motor Does Not Rotate Properly after Pressing RUN Button or after Entering External Run Command.....	143
6. PERIODIC INSPECTION & MAINTENANCE	151

6.1	Section Safety	152
6.2	Inspection	155
	Recommended Daily Inspection.....	155
	Recommended Periodic Inspection.....	156
6.3	Periodic Maintenance	159
	Replacement Parts.....	159
6.4	Drive Cooling Fans	161
	Cooling Fan Replacement	161
7.	PERIPHERAL DEVICES & OPTIONS	165
7.1	Section Safety	166
7.2	Peripheral Devices	168
7.3	Connecting Peripheral Devices	170
7.4	Installing Peripheral Devices	171
	Installing a Molded Case Circuit Breaker (MCCB).....	171
	Installing a Leakage Breaker	172
	Installing a Magnetic Contactor	172
	Connecting an AC or DC Reactor.....	173
	Connecting a Surge Absorber.....	174
	Connecting a Noise Filter	174
	Zero-Phase Reactor	177
	Installing Fuses on the Input Side.....	178
	Installing a Motor Thermal Overload (oL) Relay on the Drive Output.....	178
	NEMA Type 1 Kit.....	180
7.5	Communication Options	185
A.	SPECIFICATIONS	187
A.1	Heavy Duty and Normal Duty Ratings	188
A.2	Single/Three-Phase 200 V Class Drive	189
A.3	Three-Phase 400 V Class Drives	190
A.4	Drive Specifications	191
A.5	Drive Watt Loss Data	194
A.6	Drive Derating Data	195
	Temperature Derating.....	195

B.	PARAMETER LIST	197
B.1	Parameter Groups	198
B.2	Parameter Table.....	199
A:	Initialization Parameters	199
b:	Application	199
C:	Tuning	201
d:	References	203
E:	Motor Parameters	204
H	Parameters: Multi-Function Terminals	206
L:	Protection Function	210
n:	Advanced Performance Set-Up	214
o:	Operator Related Parameters	214
U:	Monitors	216
B.3	Defaults Determined by Drive Capacity (o2-04) and ND/ HD (C6-01)	219
B.4	Defaults Determined by Carrier Frequency Selection (C6-02)	222
B.5	Defaults Determined by Carrier Frequency Reduction (L8-38).....	223
C.	STANDARDS COMPLIANCE	225
C.1	Section Safety.....	226
C.2	European Standards	229
CE	Low Voltage Directive Compliance	229
EMC	Guidelines Compliance.....	230
C.3	UL Standards	236
UL	Standards Compliance	236
Drive	Motor Overload Protection	238



Preface & General Safety

This section provides safety messages pertinent to this product that, if not heeded, may result in fatality, personal injury, or equipment damage. Yaskawa is not responsible for the consequences of ignoring these instructions.

I.1	PREFACE.....	10
I.2	GENERAL SAFETY.....	12

i.1 Preface

Yaskawa manufactures products used as components in a wide variety of industrial systems and equipment. The selection and application of Yaskawa products remain the responsibility of the equipment manufacturer or end user. Yaskawa accepts no responsibility for the way its products are incorporated into the final system design. Under no circumstances should any Yaskawa product be incorporated into any product or design as the exclusive or sole safety control. Without exception, all controls should be designed to detect faults dynamically and fail safely under all circumstances. All systems or equipment designed to incorporate a product manufactured by Yaskawa must be supplied to the end user with appropriate warnings and instructions as to the safe use and operation of that part. Any warnings provided by Yaskawa must be promptly provided to the end user. Yaskawa offers an express warranty only as to the quality of its products in conforming to standards and specifications published in the Yaskawa manual. **NO OTHER WARRANTY, EXPRESSED OR IMPLIED, IS OFFERED.** Yaskawa assumes no liability for any personal injury, property damage, losses, or claims arising from misapplication of its products.

This manual is designed to ensure correct and suitable application of Variable J1000-Series Inverters. Read this manual before attempting to install, operate, maintain, or inspect an Inverter and keep it in a safe, convenient location for future reference. Be sure you understand all precautions and safety information before attempting application.

◆ Applicable Documentation

The following manuals are available for J1000 series drives:

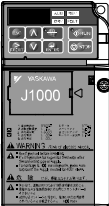
	J1000 Series Compact V/f Control Drive Installation and Start-Up Manual
	Read this manual first. This guide is packaged together with the product. It contains basic information required to install and wire the drive. This guide provides basic programming and simple setup and adjustment. Refer to the J1000 Technical Manual for complete descriptions of drive features and functions.
	J1000 Series Compact V/f Control Drive Technical Manual
	This manual describes installation, wiring, operation procedures, functions, troubleshooting, maintenance, and inspections to perform before operation.

◆ Symbols

Note: Indicates a supplement or precaution that does not cause drive damage.



Indicates a term or definition used in this manual.

◆ Terms and Abbreviations

- **Drive:** Yaskawa J1000 Series Drive

i.2 General Safety

◆ Supplemental Safety Information

General Precautions

- The diagrams in this manual may be indicated without covers or safety shields to show details. Restore covers or shields before operating the drive and run the drive according to the instructions described in this manual.
- Any illustrations, photographs, or examples used in this manual are provided as examples only and may not apply to all products to which this manual is applicable.
- The products and specifications described in this manual or the content and presentation of the manual may be changed without notice to improve the product and/or the manual.
- When ordering a new copy of the manual due to damage or loss, contact your Yaskawa representative or the nearest Yaskawa sales office and provide the manual number shown on the front cover.
- If nameplate becomes worn or damaged, order a replacement from your Yaskawa representative or the nearest Yaskawa sales office.

WARNING

Read and understand this manual before installing, operating or servicing this drive. The drive must be installed according to this manual and local codes.

The following conventions are used to indicate safety messages in this manual. Failure to heed these messages could result in serious or possibly even fatal injury or damage to the products or to related equipment and systems.

DANGER

Indicates a hazardous situation, which, if not avoided, will result in death or serious injury.

WARNING

Indicates a hazardous situation, which, if not avoided, could result in death or serious injury.

WARNING! *will also be indicated by a bold key word embedded in the text followed by an italicized safety message.*

 **CAUTION**

Indicates a hazardous situation, which, if not avoided, could result in minor or moderate injury.

CAUTION! will also be indicated by a bold key word embedded in the text followed by an italicized safety message.

NOTICE

Indicates a property damage message.

NOTICE: will also be indicated by a bold key word embedded in the text followed by an italicized safety message.

◆ **Safety Messages**

 **DANGER**

Heed the safety messages in this manual.

Failure to comply will result in death or serious injury.

The operating company is responsible for any injuries or equipment damage resulting from failure to heed the warnings in this manual.

Electrical Shock Hazard

Do not connect or disconnect wiring while the power is on.

Failure to comply will result in death or serious injury.

Before servicing, disconnect all power to the equipment. The internal capacitor remains charged even after the power supply is turned off. The charge indicator LED will extinguish when the DC bus voltage is below 50 Vdc. To prevent electric shock, wait at least one minute after all indicators are OFF and measure the DC bus voltage level to confirm safe level.

WARNING

Sudden Movement Hazard

System may start unexpectedly upon application of power, resulting in death or serious injury.

Clear all personnel from the drive, motor and machine area before applying power. Secure covers, couplings, shaft keys and machine loads before applying power to the drive.

Electrical Shock Hazard

Do not attempt to modify or alter the drive in any way not explained in this manual.

Failure to comply could result in death or serious injury.

Yaskawa is not responsible for any modification of the product made by the user. This product must not be modified.

Do not allow unqualified personnel to use equipment.

Failure to comply could result in death or serious injury.

Maintenance, inspection, and replacement of parts must be performed only by authorized personnel familiar with installation, adjustment and maintenance of AC drives.

Do not remove covers or touch circuit boards while the power is on.

Failure to comply could result in death or serious injury.

Fire Hazard

Do not use an improper voltage source.

Failure to comply could result in death or serious injury by fire.

Verify that the rated voltage of the drive matches the voltage of the incoming power supply before applying power.

CAUTION

Crush Hazard

Do not carry the drive by the front cover.

Failure to comply may result in minor or moderate injury from the main body of the drive falling.

NOTICE

Observe proper electrostatic discharge procedures (ESD) when handling the drive and circuit boards.

Failure to comply may result in ESD damage to the drive circuitry.

Never connect or disconnect the motor from the drive while the drive is outputting voltage.

Improper equipment sequencing could result in damage to the drive.

Do not perform a withstand voltage test on any part of the drive.

Failure to comply could result in damage to the sensitive devices within the drive.

Do not operate damaged equipment.

Failure to comply could result in further damage to the equipment.

Do not connect or operate any equipment with visible damage or missing parts.

Install adequate branch circuit short circuit protection per applicable codes.

Failure to comply could result in damage to the drive.

The drive is suitable for circuits capable of delivering not more than 30,000 RMS symmetrical Amperes, 240 Vac maximum (200 V Class) and 480 Vac maximum (400 V Class).

Do not expose the drive to halogen group disinfectants.

Failure to comply may cause damage to the electrical components in the drive.

Do not pack the drive in wooden materials that have been fumigated or sterilized.

Do not sterilize the entire package after the product is packed.

◆ Drive Label Warnings

Always heed the warning information listed in *Figure i.1* in the position shown in *Figure i.2*.

WARNING Risk of electric shock.



-  Read manual before installing.
- Wait 1 minute for capacitor discharge after disconnecting power supply.
- To conform to  requirements, make sure to ground the supply neutral for 400V class.

Figure i.1 Warning Information

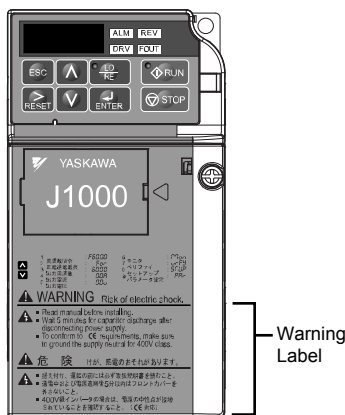

Figure i.2 Warning Information Position

◆ Warranty Information

■ Warranty Period

This drive is warranted for 12 months from the date of delivery to the customer or 18 months from the date of shipment from the Yaskawa factory, whichever comes first.

■ Scope of Warranty

Inspections

Customers are responsible for periodic inspections of the drive. Upon request, a Yaskawa representative will inspect the drive for a fee. If the Yaskawa representative finds the drive to be defective due to Yaskawa workmanship or materials and the defect occurs during the warranty period, this inspection fee will be waived and the problem remedied free of charge.

Repairs

If a Yaskawa product is found to be defective due to Yaskawa workmanship or materials and the defect occurs during the warranty period, Yaskawa will provide a replacement, repair the defective product, and provide shipping to and from the site free of charge.

However, if the Yaskawa Authorized Service Center determines that the problem with the drive is not due to defective workmanship or materials, the customer will be responsible for the cost of any necessary repairs. Some problems that are outside the scope of this warranty are:

Problems due to improper maintenance or handling, carelessness, or other reasons where the customer is determined to be responsible.

Problems due to additions or modifications made to a Yaskawa product without Yaskawa's understanding.

Problems due to the use of a Yaskawa product under conditions that do not meet the recommended specifications.

Problems caused by natural disaster or fire.

After the free warranty period elapses.

Replenishment or replacement of consumables or expendables.

Defective products due to packaging or fumigation.

Other problems not due to defects in Yaskawa workmanship or materials.

Warranty service is only applicable within Japan. However, after-sales service is available for customers outside of Japan for a reasonable fee.

Contact your local Yaskawa representative for more information.

Exceptions

Any inconvenience to the customer or damage to non-Yaskawa products due to Yaskawa's defective products whether within or outside of the warranty period are NOT covered by warranty.

■ Restrictions

The J1000 was not designed or manufactured for use in devices or systems that may directly affect or threaten human lives or health.

i.2 General Safety

Customers who intend to use the product described in this manual for devices or systems relating to transportation, health care, space aviation, atomic power, electric power, or in underwater applications must first contact their Yaskawa representatives or the nearest Yaskawa sales office.

This product has been manufactured under strict quality-control guidelines. However, if this product is to be installed in any location where failure of this product could involve or result in a life-and-death situation or loss of human life or in a facility where failure may cause a serious accident or physical injury, safety devices must be installed to minimize the likelihood of any accident.

◆ Quick Reference

Run a Motor of One-Frame Larger Capacity

When using this drive for variable torque loads such as fans and pumps, a motor one frame size larger can be used.

Know the Details of Safety Measures

The functions listed below affect the safe operation of the drive. Ensure that the settings fit the application requirements prior to operation.

Safe operations. Run by power on. Parameter setting b1-17.

LOCAL/REMOTE key effective during stop in drive mode. Parameter o2-01.

LED operator stop key priority selection. Parameter o2-02.

Enter press required after changing the keypad frequency reference. Parameter o2-05.

Operation interlock when program mode is selected. Parameter b1-08.

Check the Maintenance Period Using Drive Monitors

The maintenance period of fans and capacitors can be checked with drive monitors.

Drive or Motor Faults are Displayed on a Digital Operator

Refer to Fault Displays, Causes, and Possible Solutions on page 126 and Refer to Alarm Codes, Causes, and Possible Solutions on page 134.

Standards Compliance

Refer to European Standards on page 229 and Refer to UL Standards on page 236.





Receiving

This chapter describes the proper inspections to perform after receiving the drive and illustrates the different enclosure types and components.

1.1	SECTION SAFETY.....	20
1.2	MODEL NUMBER AND NAMEPLATE CHECK	21
1.3	DRIVE MODELS.....	24
1.4	COMPONENT NAMES.....	25

1.1 Section Safety

CAUTION

Do not carry the drive by the front cover.

Failure to comply may cause the main body of the drive to fall, resulting in minor or moderate injury.

NOTICE

Observe proper electrostatic discharge procedures (ESD) when handling the drive and circuit boards.

Failure to comply may result in ESD damage to the drive circuitry.

A motor connected to a PWM drive may operate at a higher temperature than a utility-fed motor and the operating speed range may reduce motor cooling capacity.

Ensure that the motor is suitable for inverter duty and/or the motor service factor is adequate to accommodate the additional heating with the intended operating conditions.

1.2 Model Number and Nameplate Check

Please perform the following tasks after receiving the drive:

- Inspect the drive for damage.
If the drive appears damaged upon receipt, contact the shipper immediately.
- Verify receipt of the correct model by checking the information on the nameplate.
- If you have received the wrong model or the drive does not function properly, contact your supplier.

◆ Nameplate

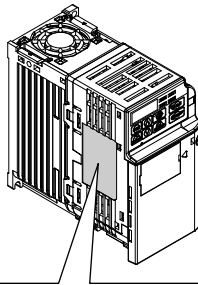

Drive model	MODEL : CIMR-JA2A0004BAA	cULus LISTED	IND. CONT. EQ. 7J48 B
Input specifications	MAX APPLI. MOTOR : 0.75kW / 0.4kW REV : A		
Output specifications	INPUT : AC3PH 200-240V 50 / 60Hz 2.7A / 1.4A	PRG : 1010	Software version
Lot number	OUTPUT : AC3PH 0-240V 0-400Hz 1.2A / 0.8A		
Serial number	MASS : 0.9 kg	CE	
	O / N : _____		
	S / N : _____	PASS	
	FILE NO : E131457 IP20		
	 YASKAWA ELECTRIC CORPORATION MADE IN JAPAN RoHS		

Figure 1.1 Nameplate Information

1.2 Model Number and Nameplate Check

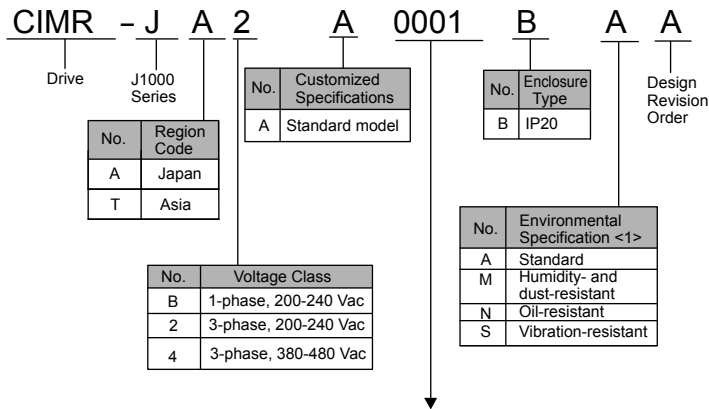

■ Single-Phase 200 V

Normal Duty		
No.	Max. Motor Capacity kW	Rated Output Current A
0001	0.2	1.2
0002	0.4	1.9
0003	0.75	3.3
0006	1.1	6
0010	2.2	9.6

Heavy Duty		
No.	Max. Motor Capacity kW	Rated Output Current A
0001	0.1	0.8
0002	0.2	1.6
0003	0.4	3
0006	0.75	5
0010	1.5	8

■ Three-Phase 200 V

Normal Duty		
No.	Max Motor Capacity kW	Rated Output Current A
0001	0.2	1.2
0002	0.4	1.9
0004	0.75	3.5
0006	1.1	6
0008	1.5	8.0
0010	2.2	9.6
0012	3.0	12
0018	3.7	17.5
0020	5.5	19.6

Heavy Duty		
No.	Max Motor Capacity kW	Rated Output Current A
0001	0.1	0.8
0002	0.2	1.6
0004	0.4	3
0006	0.75	5
0008	1.1	6.9
0010	1.5	8
0012	2.2	11
0018	3.0	14.0
0020	3.7	17.5

■ Three-Phase 400 V

Normal Duty		
No.	Max. Motor Capacity kW	Rated Output Current A
0001	0.4	1.2
0002	0.75	2.1
0004	1.5	4.1
0005	2.2	5.4
0007	3.0	6.9
0009	3.7	8.8
0011	5.5	11.1

Heavy Duty		
No.	Max. Motor Capacity kW	Rated Output Current A
0001	0.2	1.2
0002	0.4	1.8
0004	0.75	3.4
0005	1.5	4.8
0007	2.2	5.5
0009	3.0	7.2
0011	3.7	9.2

<1> Drives with these specifications do not guarantee complete protection for the specified environmental condition.

1.3 Drive Models

The following table describes drive models.

Table 1.1 Drive Models

Voltage Class	IP20/Open-Chassis CIMR-J□
Single-Phase 200 V Class	BA0001B
	BA0002B
	BA0003B
	BA0006B
	BA0010B
Three-Phase 200 V Class	2A0001B
	2A0002B
	2A0004B
	2A0006B
	2A0008B
	2A0010B
	2A0012B
	2A0018B
	2A0020B
Three-Phase 400 V Class	4A0001B
	4A0002B
	4A0004B
	4A0005B
	4A0007B
	4A0009B
4A0011B	

1.4 Component Names

This section illustrates the drive components as they are mentioned in this manual.

◆ IP20/Open-Chassis

- Single-Phase AC200 V CIMR-J□BA0001B ~ 0003B
- Three-Phase AC200 V CIMR-J□2A0001B ~ 0006B

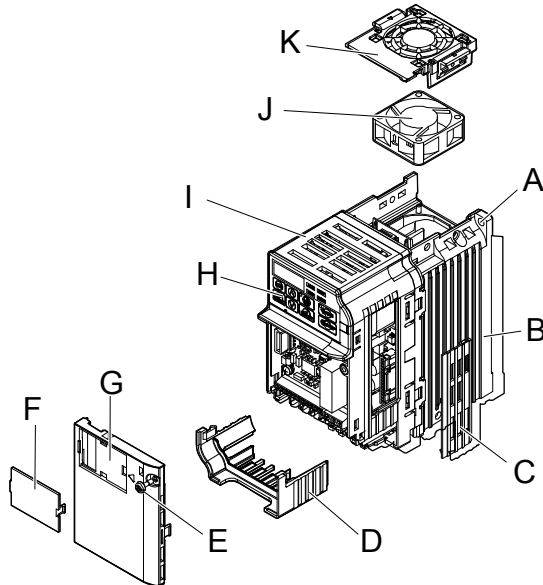

- | | |
|----------------------------|--|
| A – Mounting hole | G – Front cover |
| B – Heatsink | H – LED operator <i>Refer to Using the Digital LED Operator on page 73</i> |
| C – Cable cover | I – Case |
| D – Terminal cover | J – Cooling fan <1> |
| E – Front cover screw | K – Fan cover <1> |
| F – Option connector cover | |

Figure 1.2 Exploded View of IP20/Open-Chassis Type Components
Three-Phase AC200 V CIMR-J□2A0006B

- <1> The drives CIMR-J□BA0001B ~ 0003B and CIMR-J□2A0001B ~ 0004B do not have a cooling fan or a cooling fan cover.

1.4 Component Names

- Single-Phase AC200 V CIMR-J□BA0006B ~ 0010B
- Three-Phase AC200 V CIMR-J□2A0008B ~ 0020B
- Three-Phase AC400 V CIMR-J□4A0001B ~ 0011B

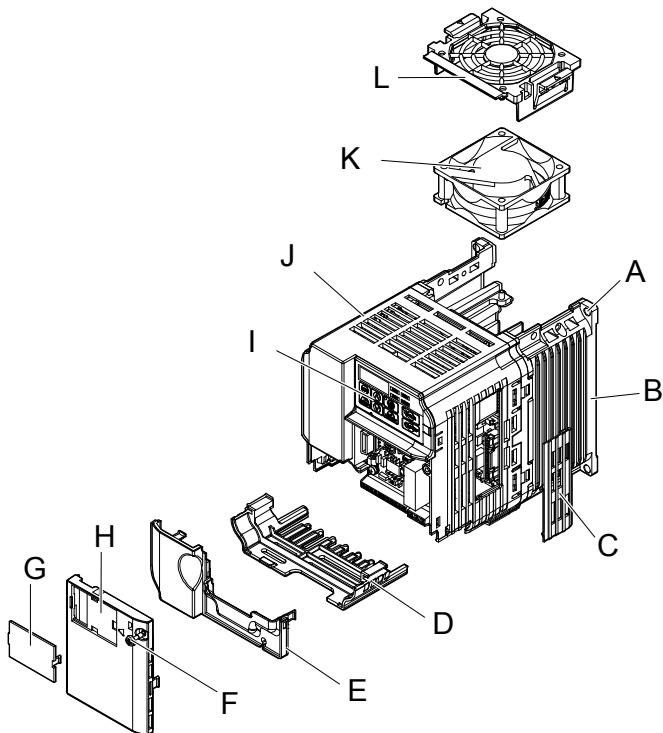

- A – Mounting hole
- B – Heatsink
- C – Cable cover
- D – Terminal cover
- E – Bottom cover
- F – Front cover screw
- G – Option connector cover
- H – Front cover
- I – LED operator *Refer to Using the Digital LED Operator on page 73*
- J – Case
- K – Cooling fan <1>
- L – Fan cover <1>

Figure 1.3 Exploded view of IP20/Open-Chassis Type Components
Three-Phase AC200 V CIMR-J□2A0012B

- <1> The drives CIMR-J□BA0006B and CIMR-J□4A0001B ~ 0004B do not have a cooling fan or a cooling fan cover.

◆ Front Views

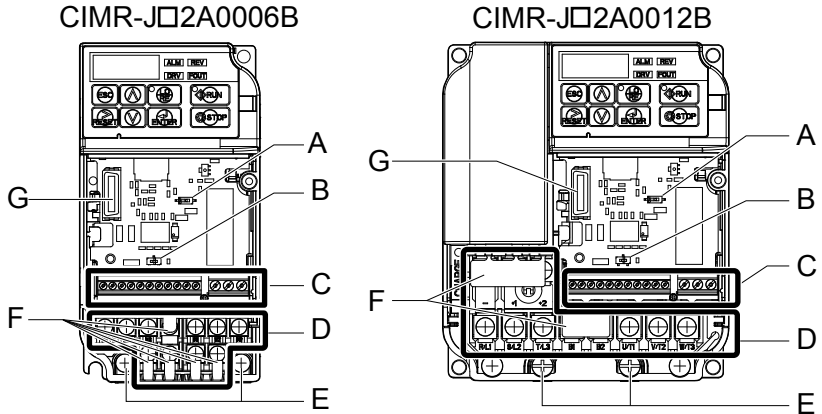

- A – DIP switch S1 *Refer to DIP Switch S1 Analog Input Signal Selection on page 63*
- B – DIP switch S3 *Refer to Sinking/Sourcing Mode Switch on page 60*
- C – Control circuit terminal *Refer to Control Circuit Wiring on page 54*
- D – Main circuit terminal *Refer to Wiring the Main Circuit Terminal on page 53*
- E – Ground terminal
- F – Terminal cover
- G – Option unit connector

Figure 1.4 Front Views of Drives

This Page Intentionally Blank



Mechanical Installation

This chapter explains how to properly mount and install the drive.

2.1	SECTION SAFETY.....	30
2.2	MECHANICAL INSTALLATION.....	33

2.1 Section Safety

WARNING

Fire Hazard

Provide sufficient cooling when installing the drive inside an enclosed panel or cabinet.

Failure to comply could result in overheating and fire.

When multiple drives are placed inside the same enclosure panel, install proper cooling to ensure air entering the enclosure does not exceed 40 °C.

CAUTION

Crush Hazard

Do not carry the drive by the front cover.

Failure to comply may result in minor or moderate injury from the main body of the drive falling.

NOTICE

Observe proper electrostatic discharge (ESD) procedures when handling the drive.

Failure to comply could result in ESD damage to the drive circuitry.

It may be difficult to perform maintenance on the cooling fans of drives installed in a vertical row inside an enclosure.

Ensure adequate spacing at the top of the drive to perform cooling fan replacement when required.

Operating the motor in the low-speed range diminishes the cooling effects, increases motor temperature, and may lead to motor damage by overheating.

Reduce the motor torque in the low-speed range whenever using a standard blower cooled motor. If 100% torque is required continuously at low speed, consider using a special drive or vector motor. Select a motor that is compatible with the required load torque and operating speed range.

Do not operate motors above the maximum rated RPM.

Failure to comply may lead to bearing or other mechanical motor failures.

The speed range for continuous operation differs according to the lubrication method and motor manufacturer.

If the motor is to be operated at a speed higher than the rated speed, consult with the manufacturer.

Continuously operating an oil-lubricated motor in the low-speed range may result in burning.

NOTICE

When the input voltage is 440 V or higher or the wiring distance is greater than 100 meters, pay special attention to the motor insulation voltage or use a drive-rated motor.

Failure to comply could lead to motor winding failure.

Motor vibration may increase when operating a machine in variable-speed mode, if that machine previously operated at a constant speed.

Install vibration-proof rubber on the motor base or use the frequency jump function to skip a frequency resonating the machine.

The motor may require more acceleration torque with drive operation than with a commercial power supply.

Set a proper V/f pattern by checking the load torque characteristics of the machine to be used with the motor.

The rated input current of submersible motors is higher than the rated input current of standard motors.

Select an appropriate drive according to its rated output current. When the distance between the motor and drive is long, use a cable thick enough to connect the motor to the drive to prevent motor torque reduction.

When using an explosion-proof motor, it must be subject to an explosion-proof test in conjunction with the drive.

This is also applicable when an existing explosion-proof motor is to be operated with the drive. Since the drive itself is not explosion-proof, always install it in a safe place.

Do not use a drive for a single-phase motor.

Replace the motor with a three-phase motor.

If an oil-lubricated gearbox or speed reducer is used in the power transmission mechanism, oil lubrication will be affected when the motor operates only in the low speed range.

The power transmission mechanism will make noise and experience problems with service life and durability if the motor is operated at a speed higher than the rated speed.

2.2 Mechanical Installation

This section outlines specifications, procedures, and environment for proper mechanical installation of the drive.

◆ Installation Environment

To help prolong the optimum performance life of the drive, install the drive in the proper environment. The table below provides a description of the appropriate environment for the drive.

Table 2.1 Installation Environment

Environment	Conditions
Installation Area	Indoors
Ambient Temperature	-10 °C to +50 °C (IP20/Open-Chassis) Drive reliability improves in environments without wide temperature fluctuations. When using an enclosure panel, install a cooling fan or air conditioner in the area to ensure that the air temperature inside the enclosure does not exceed the specified levels. Do not allow ice to develop on the drive.
Humidity	95% RH or less and free of condensation
Storage Temperature	-20 °C to +60 °C
Surrounding Area	Install the drive in an area free from: <ul style="list-style-type: none"> • oil mist and dust • metal shavings, oil, water or other foreign materials • radioactive materials • combustible materials (e.g., wood) • harmful gases and liquids • excessive vibration • chlorides • direct sunlight
Altitude	1000 m or lower
Vibration	10 to 20 Hz at 9.8 m/s ² 20 to 55 Hz at 5.9 m/s ²
Orientation	Install the drive vertically to maintain maximum cooling effects.

NOTICE: Prevent foreign matter such as metal shavings or wire clippings from falling into the drive during installation and project construction. Failure to comply could result in damage to the drive. Place a temporary cover over the top of the drive during installation. Remove the temporary cover before startup, as the cover will reduce ventilation and cause the drive to overheat.

2.2 Mechanical Installation

◆ Installation Orientation and Spacing

Install the drive upright as illustrated in [Figure 2.1](#) to maintain proper cooling.

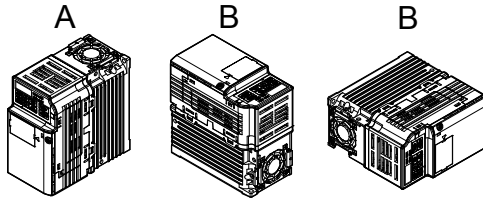

A – Correct

B – Incorrect

Figure 2.1 Correct Installation Orientation

■ Single Drive Installation

[Figure 2.2](#) explains the required installation spacing to maintain sufficient space for airflow and wiring. Install the heatsink against a closed surface to avoid diverting cooling air around the heatsink.

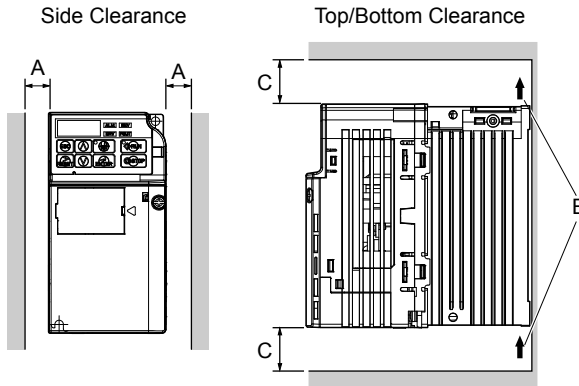

A – 30 mm minimum

B – Airflow direction

C – 100 mm minimum

Figure 2.2 Correct Installation Spacing

Multiple Drive Installation

When installing multiple drives into the same enclosure panel, mount the drives according to [Figure 2.2](#). When mounting drives with a minimum side-by-side clearance of 2 mm according to [Figure 2.3](#), derating must be considered and parameter L8-35 must be set. [Refer to Parameter List on page 197](#).

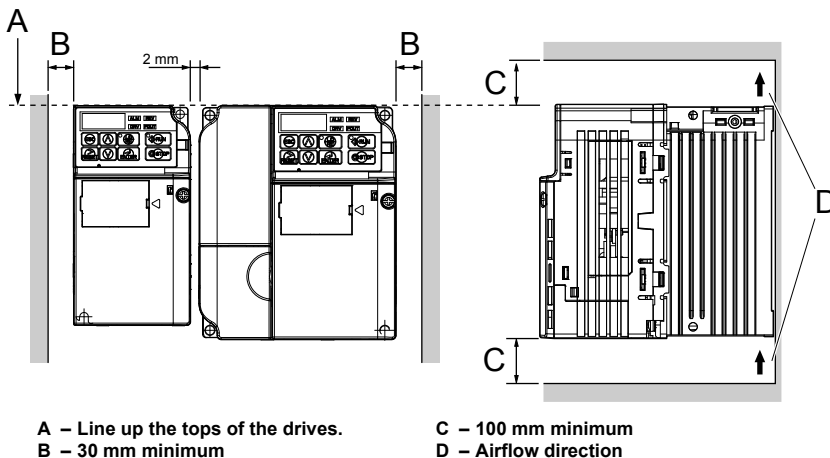

Figure 2.3 Space Between Drives (Side-by-Side Mounting)

Note: When installing drives of different sizes into the same enclosure panel, the tops of the drives should line up. Leave space between the top and bottom of stacked drives for cooling fan replacement if required. Using this method, it is possible to replace the cooling fans later.

Removing and Attaching the Protective Covers

[Refer to Electrical Installation on page 39](#), for information regarding the removal and reattachment of protective covers.

Exterior and Mounting Dimensions

The following table matches each drive model with its appropriate drawing.

2.2 Mechanical Installation

Table 2.2 Drive Models

Protective Design	Drive Model CIMR-J□			Page
	Single-Phase 200 V Class	Three-Phase 200 V Class	Three-Phase 400 V Class	
IP20/Open-Chassis	BA0001B BA0002B BA0003B	2A0001B 2A0002B 2A0004B 2A0006B	–	37
	BA0006B BA0010B	2A0008B 2A0010B 2A0012B 2A0018B 2A0020B	4A0001B 4A0002B 4A0004B 4A0005B 4A0007B 4A0009B 4A0011B	38

Note: Refer to *Specifications on page 187* for information on the amount of heat generated by the drive and appropriate cooling methods.

■ IP20/Open-Chassis Drives

Table 2.3 IP20/Open-Chassis (without an EMC filter)

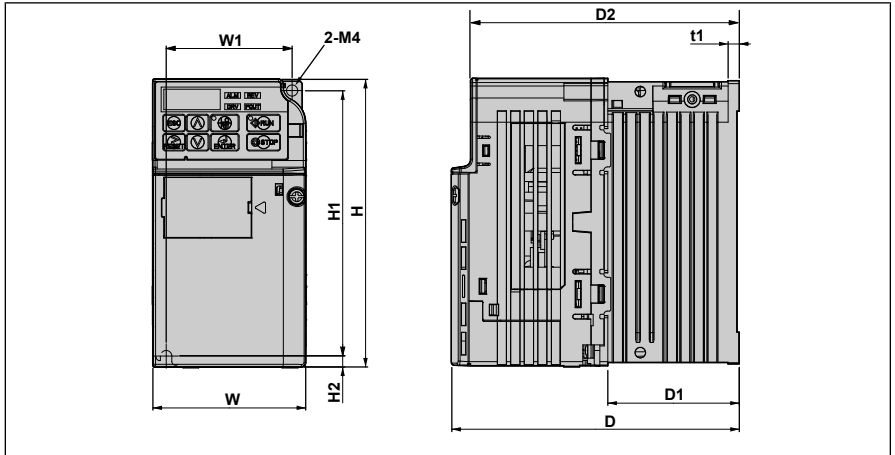

Voltage Class	Drive Model CIMR-J□	Dimensions (mm)									Weight (kg)
		W	H	D	W1	H1	H2	D1	D2	t1	
Single-Phase 200 V Class	BA0001B	68	128	76	56	118	5	6.5	67.5	3	0.6
	BA0002B	68	128	76	56	118	5	6.5	67.5	3	0.6
	BA0003B	68	128	118	56	118	5	38.5	109.5	5	1.0
Three-Phase 200 V Class	2A0001B	68	128	76	56	118	5	6.5	67.5	3	0.6
	2A0002B	68	128	76	56	118	5	6.5	67.5	3	0.6
	2A0004B	68	128	108	56	118	5	38.5	99.5	5	0.9
	2A0006B	68	128	128	56	118	5	58.5	119.5	5	1.1

2.2 Mechanical Installation

Table 2.4 IP20/Open-Chassis (without an EMC filter)

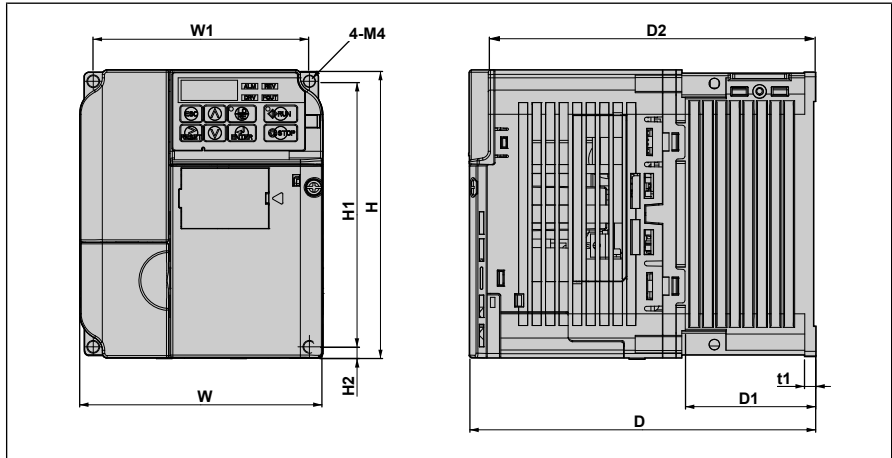

Voltage Class	Drive Model CIMR-J□	Dimensions (mm)									Weight (kg)
		W	H	D	W1	H1	H2	D1	D2	t1	
Single-Phase 200 V Class	BA0006B	108	128	137.5	96	118	5	58	129	5	1.7
	BA0010B	108	128	154	96	118	5	58	145.5	5	1.8
Three-Phase 200 V Class	2A0008B	108	128	129	96	118	5	58	120.5	5	1.7
	2A0010B	108	128	129	96	118	5	58	120.5	5	1.7
	2A0012B	108	128	137.5	96	118	5	58	129	5	1.7
	2A0018B	140	128	143	128	118	5	65	134.5	5	2.4
	2A0020B	140	128	143	128	118	5	65	134.5	5	2.4
Three-Phase 400 V Class	4A0001B	108	128	81	96	118	5	10	72.5	5	1.0
	4A0002B	108	128	99	96	118	5	28	90.5	5	1.2
	4A0004B	108	128	137.5	96	118	5	58	129	5	1.7
	4A0005B	108	128	154	96	118	5	58	145.5	5	1.7
	4A0007B	108	128	154	96	118	5	58	145.5	5	1.7
	4A0009B	108	128	154	96	118	5	58	145.5	5	1.7
	4A0011B	140	128	143	128	118	5	65	134.5	5	2.4



Electrical Installation

This chapter explains proper procedures for wiring the control circuit terminals, motor and power supply.

3.1	SECTION SAFETY.....	40
3.2	STANDARD CONNECTION DIAGRAM.....	43
3.3	MAIN CIRCUIT CONNECTION DIAGRAM.....	46
3.4	TERMINAL BLOCK CONFIGURATION.....	47
3.5	PROTECTIVE COVERS.....	48
3.6	MAIN CIRCUIT WIRING.....	50
3.7	CONTROL CIRCUIT WIRING.....	54
3.8	I/O CONNECTIONS.....	60
3.9	MAIN FREQUENCY REFERENCE.....	63
3.10	BRAKING RESISTOR.....	65
3.11	INTERLOCKING WITH CONNECTED MACHINERY.....	67

3.1 Section Safety

DANGER

Electrical Shock Hazard

Do not connect or disconnect wiring while the power is on.

Failure to comply will result in death or serious injury.

WARNING

Electrical Shock Hazard

Do not operate equipment with covers removed.

Failure to comply could result in death or serious injury.

The diagrams in this section may show drives without covers or safety shields to show details. Be sure to reinstall covers or shields before operating the drives and run the drives according to the instructions described in this manual.

Always ground the motor-side grounding terminal.

Improper equipment grounding could result in death or serious injury by contacting the motor case.

Do not perform work on the drive while wearing loose clothing, jewelry or without eye protection.

Failure to comply could result in death or serious injury.

Remove all metal objects such as watches and rings, secure loose clothing, and wear eye protection before beginning work on the drive.

Do not remove covers or touch circuit boards while the power is on.

Failure to comply could result in death or serious injury.

Do not allow unqualified personnel to perform work on the drive.

Failure to comply could result in death or serious injury.

Installation, maintenance, inspection, and servicing must be performed only by authorized personnel familiar with installation, adjustment, and maintenance of AC drives.

 **WARNING****Do not touch any terminals before the capacitors have fully discharged.**

Failure to comply could result in death or serious injury.

Before wiring terminals, disconnect all power to the equipment. The internal capacitor remains charged even after the power supply is turned off. The charge indicator LED will extinguish when the DC bus voltage is below 50 Vdc. To prevent electric shock, wait at least one minute after all indicators are off and measure the DC bus voltage level to confirm safe level.

Fire Hazard**Tighten all terminal screws to the specified tightening torque.**

Loose electrical connections could result in death or serious injury by fire due to overheating of electrical connections.

Do not use improper combustible materials.

Failure to comply could result in death or serious injury by fire.

Attach the drive to metal or other noncombustible material.

Do not use an improper voltage source.

Failure to comply could result in death or serious injury by fire.

Verify that the rated voltage of the drive matches the voltage of the incoming power supply before applying power.

NOTICE

Observe proper electrostatic discharge procedures (ESD) when handling the drive and circuit boards.

Failure to comply may result in ESD damage to the drive circuitry.

Never connect or disconnect the motor from the drive while the drive is outputting voltage.

Improper equipment sequencing could result in damage to the drive.

Do not use unshielded cable for control wiring.

Failure to comply may cause electrical interference resulting in poor system performance. Use shielded, twisted-pair wires and ground the shield to the ground terminal of the drive.

Check all the wiring to ensure that all connections are correct after installing the drive and connecting any other devices.

Failure to comply could result in damage to the drive.

Do not modify the drive circuitry.

Failure to comply could result in damage to the drive and will void warranty.

Yaskawa is not responsible for any modification of the product made by the user. This product must not be modified.

3.2 Standard Connection Diagram

Connect the drive and peripheral devices as shown in [Figure 3.1](#). It is possible to run the drive via the digital operator without connecting digital I/O wiring. This section does not discuss drive operation; [Refer to Start-Up Programming & Operation on page 69](#) for instructions on operating the drive.

NOTICE: *Inadequate branch short circuit protection could result in damage to the drive. Install adequate branch circuit short circuit protection per applicable codes. The drive is suitable for circuits capable of delivering not more than 30,000 RMS symmetrical amperes, 240 Vac maximum (200 V Class) and 480 Vac maximum (400 V Class).*

NOTICE: *When the input voltage is 440 V or higher or the wiring distance is greater than 100 meters, pay special attention to the motor insulation voltage or use an inverter duty motor. Failure to comply could lead to motor insulation breakdown.*

NOTICE: *Do not connect the AC control circuit ground to the drive enclosure. Improper drive grounding can cause the control circuit to malfunction.*

NOTICE: *The minimum load for the multi-function relay output MA-MB-MC is 10 mA.*

3.2 Standard Connection Diagram

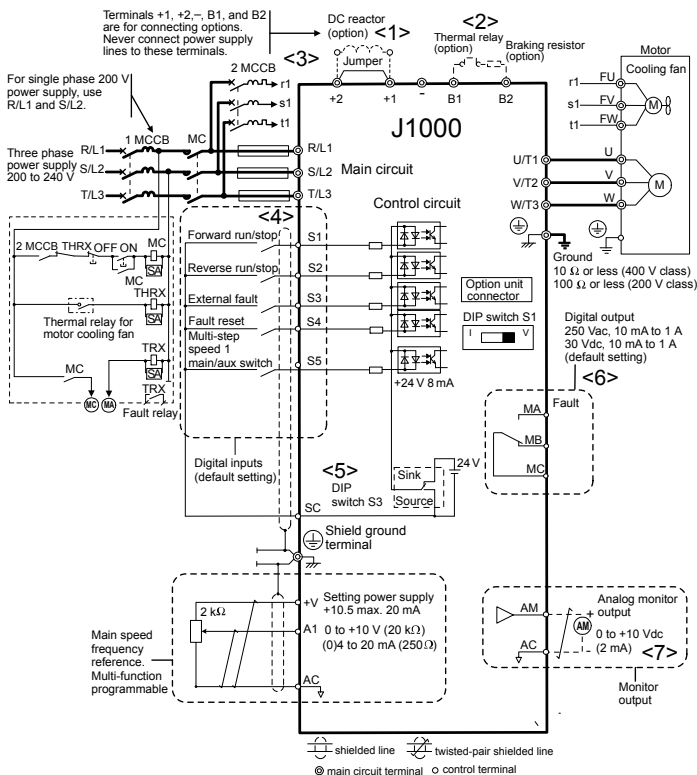

Figure 3.1 Drive Standard Connection Diagram (200 V Class Example)

- <1> Remove the jumper when installing an optional DC reactor.
- <2> The MC on the input side of the main circuit should open when the thermal relay is triggered.
- <3> Self-cooled motors do not require separate cooling fan motor wiring.
- <4> Connected using sequence input signal (S1 to S5) from NPN transistor; Default: sink mode (0 V com).
- <5> Use only a +24 V internal power supply in sinking mode; the source mode requires an external power supply *Refer to I/O Connections on page 60*.
- <6> Minimum load: 5 Vdc, 10 mA (reference value).

3.2 Standard Connection Diagram

<7> Monitor outputs work with devices such as analog frequency meters, ammeters, voltmeters and wattmeters; they are not intended for use as a feedback-type of signal.

WARNING! Sudden Movement Hazard. Do not close the wiring for the control circuit unless the multifunction input terminal parameter is properly set (S5 for 3-Wire; H1-05 = "0"). Improper sequencing of run/stop circuitry could result in death or serious injury from moving equipment.

WARNING! Sudden Movement Hazard. Ensure start/stop and safety circuits are wired properly and in the correct state before energizing the drive. Failure to comply could result in death or serious injury from moving equipment. When programmed for 3-Wire control, a momentary closure on terminal S1 may cause the drive to start.

WARNING! When 3-Wire sequence is used, set the drive to 3-Wire sequence before wiring the control terminals and ensure parameter b1-17 is set to 0 (drive does not accept a run command at power up (default)). If the drive is wired for 3-Wire sequence but set up for 2-Wire sequence (default) and if parameter b1-17 is set to 1 (drive accepts a Run command at power up), the motor will rotate in reverse direction at power up of the drive and may cause injury.

Figure 3.2 illustrates an example of a 3-Wire sequence.

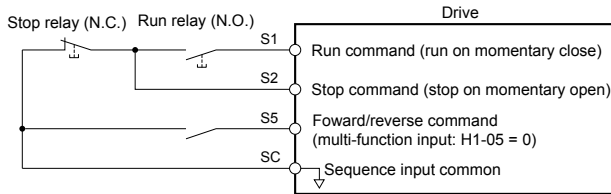

Figure 3.2 3-Wire Sequence

3.3 Main Circuit Connection Diagram

Refer to diagrams in this section for the Main Circuit wiring connections. Connections may vary based on drive capacity. The main circuit DC power supply powers the control circuit.

NOTICE: Do not use the negative DC bus terminal “-” as a ground terminal. This terminal is at high voltage DC potential. Improper wiring connections could result in damage to the drive.

◆ Single-Phase 200 V Class (CIMR-J□BA0001 ~ 0010)

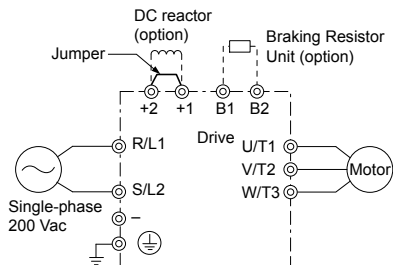

Figure 3.3 Connecting Single-Phase Main Circuit Terminals

NOTICE: Do not connect T/L3 terminal when using single-phase power supply input. Incorrect wiring may damage the drive.

◆ Three-Phase 200 V Class (CIMR-J□2A0001 ~ 0020); Three-Phase 400 V Class (CIMR-J□4A0001 ~ 0011)

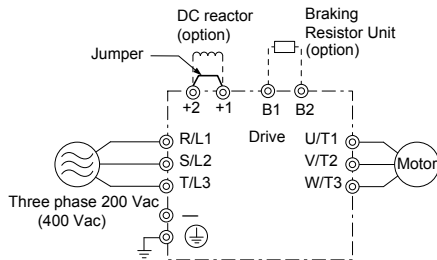

Figure 3.4 Connecting Three-Phase Main Circuit Terminals

3.4 Terminal Block Configuration

The figures in this section provide illustrations of the main circuit terminal block configurations of the different drive sizes.

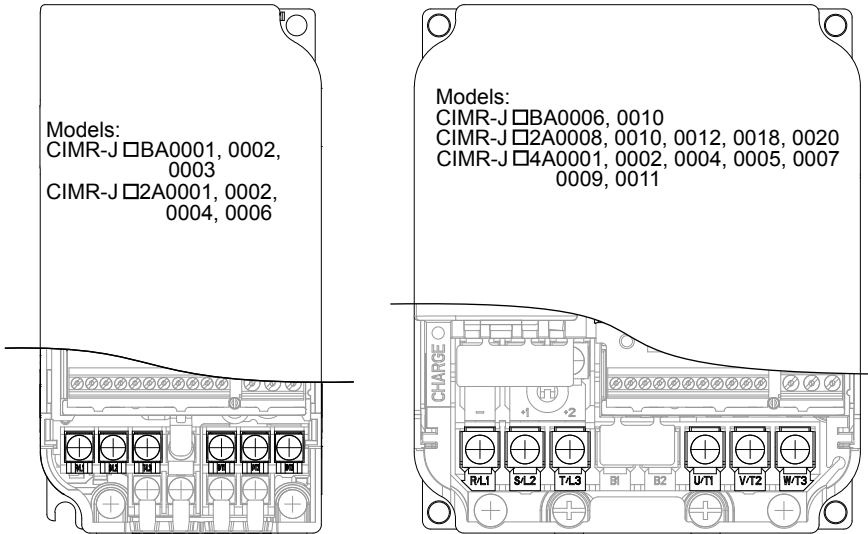

Figure 3.5 Main Circuit Terminal Block Configurations

3.5 Protective Covers

Follow the procedure below to remove the protective covers before wiring the drive and to reattach the covers after wiring is complete.

◆ IP20/Open-Chassis Cover Removal and Installation

■ Removing the Protective Covers

1. Loosen the screw that locks the front cover in place to remove.

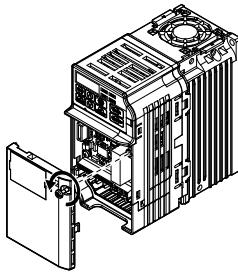

Figure 3.6 Remove the Front Cover on an IP20/Open-Chassis Drive

2. Apply pressure to the tabs on each side of the terminal cover. Pull the terminal cover away from the drive while pushing in on the tabs to pull the cover free.

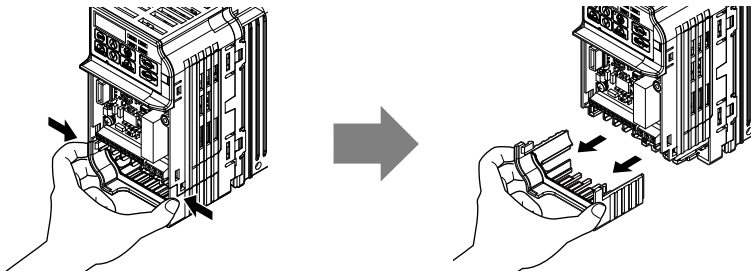

Figure 3.7 Remove the Terminal Cover on an IP20/Open-Chassis Drive

■ Reattaching the Protective Covers

Properly connect all wiring and route power wiring away from control signal wiring. Reattach all protective covers when wiring is complete. Apply only a small amount of pressure to lock the cover back into place.

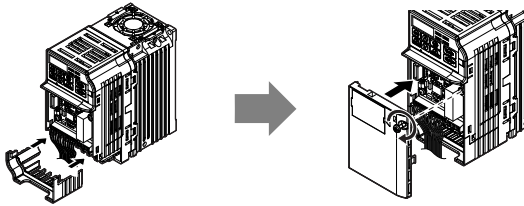

Figure 3.8 Reattach the Protective Covers on an IP20/Open-Chassis Drive

3.6 Main Circuit Wiring

This section describes the functions, specifications, and procedures required to safely and properly wire the main circuit of the drive.

NOTICE: Do not solder the ends of wire connections to the drive. Soldered wiring connections can loosen over time. Improper wiring practices could result in drive malfunction due to loose terminal connections.

◆ Main Circuit Terminal Functions

Table 3.1 Main Circuit Terminal Functions

Terminal	Type	Function	Reference
R/L1	Main circuit power supply input	Connects line power to the drive. Drives with single-phase 200 V input power use terminals R/L1 and S/L2 only (T/L3 must not be used).	46
S/L2			
T/L3			
U/T1	Drive output	Connects to the motor.	52
V/T2			
W/T3			
B1	Braking resistor	Available for connecting a braking resistor or the braking resistor unit option.	65
B2			
+1	DC reactor connection	These terminals are shorted at shipment. Remove the shorting bar between +1 and +2 when connecting to this terminal.	173
+2			
+1	DC power supply input	For connecting a DC power supply.	-
-			
⊕ (2 terminals)	Ground	Grounding Terminal For 200 V class: 100 Ω or less For 400 V class: 10 Ω or less	52

◆ Wire Gauges and Tightening Torque

Select the appropriate wires and crimp terminals from [Table 3.2](#) through [Table 3.4](#).

- Note:**
- Wire gauge recommendations based on drive continuous current ratings using 75 °C 600 Vac vinyl-sheathed wire assuming ambient temperature within 30 °C and wiring distance less than 100 m.
 - Terminals +1, +2, -, B1 and B2 are for connecting optional devices such as a DC reactor or braking resistor. Do not connect other non-specified devices to these terminals.

- Consider the amount of voltage drop when selecting wire gauges. Increase the wire gauge when the voltage drop is greater than 2% of motor rated voltage. Ensure the wire gauge is suitable for the terminal block. Use the following formula to calculate the amount of voltage drop:
- Line drop voltage (V) = $\sqrt{3}$ x wire resistance (Ω/km) x wire length (m) x current (A) x 10^{-3}
- Refer to instruction manual TOBPC72060000 for braking unit or braking resistor unit wire gauges.
- [Refer to UL Standards Compliance on page 236](#) for information on UL compliance.

■ Single-Phase 200 V Class

Table 3.2 Wire Gauge and Torque Specifications

Model CIMR-J□BA	Terminal	Screw Size	Tightening Torque N·m (lb.in.)	Applicable Gauge mm ² (AWG)	Recommended Gauge mm ² (AWG)
0001 0002 0003	R/L1, S/L2, U/T1, V/T2, W/T3, -, +1, +2, B1, B2, ⊕	M3.5	0.8 to 1.0 (7.1 to 8.9)	0.75 to 2.0 (18 to 14)	2 (14)
0006	R/L1, S/L2, U/T1, V/T2, W/T3, -, +1, +2, B1, B2, ⊕	M4	1.2 to 1.5 (10.6 to 13.3)	2.0 to 5.5 (14 to 10)	2 (14)
0010	R/L1, S/L2, U/T1, V/T2, W/T3, ⊕	M4	1.2 to 1.5 (10.6 to 13.3)	2.0 to 5.5 (14 to 10)	3.5 (12)
	-, +1, +2, B1, B2	M4	1.2 to 1.5 (10.6 to 13.3)	2.0 to 5.5 (14 to 10)	5.5 (10)

■ Three-Phase 200 V Class

Table 3.3 Wire Gauge and Torque Specifications

Model CIMR-J□2A	Terminal	Screw Size	Tightening Torque N·m (lb.in.)	Applicable Gauge mm ² (AWG)	Recommended Gauge mm ² (AWG)
0001 0002 0004 0006	R/L1, S/L2, T/L3, U/T1, V/T2, W/ T3, -, +1, +2, B1, B2, ⊕	M3.5	0.8 to 1.0 (7.1 to 8.9)	0.75 to 2.0 (18 to 14)	2 (14)
0008 0010	R/L1, S/L2, T/L3, U/T1, V/T2, W/ T3, -, +1, +2, B1, B2	M4	1.2 to 1.5 (10.6 to 13.3)	2.0 to 5.5 (14 to 10)	2 (14)
	⊕	M4	1.2 to 1.5 (10.6 to 13.3)	2.0 to 5.5 (14 to 10)	3.5 (12)
0012	R/L1, S/L2, T/L3, U/T1, V/T2, W/ T3, -, +1, +2, B1, B2, ⊕	M4	1.2 to 1.5 (10.6 to 13.3)	2.0 to 5.5 (14 to 10)	3.5 (12)
0018 0020	R/L1, S/L2, T/L3, U/T1, V/T2, W/ T3, -, +1, +2, B1, B2, ⊕	M4	1.2 to 1.5 (10.6 to 13.3)	2.0 to 5.5 (14 to 10)	5.5 (10)

■ Three-Phase 400 V Class

Table 3.4 Wire Gauge and Torque Specifications

Model CIMR-J□4A	Terminal	Screw Size	Tightening Torque N·m (lb.in.)	Applicable Gauge mm ² (AWG)	Recommended Gauge mm ² (AWG)
0001 0002 0004 0005 0007	R/L1, S/L2, T/L3, U/T1, V/T2, W/ T3, -, +1, +2, B1, B2, ⊕	M4	1.2 to 1.5 (10.6 to 13.3)	2.0 to 5.5 (14 to 10)	2 (14)
0009	R/L1, S/L2, T/L3, U/T1, V/T2, W/ T3, -, +1, +2, B1, B2	M4	1.2 to 1.5 (10.6 to 13.3)	2.0 to 5.5 (14 to 10)	2 (14)
	⊕	M4	1.2 to 1.5 (10.6 to 13.3)	2.0 to 5.5 (14 to 10)	3.5 (12)

3.6 Main Circuit Wiring

Model CIMR- J□4A	Terminal	Screw Size	Tightening Torque N•m (lb.in.)	Applicable Gauge mm ² (AWG)	Recommended Gauge mm ² (AWG)
0011	R/L1, S/L2, T/L3, U/T1, V/T2, W/ T3, -, +1, +2, B1, B2	M4	1.2 to 1.5 (10.6 to 13.3)	2.0 to 5.5 (14 to 10)	2 (14)
	⊕	M4	1.2 to 1.5 (10.6 to 13.3)	2.0 to 5.5 (14 to 10)	3.5 (12)

◆ Main Circuit Terminal Power Supply and Motor Wiring

This section outlines the various steps, precautions, and checkpoints for wiring the main circuit terminals and motor terminals.

NOTICE: When connecting the motor to the drive output terminals U/T1, V/T2, and W/T3, the phase order for the drive and motor should match. Failure to comply with proper wiring practices may cause the motor to run in reverse if the phase order is backward.

NOTICE: Do not connect phase-advancing capacitors or LC/RC noise filters to the output circuits. Improper application of noise filters could result in damage to the drive.

NOTICE: Do not connect the AC power line to the output motor terminals of the drive. Failure to comply could result in death or serious injury by fire as a result of drive damage from line voltage application to output terminals.

■ Cable Length Between Drive and Motor

When the cable length between the drive and the motor is too long (especially at low frequency output), note that the cable voltage drop may cause reduced motor torque. Drive output current will increase as the leakage current from the cable increases. An increase in leakage current may trigger an overcurrent situation and weaken the accuracy of the current detection.

Adjust the drive carrier frequency according to the following table. If the motor wiring distance exceeds 100 m because of the system configuration, reduce the ground currents.

Refer to [Table 3.5](#) to set the carrier frequency to an appropriate level.

Table 3.5 Cable Length Between Drive and Motor

Cable Length	50 m or less	100 m or less	Greater than 100 m
Carrier Frequency	15 kHz or less	5 kHz or less	2 kHz or less

Note: When setting carrier frequency, calculate the cable length as the total distance of wiring to all connected motors when running multiple motors from a single drive.

■ Ground Wiring

Follow the precautions to wire the ground for one drive or a series of drives.

WARNING! *Electrical Shock Hazard.* Always use a ground wire that complies with technical standards on electrical equipment and minimize the length of the ground wire. Improper equipment grounding may cause dangerous electrical potentials on equipment chassis, which could result in death or serious injury.

WARNING! *Electrical Shock Hazard.* Be sure to ground the drive ground terminal. (200 V Class: Ground to 100 Ω or less, 400 V Class: Ground to 10 Ω or less). Improper equipment grounding could result in death or serious injury by contacting ungrounded electrical equipment.

NOTICE: Do not share the ground wire with other devices such as welding machines or large-current electrical equipment. Improper equipment grounding could result in drive or equipment malfunction due to electrical interference.

NOTICE: When using more than one drive, ground multiple drives according to instructions. Improper equipment grounding could result in abnormal operation of drive or equipment.

Refer to [Figure 3.9](#) when using multiple drives. Do not loop the ground wire.

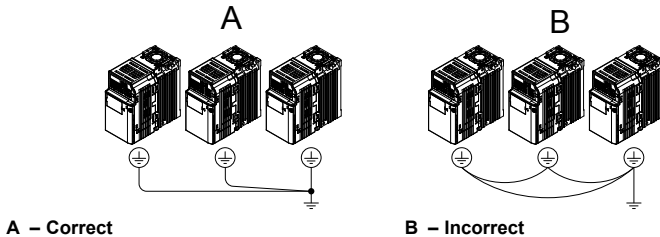
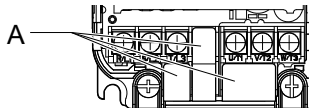

Figure 3.9 Multiple Drive Wiring

■ Wiring the Main Circuit Terminal

WARNING! *Electrical Shock Hazard. Shut off the power supply to the drive before wiring the main circuit terminals. Failure to comply may result in death or serious injury.*

Note: A cover placed over the DC Bus and braking circuit terminals prior to shipment helps prevent miswiring. Cut away covers as needed for terminals with a needle-nose pliers.



A - Protective Cover to Prevent Miswiring

Main Circuit Connection Diagram

Refer to section [3.3 Main Circuit Connection Diagram](#) on page [46](#) for drive main power circuit connections.

WARNING! *Fire Hazard. The braking resistor connection terminals are B1 and B2. Do not connect braking resistors to any other terminals. Improper wiring connections could cause the braking resistor to overheat and cause death or serious injury by fire. Failure to comply may result in damage to the braking circuit or drive.*

3.7 Control Circuit Wiring

NOTICE: Do not solder the ends of wire connections to the drive. Soldered wire connections can loosen over time. Improper wiring practices could result in drive malfunction due to loose terminal connections.

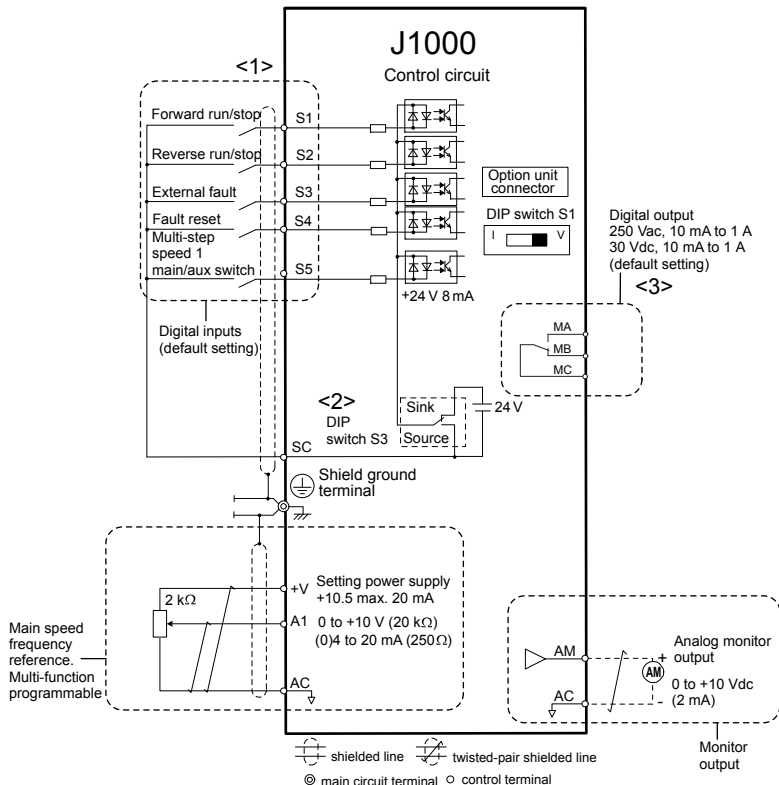

Figure 3.10 Control Circuit Connection Diagram

- <1> Connected using sequence input signal (S1 to S5) from NPN transistor; Default: sink mode (0 V com)
- <2> Use only the +24 V internal power supply in sinking mode; the source mode requires an external power supply. *Refer to I/O Connections on page 60.*
- <3> Minimum load: 5 Vdc, 10 mA (reference value).

◆ Control Circuit Terminal Block Functions

Drive parameters determine which functions apply to the multi-function digital inputs (S1 to S5), and multi-function digital outputs (MA, MB). The default is called out next to each terminal in [Figure 3.10](#).

WARNING! *Sudden Movement Hazard. Always check the operation and wiring of control circuits after being wired. Operating a drive with untested control circuits could result in death or serious injury.*

WARNING! *Confirm the drive I/O signals and external sequence before starting test run. Failure to comply may result in death or serious injury.*

NOTICE: *Do not switch an input contactor more often than once every 30 minutes. Improper equipment sequencing could shorten useful life of the drive electrolytic capacitors and circuit relays. Normally the drive I/O should be used to stop and start the motor.*

■ Input Terminals

Table 3.6 Control Circuit Input Terminals

Type	No.	Terminal Name (Function)	Function (Signal Level) Default Setting
Multi-Function Digital Inputs	S1	Multi-function input 1 (Closed: Forward run, Open: Stop)	24 Vdc, 8 mA Note: Drive preset to sinking mode. When using source mode, set DIP switch S3 to allow for a 24 Vdc ($\pm 10\%$) external power supply. Refer to Sinking/Sourcing Mode Switch on page 60.
	S2	Multi-function input 2 (Closed: Reverse run, Open: Stop)	
	S3	Multi-function input 3 (External fault (N.O.))	
	S4	Multi-function input 4 (Fault reset)	
	S5	Multi-function input 5 (Multi-step speed reference 1)	
	SC	Multi-function input common (Control common)	Sequence common
Main Frequency Reference Input	A1	Frequency reference	Input voltage or input current (Selected by DIP switch S1 and H3-01) 0 to +10 Vdc (20 k Ω), Resolution: 1/1000 4 to 20 mA (250 Ω) or 0 to 20 mA (250 Ω), Resolution: 1/500
	+V	Analog input power supply	+10.5 Vdc (max allowable current 20 mA)
	AC	Frequency reference common	0 Vdc

■ Output Terminals

Table 3.7 Control Circuit Output Terminals

Type	No.	Terminal Name (Function)	Function (Signal Level) Default Setting
Multi-Function Digital Output	MA	N.O. (fault)	Digital output 30 Vdc, 10 mA to 1 A; 250 Vac, 10 mA to 1 A Minimum load: 5 Vdc, 10 mA (reference value)
	MB	N.C. output (fault)	
	MC	Digital output common	
Monitor Output	AM	Analog monitor output	0 to 10 Vdc (2 mA or less) Resolution: 1/256
	AC	Monitor common	0 V

◆ Terminal Configuration

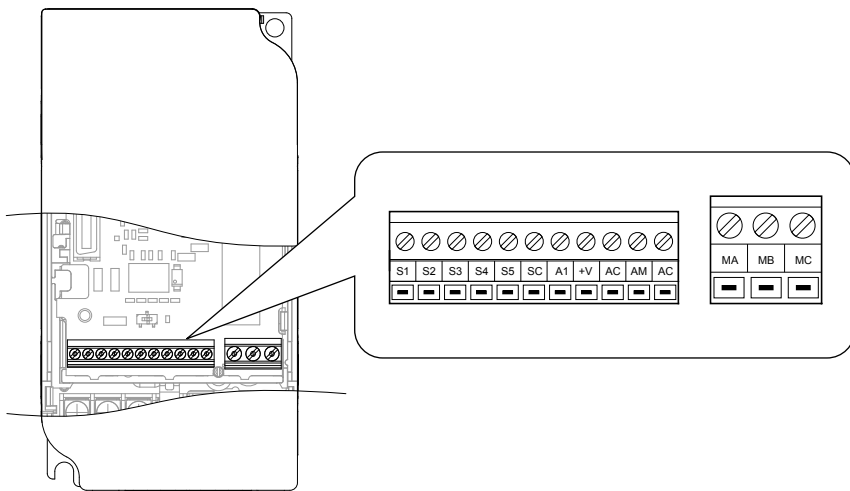

Figure 3.11 Control Circuit Terminal

■ Wire Size and Torque Specifications

Select appropriate wire type and size from [Table 3.8](#). For simpler and more reliable wiring, crimp ferrules to the wire ends. Refer to [Table 3.9](#) for ferrule terminal types and sizes.

Table 3.8 Wire Size and Torque Specifications (Same for All Models)

Terminal	Screw Size	Tightening Torque N·m	Tightening Torque (in-lbs)	Bare Wire Terminal		Ferrule-Type Terminal		Wire Type
				Applicable wire size mm ² (AWG)	Recomm. mm ² (AWG)	Applicable wire size mm ² (AWG)	Recomm. mm ² (AWG)	
MA, MB, MC	M3	0.5 to 0.6	4.4 to 5.3	Stranded: 0.25 to 1.5 (24 to 16) Single: 0.25 to 1.5 (24 to 16)	0.75 (18)	0.25 to 1.0 (24 to 18)	0.5 (20)	Shielded line, etc.
S1-S5, SC, +V, A1, AC, AM	M2	0.22 to 0.25	1.9 to 2.2	Stranded: 0.25 to 1.0 (24 to 18) Single: 0.25 to 1.5 (24 to 16)	0.75 (18)	0.25 to 0.5 (24 to 20)	0.5 (20)	

■ Ferrule-Type Wire Terminations

Crimp a ferrule to signal wiring to improve wiring simplicity and reliability. Use CRIMPFOX ZA-3, a crimping tool manufactured by PHOENIX CONTACT.

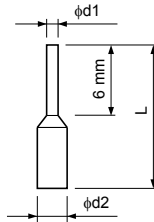

Figure 3.12 Ferrule Dimensions

Table 3.9 Ferrule Terminal Types and Sizes

Size mm ² (AWG)	Type	L (mm)	d1 (mm)	d2 (mm)	Manufacturer
0.25 (24)	AI 0.25-6YE	10.5	0.8	2.0	PHOENIX CONTACT
0.34 (22)	AI 0.34-6TQ	10.5	0.8	2.0	
0.5 (20)	AI 0.5-6WH	12	1.1	2.5	
0.75 (18)	AI 0.75-6GY	12	1.3	2.8	
1.0	AI 1-6RD	12	1.5	3.0	

◆ Wiring Procedure

This section describes the proper procedures and preparations for wiring the control terminals.

WARNING! *Electrical Shock Hazard. Do not remove covers or touch the circuit boards while the power is on. Failure to comply could result in death or serious injury.*

NOTICE: *Separate control circuit wiring from main circuit wiring (terminals R/L1, S/L2, T/L3, B1, B2, U/T1, V/T2, W/T3, -, +1, +2) and other high-power lines. Improper wiring practices could result in drive malfunction due to electrical interference.*

NOTICE: *Separate wiring for digital output terminals MA, MB and MC from wiring to other control circuit lines. Improper wiring practices could result in drive or equipment malfunction or nuisance trips.*

NOTICE: *Use a class 2 power supply (UL standard) when connecting to the control terminals. Improper application of peripheral devices could result in drive performance degradation due to improper power supply.*

NOTICE: *Insulate shields with tape or shrink tubing to prevent contact with other signal lines and equipment. Improper wiring practices could result in drive or equipment malfunction due to short circuit.*

NOTICE: *Connect the shield of shielded cable to the appropriate ground terminal. Improper equipment grounding could result in drive or equipment malfunction or nuisance trips.*

Wire the control terminals using [Figure 3.13](#) as a guide. Prepare the ends of the control circuit wiring as shown in [Figure 3.14](#). [Refer to Wire Size and Torque Specifications on page 56](#).

3.7 Control Circuit Wiring

NOTICE: Do not tighten screws beyond the specified tightening torque. Failure to comply may damage the terminal.

NOTICE: Use shielded twisted-pair cables as indicated to prevent operating faults. Improper wiring practices could result in drive or equipment malfunction due to electrical interference.

Connect control wires as shown in the following figure:

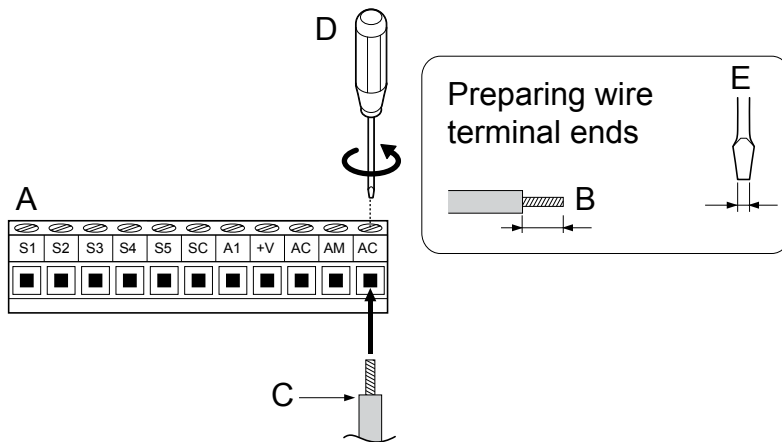

- A – Control terminal block
- B – Avoid fraying wire strands when stripping insulation from wire. Strip length 5.5 mm.
- C – Single wire or stranded wire
- D – Loosen screw to insert wire.
- E – Blade depth of 0.4 mm or less
Blade width of 2.5 mm or less

Figure 3.13 Terminal Board Wiring Guide

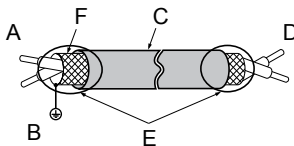

- A – Drive side
- B – Connect shield to ground terminal of drive.
- C – Insulation
- D – Control device side
- E – Shield sheath (Insulate with tape)
- F – Shield

Figure 3.14 Preparing the Ends of Shielded Cables

3.7 Control Circuit Wiring

When setting the frequency by analog reference from an external potentiometer, use shielded twisted-pair wires and ground the shield of twisted-pair wires to the ground terminal of the drive.

NOTICE: The analog signal lines between the drive and the operator station or peripheral equipment should not exceed 50 meters when using an analog signal from a remote source to supply the frequency reference. Failure to comply could result in poor system performance.

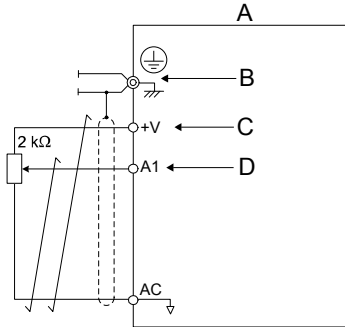

A – Drive

B – Ground terminal (shield connection)

C – (+V) Frequency setting power source
+10.5 Vdc maximum 20 mA

D – (A1) Main speed frequency reference 0
to +10 Vdc (20 kΩ)
or
4 to 20 mA (250 Ω)/
0 to 20 mA (250 Ω)

Figure 3.15 Wiring the Frequency Reference to the Control Circuit Terminals (External Reference)

3.8 I/O Connections

◆ Sinking/Sourcing Mode Switch

Set the DIP switch S3 on the front of the drive to switch the digital input terminal logic between sinking mode and sourcing mode; the drive is preset to sinking mode.

Table 3.10 Sinking/Sourcing Mode Setting

Set Value	Details
SINK	Sinking Mode (0 V common): default setting
SOURCE	Sourcing Mode (+24 V common)

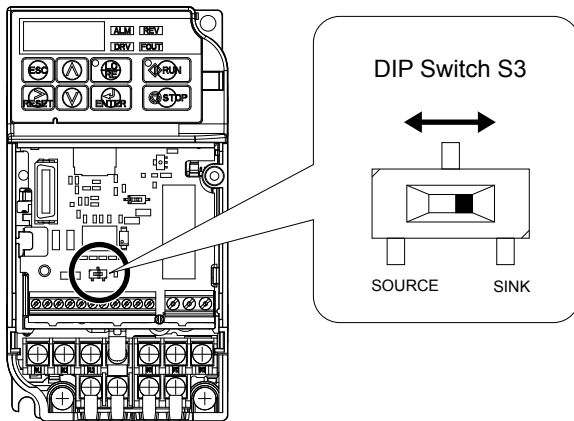

Figure 3.16 DIP Switch S3

■ Transistor Input Signal Using 0 V Common/Sink Mode

When controlling the digital inputs by NPN transistors (0 V common/sinking mode), set the DIP switch S3 to SINK and use the internal 24 V power supply.

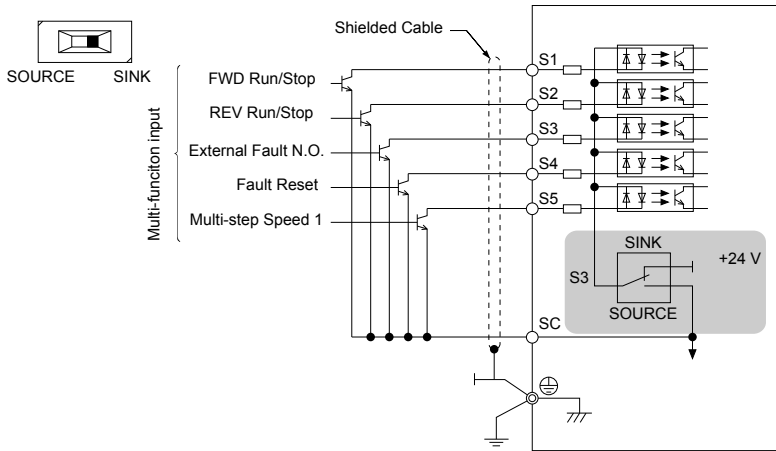

Figure 3.17 Sinking Mode: Sequence from NPN Transistor (0 V Common)

3.8 I/O Connections

■ Transistor Input Signal Using +24 V Common/Source Mode

When controlling digital inputs by PNP transistors (+24 V common/sourcing mode), set the DIP switch S3 to SOURCE and use an external 24 V power supply.

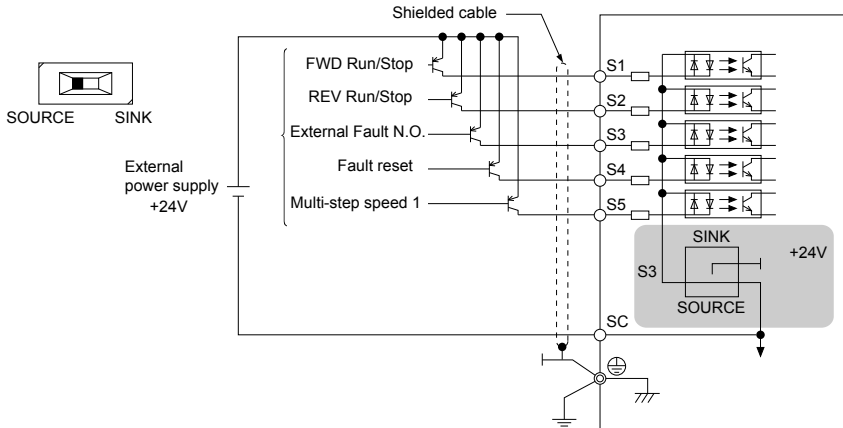

Figure 3.18 Source Mode: Sequence from PNP Transistor (+24 V Common)

3.9 Main Frequency Reference

◆ DIP Switch S1 Analog Input Signal Selection

The main frequency reference can either be a voltage or current signal input.

To use current input at terminal A1, set the DIP switch S1 to "I" (default setting) and set parameter H3-01 = "2" or "3" (4-20 mA or 0-20 mA).

When using as a voltage input, set DIP switch S1 to "V" (right position) and program parameter H3-01 to "0" (0 to +10 Vdc with lower limit) or "1" (0 to +10 Vdc without lower limit).

Table 3.11 Frequency Reference Configurations

Voltage Input	Current Input

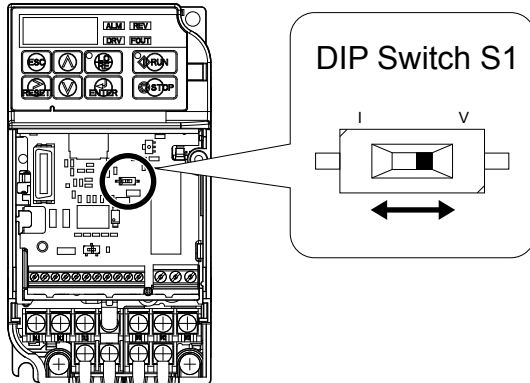

Figure 3.19 DIP Switch S1

3.9 Main Frequency Reference

Table 3.12 DIP Switch S1 Settings

Setting Value	Description
V (right position)	Voltage input (0 to 10 V): default setting
I (left position)	Current input (4 to 20 mA or 0 to 20 mA)

Table 3.13 Parameter H3-01 Details

No.	Parameter Name	Description	Setting Range	Default Setting	MEMOBUS Register
H3-01	Frequency ref. (voltage/current) terminal A1 signal level selection	Selects the signal level for terminal A1. 0: 0 to +10 V, unipolar input (negative frequency reference values are zeroed) 1: 0 to +10 V, bipolar input (negative frequency reference changes the direction) 2: 4 to 20 mA 3: 0 to 20 mA	0 to 3	0	410H

3.10 Braking Resistor

Dynamic braking (DB) helps bring the motor to a smooth and rapid stop when working with high inertia loads. As the drive lowers the frequency of a motor with high inertia connected, regeneration occurs. This can cause an overvoltage situation when the regenerative energy flows back into the DC bus capacitors. A braking resistor prevents these overvoltage faults.

NOTICE: *Do not allow unqualified personnel to use the product. Failure to comply could result in damage to the drive or braking circuit. Carefully review the braking resistor instruction manual when connecting a braking option to the drive.*

Note: The braking circuit must be sized properly in order to dissipate the power required to decelerate the load in the desired time. Ensure that the braking circuit can dissipate the energy for the set deceleration time prior to running the drive.

NOTICE: *Use a thermal overload relay or an over-temperature contact to interrupt input power to the drive in the event the braking resistor overheats. In the event of a possible thermal overload, the relay will trigger the input contactor and prevent the braking resistor from burning up.*

◆ Installation

WARNING! *Fire Hazard. The braking resistor connection terminals are B1 and B2. Do not connect a braking resistor directly to any other terminals. Improper wiring connections could result in death or serious injury by fire. Failure to comply may result in damage to the braking circuit or drive.*

NOTICE: *Connect braking resistors to the drive as shown in the I/O wiring examples. Improperly wiring braking circuits could result in damage to the drive or equipment.*

■ Installation Procedure

1. Disconnect all electrical power to the drive and wait at least one minute before servicing the drive and any connected components.
2. Remove drive front cover.
3. Use a voltmeter to verify that voltage is disconnected from incoming power terminals and that the DC bus no longer holds a charge.

3.10 Braking Resistor

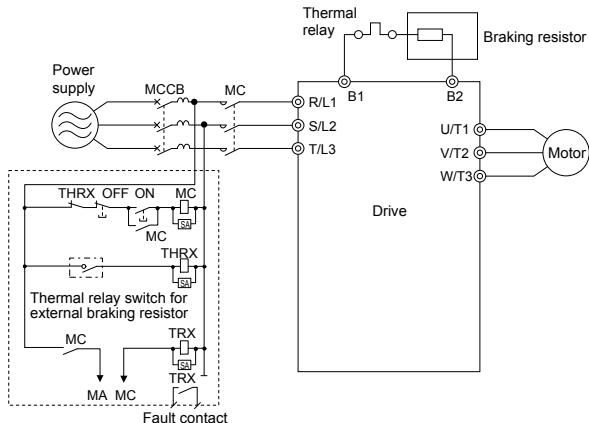

Figure 3.20 Connecting a Braking Resistor

4. Follow manufacturer instructions to connect the resistor unit to the drive using proper wire gauge according to local electrical codes.

Power leads for the remote mount resistors generate high levels of electrical noise; group these signal leads separately.

5. Mount the resistor unit on a noncombustible surface. Maintain minimum side and top clearances according to resistor manufacturer instructions.

WARNING! Fire Hazard. Do not use improper combustible materials. Failure to comply could result in death or serious injury by fire. Attach the drive or braking resistors to metal or other noncombustible material.

6. Reinstall drive covers and resistor covers, if provided.
7. Set parameter L3-04 = "0" to disable stall prevention during deceleration.
Set parameter L8-01 to "1" to enable overheat protection when using Yaskawa heatsink-mounted braking resistor.
Set L8-01 = "0" for other braking resistor types.

Table 3.14 Braking Resistor Settings

Parameter	Settings
L8-01: Internal Dynamic Braking Resistor Protection Selection	0: Disabled. The drive will not provide overheat protection. Supply separate means of overheat protection. 1: Enabled. Braking Resistor is protected from overheat.
L3-04: Stall Prevention During Deceleration	0: Stall prevention disabled.

8. Operate the system and verify the required deceleration rate is obtained during dynamic braking or stopping.

3.11 Interlocking with Connected Machinery

For safety reasons, applications that may be affected by the operation status of the drive should be set up so that operation can only occur when the drive is ready to operate. A "Drive ready" and "Fault" signal should be assigned to the multi-function outputs to guarantee interlock with application.

◆ Drive Ready Signal

The "Drive ready" signal is output to one of the multi-function terminals after the drive has booted up and there is no fault present. It indicates that the drive is ready for operation.

- The power is off.
- A fault situation is present.
- There is a problem with the drive internal power supply.
- Parameter settings restrict a Run command from being entered.
- An overvoltage or undervoltage situation is present so that when the Run command is given a fault is immediately triggered.
- The drive is in the programming mode and parameter settings restrict a Run command from being entered in the programming mode.

This Page Intentionally Blank



Start-Up Programming & Operation

This chapter explains the functions of the LED operator and how to program the drive for initial operation.

4.1	SECTION SAFETY.....	70
4.2	USING THE DIGITAL LED OPERATOR.....	73
4.3	THE DRIVE AND PROGRAMMING MODES.....	78
4.4	START-UP FLOWCHARTS.....	86
4.5	BASIC OPERATION.....	87
4.6	POWERING UP THE DRIVE.....	111
4.7	NO-LOAD OPERATION TEST RUN.....	113
4.8	TEST RUN WITH LOAD CONNECTED.....	115
4.9	VERIFYING AND BACKING UP PARAMETER SETTINGS.....	116

4.1 Section Safety

DANGER

Electrical Shock Hazard

Do not connect or disconnect wiring while the power is on.

Failure to comply will result in death or serious injury.

WARNING

Electrical Shock Hazard

Do not operate equipment with covers removed.

Failure to comply could result in death or serious injury.

The diagrams in this section may include drives without covers or safety shields to illustrate details. Be sure to reinstall covers or shields before operating the drives and run the drives according to the instructions described in this manual.

Always ground the motor-side grounding terminal.

Improper equipment grounding could result in death or serious injury by contacting the motor case.

Do not touch any terminals before the capacitors have fully discharged.

Failure to comply could result in death or serious injury.

Before wiring terminals, disconnect all power to the equipment. The internal capacitor remains charged even after the power supply is turned off. The charge indicator LED will extinguish when the DC bus voltage is below 50 Vdc. To prevent electric shock, wait at least one minute after all indicators are off and measure the DC bus voltage level to confirm safe level.

Do not allow unqualified personnel to perform work on the drive.

Failure to comply could result in death or serious injury.

Installation, maintenance, inspection, and servicing must be performed only by authorized personnel familiar with installation, adjustment and maintenance of AC drives.

 **WARNING**

Do not perform work on the drive while wearing loose clothing, jewelry or without eye protection.

Failure to comply could result in death or serious injury.

Remove all metal objects such as watches and rings, secure loose clothing, and wear eye protection before beginning work on the drive.

Do not remove covers or touch circuit boards while the power is on.

Failure to comply could result in death or serious injury.

Fire Hazard

Tighten all terminal screws to the specified tightening torque.

Loose electrical connections could result in death or serious injury by fire due to overheating of electrical connections.

Do not use an improper voltage source.

Failure to comply could result in death or serious injury by fire.

Verify that the rated voltage of the drive matches the voltage of the incoming power supply before applying power.

Do not use improper combustible materials.

Failure to comply could result in death or serious injury by fire.

Attach the drive to metal or other noncombustible material.

NOTICE

Observe proper electrostatic discharge procedures (ESD) when handling the drive and circuit boards.

Failure to comply may result in ESD damage to the drive circuitry.

Never connect or disconnect the motor from the drive while the drive is outputting voltage.

Improper equipment sequencing could result in damage to the drive.

Do not use unshielded cable for control wiring.

Failure to comply may cause electrical interference resulting in poor system performance. Use shielded twisted-pair wires and ground the shield to the ground terminal of the drive.

Do not allow unqualified personnel to use the product.

Failure to comply could result in damage to the drive or braking circuit.

Carefully review instruction manual TOBPC72060000 when connecting a braking option to the drive.

Do not modify the drive circuitry.

Failure to comply could result in damage to the drive and will void warranty.

Yaskawa is not responsible for any modification of the product made by the user. This product must not be modified.

Check all the wiring to ensure that all connections are correct after installing the drive and connecting any other devices.

Failure to comply could result in damage to the drive.

4.2 Using the Digital LED Operator

Use the LED operator to enter run and stop commands, display data, edit parameters, as well as display fault and alarm information.

◆ Keys, Displays, and LEDs

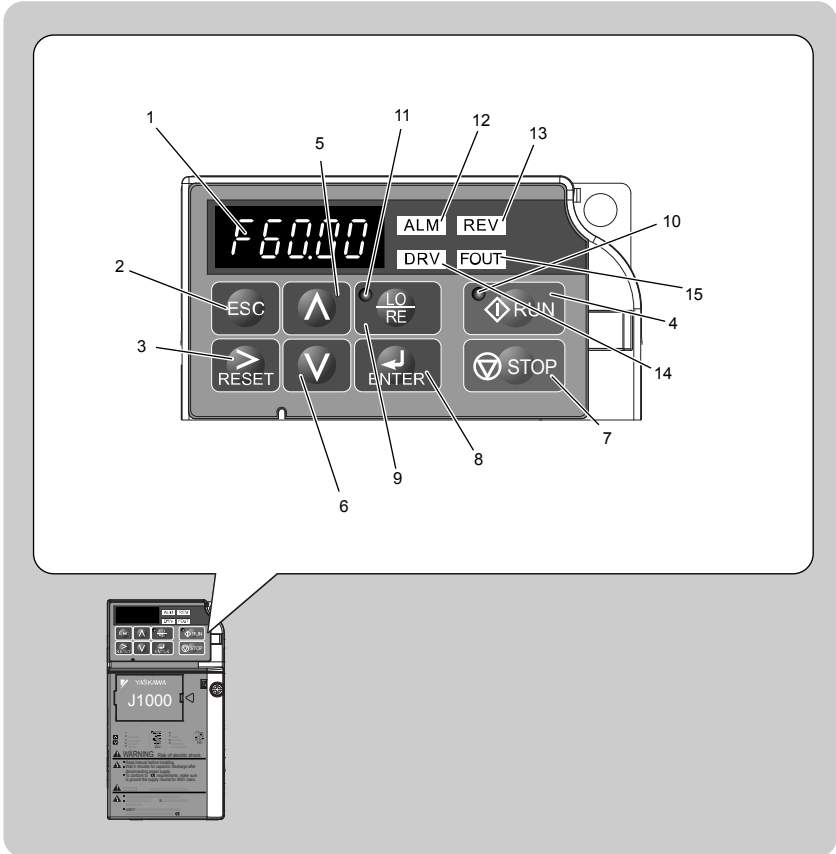

4.2 Using the Digital LED Operator

Table 4.1 Keys and Displays on the LED Operator

No.	Display	Name	Function
1		Data Display Area	Displays the frequency reference, parameter number, etc.
2		ESC Key	Returns to the previous menu.
3		RESET Key	Moves the cursor to the right. Resets the drive to clear a fault situation.
4		RUN Key	Starts the drive.
5		Up Arrow Key	Scrolls up to select parameter numbers, setting values, etc.
6		Down Arrow Key	Scrolls down to select parameter numbers, setting values, etc.
7		STOP Key	Stops the drive. Note: Stop priority circuit. A fast-stop is available by pressing the STOP key when the drive detects a danger even if the drive is running by a signal from the multi-function contact input terminal (REMOTE is set). To avoid stoppage by using the STOP key, set o2-02 (STOP Key Function Selection) to 0 (Disabled).
8		ENTER Key	Selects all modes, parameters, settings, etc. Selects a menu item to move from one display screen to the next.
9		LO/RE Selection Key	Switches drive control between the operator (LOCAL) and the control circuit terminals (REMOTE). Note: LOCAL/REMOTE key effective during stop in drive mode.
10		RUN Light	Lit while the drive is operating the motor.
11		LO/RE Light	Lit while the operator (LOCAL) is selected to run the drive.
12		ALM LED Light	<i>Refer to LED Screen Displays on page 75.</i>
13		REV LED Light	
14		DRV LED Light	
15		FOUT LED Light	

◆ Digital Text Display

Text appears on the LED Operator as shown below. This section explains the meaning of text as it appears on the display screen.

Lit	Flashing

4.2 Using the Digital LED Operator

Text	LED	Text	LED	Text	LED	Text	LED
0	0	9	9	I	i	R	r
1	1	A	A	J	j	S	S
2	2	B	b	K	k	T	t
3	3	C	c	L	L	U	U
4	4	D	d	M	m	V	v
5	5	E	E	N	n	W	w
6	6	F	F	O	o	X	none
7	7	G	G	P	p	Y	y
8	8	H	H	Q	q	Z	none

<1> Displayed in two digits.

◆ LED Screen Displays

Display	Lit	Flashing	Off
ALM	When the drive detects an alarm or error	<ul style="list-style-type: none"> When an alarm occurs oPE detected 	Normal state (no fault or alarm)
REV	Motor is rotating in reverse	—	Motor is rotating forward
DRV	Drive Mode	—	Programming Mode
FOUT	Displays output frequency (Hz)	—	—
As illustrated in this manual			

◆ LO/RE LED and RUN LED Indications

LED	Lit	Flashing	Flashing Quickly <1>	Off
	When run command is selected from LED operator (LOCAL)	—	—	Run command is selected from device other than LED operator (REMOTE)
	During run	<ul style="list-style-type: none"> During deceleration to stop When a run command is input and frequency reference is 0 	<ul style="list-style-type: none"> During deceleration at a fast-stop. During stop by interlock operation. 	During stop

4.2 Using the Digital LED Operator

LED	Lit	Flashing	Flashing Quickly <*>	Off
As shown				

<1> Refer to [Figure 4.1](#) for the difference between “flashing” and “flashing quickly”.

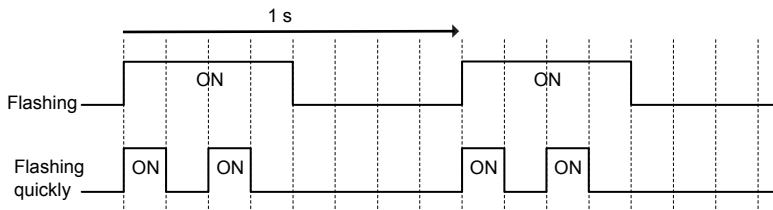

Figure 4.1 RUN LED Status and Meaning

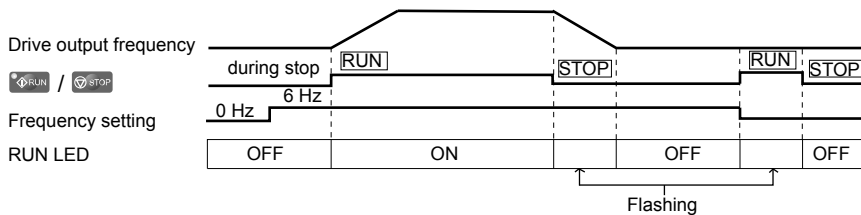

Figure 4.2 RUN LED and Drive Operation

◆ Menu Structure for Digital LED Operator

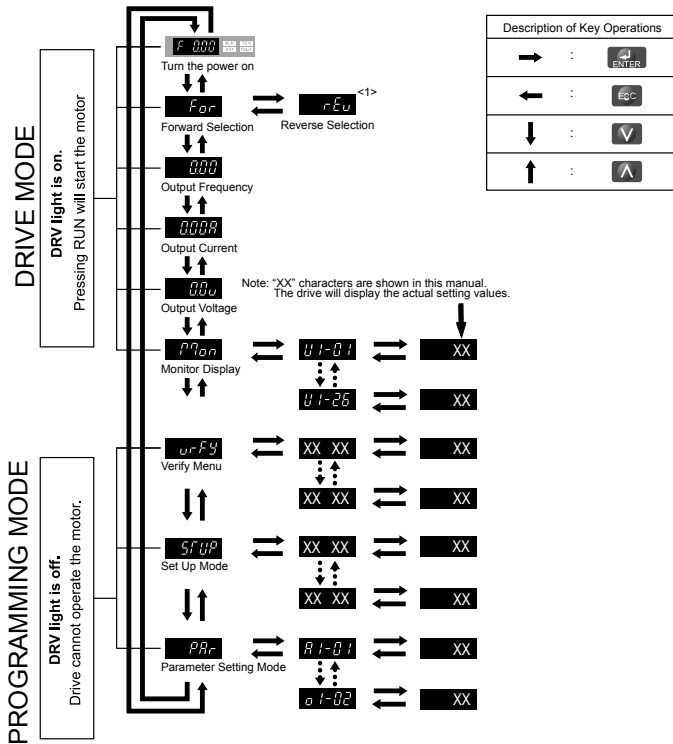

Figure 4.3 Digital LED Operator Screen Structure

<1> Reverse can only be selected when LOCAL is set.

4.3 The Drive and Programming Modes

The drive functions are divided into two main groups accessible via the Digital LED Operator:

Drive Mode: The Drive mode allows motor operation and parameter monitoring. Parameter settings cannot be changed when accessing functions in the Drive Mode (*Table 4.3*).

Programming Mode: The Programming Mode allows access to setup/adjust, verify parameters. The drive prohibits changes in motor operation such as start/stop when the Digital LED Operator is accessing a function in the Programming Mode.

Table 4.3 illustrates the different functions visible as the “Up arrow” is scrolled immediately after powering up the drive.

Note: When b1-08 (Run Command Selection while in Programming Mode) is set to 1 (enabled), the drive can run even if the mode is switched to the programming mode. When setting b1-08 to 0 (disabled), the mode cannot be switched to the programming mode while the drive is running.



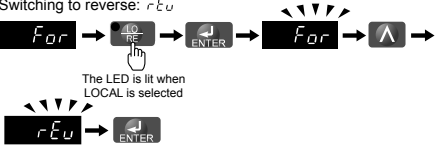



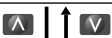
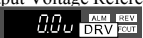

Table 4.3 Summary of Modes

Mode Group	Description	Key Press	LED Digital Operator Display
Drive Mode Functions (Motor operation and monitoring)	Frequency Reference Display (Initial power-up state)		
	Forward/Reverse		
	Output Frequency Display		
	Output Current Display		
	Output Voltage Reference		
	Monitor Display		
Programming Mode Functions (Changing parameters)	Verify Function		
	Setup Group Parameters		
	All Parameters		





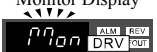

◆ Navigating the Drive and Programming Modes

The drive is set to operate in Drive Mode when it is first powered up. Switch between display screens by using the and keys.

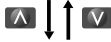
4.3 The Drive and Programming Modes

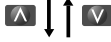
<p>Power Up</p>	<p>Frequency Reference</p> 	<p>This display screen allows the user to monitor and set the frequency reference while the drive is running. <i>Refer to The Drive and Programming Modes on page 78.</i> Note: The user can select items to display when the drive is first powered up by setting parameter o1-02.</p>
<p>Drive Mode</p>	<p>Default Setting</p> 	
	<p>Forward/Reverse</p> 	<p><i>For</i>: Motor rotates forward. <i>REV</i>: Motor rotates in reverse. Note: For applications that should not run in reverse (fans, pumps, etc.), set parameter b1-04 = “1” to prohibit the motor from rotating in reverse. This sequence also puts the drive in LOCAL mode. Switching to reverse: <i>REV</i></p>  <p>The LED is lit when LOCAL is selected</p>
		
	<p>Output Frequency Display</p> 	<p>Monitors the frequency output by the drive.</p>
		
	<p>Output Current Display</p> 	<p>Monitors the output current of the drive.</p>
		
<p>Drive Mode</p>	<p>Output Voltage Reference</p> 	<p>Monitors the output voltage of the drive.</p>
		
	<p>Monitor Display</p> 	<p>Monitor parameters (U parameters) are displayed.</p>

4.3 The Drive and Programming Modes

Programming Mode		
	Verify Function 	Lists all parameters that have been edited or changed from default settings. → Refer to Verifying Parameter Changes: Verify Menu on page 83 .
		
	Setup 	A select list of parameters necessary to get the drive operational quickly. → Refer to The Setup Group within the Programming Mode on page 81 .
		
	Parameter Setting 	Allows the user to access and edit all parameter settings. → Refer to Parameter List on page 197 .
Drive Mode	Frequency Reference 	Returns to the frequency reference display screen.

■ Drive Mode Details

The following actions are possible in the Drive Mode:

- Run and stop the drive.
- Monitor the operation status of the drive (frequency reference, output frequency, output current, output voltage, etc.).
- View information on an alarm.

Note: Select "Drive Mode" when running. The mode can be switched to any mode (program mode, etc.) other than drive mode while the drive is stopped. However, the drive cannot be operated in other modes. Return the mode to "Drive Mode" after completing periodic inspection.

Figure 4.4 illustrates changing the default frequency reference of F 0.00 (0 Hz) to F 6.00 (6 Hz) while in Drive Mode. This example assumes the drive is set to LOCAL.

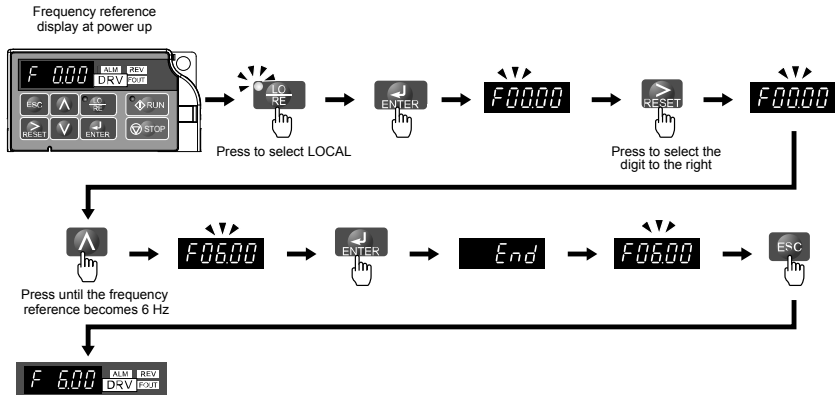

Figure 4.4 Setting the Frequency Reference while in Drive Mode

Note: The drive will not accept a frequency reference set value unless the ENTER key is pressed after the frequency reference is entered. This feature prevents accidental setting of the frequency reference. By setting o2-05 (Frequency Reference Setting Method Selection) to 1 (Enabled), the drive will accept the frequency reference while it is being adjusted on the digital operator.

■ Programming Mode Details

The following actions are possible in the programming mode:

- **Verify Function:** Verify parameter setting changes from original default values.
- **Setup Group:** Access a list of commonly used parameters to simplify setup.
- **Parameter Setting Mode:** Access and edit all parameter settings.

The Setup Group within the Programming Mode

In Setup Group, the user can access the minimum group of parameters required to operate the application.

Note: Setup Group parameters are listed in [Table 4.4](#).

[Figure 4.5](#) illustrates the keys to press to enter the Setup Group.

In this example, the source of the frequency reference is changed from the control circuit terminals to the LED Operator (i.e., b1-01 is changed from 1 to 0).

4.3 The Drive and Programming Modes

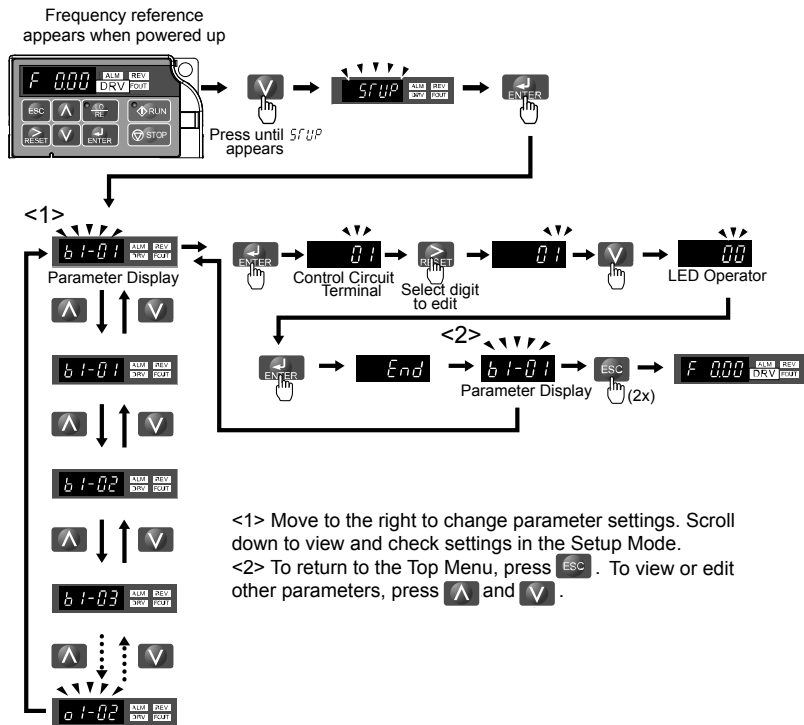















Figure 4.5 Setup Group Example

◆ Changing Parameter Settings or Values

This example explains changing C1-01 (Acceleration Time 1) from 10.0 seconds (default) to 20.0 seconds.

Step	Display/Result
1. Turn on the power to the drive. The initial display appears.	
2. Press the ▲ key until the Setup Mode Screen appears.	
3. Press the ENTER key to view the parameter setting display.	

Step			Display/Result
4.	Scroll through parameters by pressing the  key until C1-01 appears.	→	
5.	Press  to view the current setting value (10.0). (Number farthest to the left flashes)	→	
6.	Press  until the desired number is selected. ("1" flashes)	→	
7.	Press the  key and enter 0020.0.	→	
8.	Press  and the drive will confirm the change.	→	
9.	The display automatically returns to the screen shown in Step 4.	→	
10.	Press the  key until back at the initial display.	→	









◆ Verifying Parameter Changes: Verify Menu

The Verify Menu lists edited parameters from the Programming Mode. The Verify Menu helps determine which settings have been changed, and is particularly useful when replacing a drive. If no settings have been changed the Verify Menu will read *no nE*. The Verify menu also allows users to access and re-edit edited parameters.



Note: The Verify Menu will not display parameters from the A1 group even if those parameters have been changed from default settings.

The following example is a continuation of the steps beginning on page 82. Here, parameter C1-01 is accessed using the Verify Menu and is changed again to 20.0 s.

To check the list of edited parameters:

Step			Display/Result
1.	Turn on the power to the drive. The initial display appears.	→	
2.	Press  until the display shows the "Verify" representation.	→	
3.	Press  to enter the list of parameters that have been edited from their original default settings. Scroll through the list by pressing the  key.	→	
4.	Press the  key until C1-01 appears.	→	

4.3 The Drive and Programming Modes

Step		Display/Result
5.	Press the  key to access the setting value. (number farthest to the left flashes)	→ 

◆ Switching Between LOCAL and REMOTE



Entering the run command using the LED operator is referred to as LOCAL, while entering the run command from an external device via the control circuit terminals or network option unit is referred to as REMOTE.

WARNING! Sudden Movement Hazard. The drive may start unexpectedly if the Run command is already applied when switching from LOCAL mode to REMOTE mode when b1-07 = 1, resulting in death or serious injury. Be sure all personnel are clear of rotating machinery and electrical connections prior to switching between LOCAL mode and REMOTE mode.

There are two ways to switch between LOCAL and REMOTE.

- Note:**
1. After selecting LOCAL, the LO/RE light will remain lit.
 2. The drive will not allow the user to switch between LOCAL and REMOTE during run.

■ Using the LO/RE Key on the LED Operator

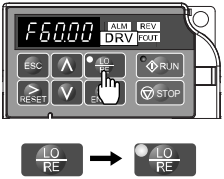
Step		Display/Result
1.	Turn on the power to the drive. The initial display appears.	→ 
2.	Press  . The LO/RE light will light up. The drive is now in Local. To set the drive for REMOTE operation, press the  key again.	→ 

■ Using Input Terminals S1 through S5 to Switch between LO/RE

Switch between LOCAL and REMOTE using one of the digital input terminals S1 through S5 (set the corresponding parameter H1-01 through H1-05 to “1”).

Follow the example below to set the digital input terminals.

- Note:**
1. For a list of digital input selections, [Refer to Parameter List on page 197.](#)
 2. Setting a multi-function input terminal to a value of 1 disables the LO/RE key on the LED operator.

◆ Parameters Available in the Setup Group

■ Setup Mode (STUP)

Parameters used for this drive are classified into A to U. To simplify the drive setup, frequently used parameters are selected and input into Setup Mode.

1. To set a parameter, the Setup Mode must be displayed first. Press the Up/Down key until \overline{STUP} is displayed.
2. Select the parameter and change the setting. [Table 4.4](#) lists parameters available in the Setup group. If the desired parameter cannot be set in the Setup mode, use the Parameter Setting mode.

Note: This manual also explains other parameters not visible in the Setup Group (A1-06 = 0). Use the “Par” menu in the Programming mode to access parameters not listed in the Setup Group.

Table 4.4 Setup Group Parameters

Parameter	Name	Parameter	Name
b1-01	Frequency Reference Selection	d1-17	Jog Frequency Reference
b1-02	Run Command Selection	E1-01	Input Voltage Reference
b1-03	Stop Method Selection	E1-04	Maximum Output Frequency
C1-01	Acceleration Time 1	E1-05	Maximum Voltage
C1-02	Deceleration Time 1	E1-06	Base Frequency
C6-01	Duty Selection	E1-09	Minimum Output Frequency
C6-02	Carrier Frequency Selection	E2-01	Motor Rated Current
d1-01	Frequency Reference 1	H4-02	Terminal FM Gain Setting
d1-02	Frequency Reference 2	L1-01	Motor Protection Function Selection
d1-03	Frequency Reference 3	L3-04	Stall Prevention Selection during Deceleration
d1-04	Frequency Reference 4		

4.4 Start-up Flowcharts

This section summarizes the basic steps required to start the drive. The chart is intended as a quick reference to help familiarize the user with start-up procedures.

◆ Flowchart: Basic Start-up and Motor Tuning

Figure 4.6 describes basic start-up sequence for the drive and motor system. This sequence varies slightly depending on application. Use drive default parameter settings in simple applications that do not require high precision.

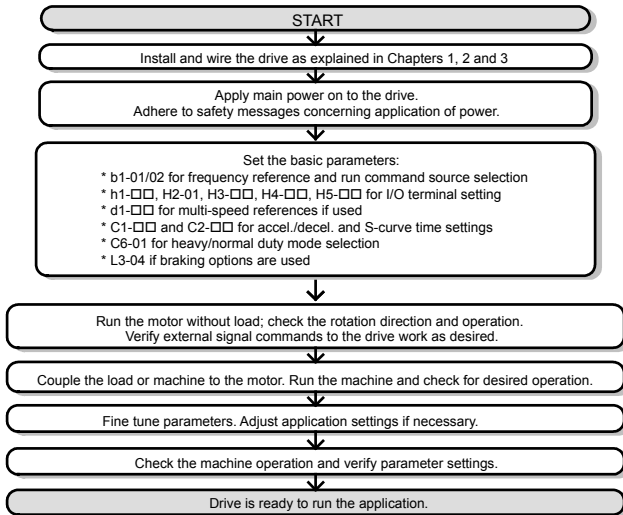

Figure 4.6 Basic Start-Up and Motor Tuning

4.5 Basic Operation

This section explains the basic settings required for initial drive operation. Checking these basic parameter settings during start-up will help to ensure a successful drive start-up.

If more information is required for parameters not listed in this section, [Refer to Parameter List on page 197](#) as required for a complete listing of drive parameters.

◆ Initialize Parameter Values: A1-03

Parameter A1-03 (Initialize Parameters) resets all parameters to the original default values.

Note: Record all the changed settings before initializing parameters.

■ Different Methods of Drive initialization

2220: 2-Wire Initialization

Returns all parameters to factory default values for 2-wire control.

3330: 3-Wire Initialization

Returns all parameters to factory default values for 3-wire control.

◆ Frequency Reference Source: b1-01

This section explains how to assign the frequency reference. Parameters b1-01 and b1-02 can be used to select the source of the run command and the frequency reference independently (e.g., set the reference from the operator and set the run command from the terminals).

■ Frequency Reference from the LED Operator: b1-01 = 0

When b1-01 = 0 the frequency reference will be provided by the LED operator. [Refer to The Drive and Programming Modes on page 78](#) for information on how to set the frequency reference.

■ Frequency Reference from the Analog Input Terminal: b1-01 = 1

When b1-01 = 1, analog input A1 provides the frequency reference.

Note: Set H3-01 (Terminal A1 Function Selection) to “0” to configure Terminal A1 for the main analog frequency reference.

Voltage Input

When entering the frequency reference with a voltage signal, set parameter H3-01 to “0” for 0 to 10 Vdc with lower reference limit. Set H3-01 to “1” if 0 to 10 Vdc input without lower limit is required. Set DIP Switch S1 for voltage input (position “V”).

4.5 Basic Operation

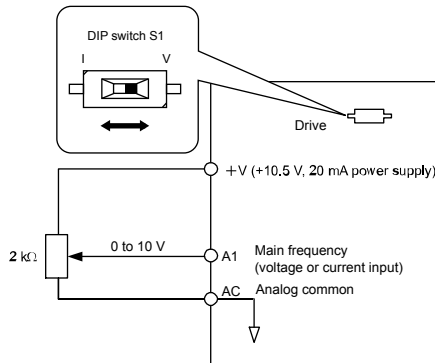

Figure 4.7 Voltage Input for the Frequency Reference

Current Input

When entering the frequency reference using an analog input signal, set parameter H3-01 to “2” if 4 to 20 mA input is used. When using 0 to 20 mA input, set H3-01 to “3”. Set DIP Switch S1 for current input (position “I”).

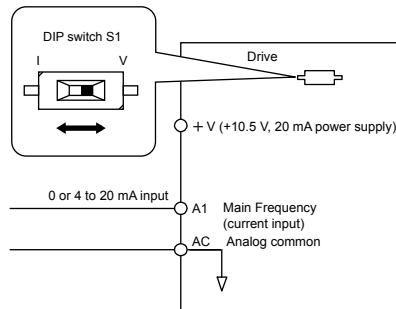

Figure 4.8 Current Input for the Frequency Reference

◆ Run Command Input Selection: b1-02

This section explains how to assign the run command input.

Parameters b1-01 and b1-02 can be used to select the source of the run command and the frequency reference independently, e.g. set the reference from the operator and set the run command from the terminals.

WARNING! *Sudden Movement Hazard. When the run command is given by turning on the power to the drive, the motor will begin rotating as soon as the drive is powered up. Be sure to take proper precautions if using this setting. Ensure the area around the motor is safe. Failure to comply could result in death or serious injury.*









■ Run the Drive at 6 Hz using the LED Operator: b1-02 = 0

To assign the run command to the operator panel, set parameter b1-02 to “0”. This will set up the drive to acknowledge the run command through the LED operator. Initialize the run command using the Run and Stop keys. Upon power up, the drive uses parameter b1-02 to determine the run command location.

The following procedure indicates how to start and stop the drive through the LED operator after parameter b1-02 has been set to 0.

Note:

When b1-02 (Run Command Selection) is not set to 0 (operator), press  to set LOCAL.

Step		Display/Result
1.	Turn on the power to the drive. The initial display appears.	
2.	Set the frequency reference to F6.00 (6 Hz). Note: Refer to Drive Mode Details on page 80 for instructions on how to set the frequency reference.	
3.	Press the  key to start the motor.	
4.	The motor should accelerate up to 6 Hz while the RUN light is on.	  off →  on
5.	Press the  key to stop the motor. The RUN light will flash until the motor comes to a complete stop.	 flashing →  off

■ Run the Drive using Digital Input Terminals: b1-02 = 1

This setting uses the digital input terminals to enter the run command. The factory setting is a 2-wire sequence.

4.5 Basic Operation

Using a 2-Wire Sequence

Digital Input Terminals	ON	OFF
S1	Forward Run	Stop
S2	Reverse Run	Stop

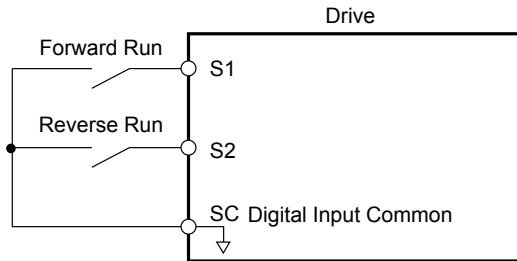

Figure 4.9 Example Wiring Diagram for 2-Wire Sequence

Using a 3-Wire Sequence

When H1-05 (Multi-Function Digital Input Terminal S5 Function Selection) = 0, the functions of terminals S1 and S2 are set to 3-wire sequence, and the multi-function input terminal becomes forward/reverse run command terminal.

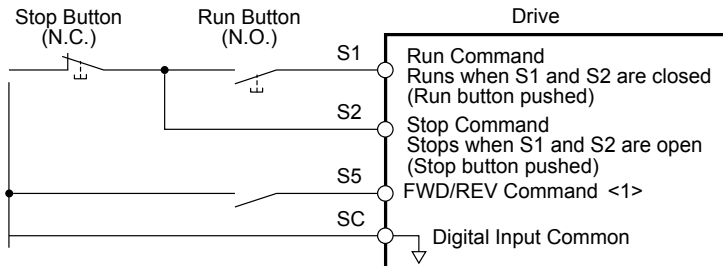

Figure 4.10 Example Wiring Diagram for 3-Wire Sequence Using Terminal S5

<1> When terminal S5 is open, the motor rotates forward. When closed, the motor rotates in reverse.

WARNING! When 3-Wire sequence is used, set the drive to 3-Wire sequence before wiring the control terminals and ensure parameter b1-17 is set to 0 (drive does not accept a run command at power up (default)). If the drive is wired for 3-Wire sequence but set up for 2-Wire sequence (default) and if parameter b1-17 is set to 1 (drive accepts a Run command at power up), the motor will rotate in reverse direction at power up of the drive and may cause injury.

Note: Refer to [Parameter List on page 197](#) for a list of digital input functions. After performing a 3-wire initialization (A1-03 = "3"), the drive will automatically assign the forward/reverse command to terminal S5.

Note: Run by Turning on/off the Power Supply. For safety reasons, the drive is initially set up not to accept a run command at power up (b1-17 = "0"). If a run command is issued at power up, the RUN indicator LED will flash quickly. To change this and have the run command issued by the drive, change parameter b1-17 to 1.

◆ Stopping Method Selection: b1-03

When a Stop command is issued, the drive stops the motor using one of two possible methods.

■ Ramp to Stop: b1-03 = 0

When b1-03 = 0, the motor will decelerate to a stop when a stop command is entered. The deceleration time is set by C1-02 (Deceleration Time 1). [Refer to Acceleration/Deceleration: C1-01 to C1-04 on page 92.](#)

When the output frequency falls below E1-09 (Minimum Output Frequency) during deceleration, the DC Injection braking current (b2-02) will be activated for the specified DC Injection time at stop (b2-04).

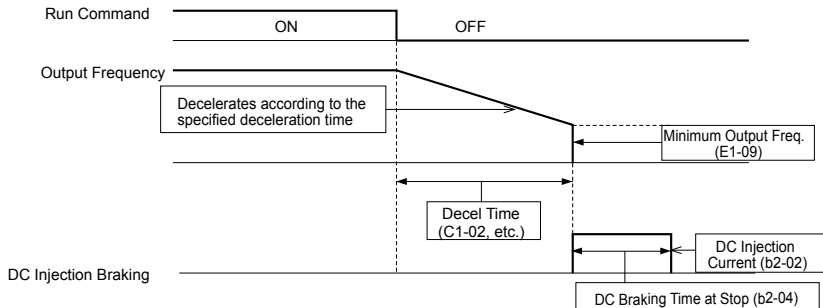

Figure 4.11 Ramp to Stop

■ Coast to Stop: b1-03 = 1

When the run command is removed, the drive will shut off its output and the motor will coast (uncontrolled deceleration). The motor will coast to a stop at the rate determined by the load inertia.

4.5 Basic Operation

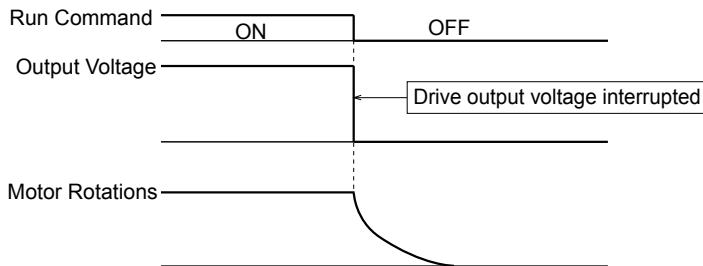

Figure 4.12 Coast to Stop

- Note:**
1. After entering a stop command, the drive will not accept another run command until the time set passes.
 2. Do not enter another run command until the motor comes to a complete stop. If a run command must be entered before the motor has fully stopped, use DC Injection to slow the motor or catch the motor before restarting.

◆ Acceleration/Deceleration: C1-01 to C1-04

C1-01 (Acceleration Time 1) sets the time to accelerate from 0 to the maximum output frequency (E1-04). C1-02 (Deceleration Time 1) sets the time to decelerate from maximum output frequency to 0.

No.	Parameter Name	Description	Setting Range	Default
C1-01 </>	Acceleration Time 1	Sets the time to accelerate from 0 to 100% (maximum output frequency).	0.0 to 6000.0	10.0 s
C1-02 </>	Deceleration Time 1	Sets the time to decelerate from 100% (maximum output frequency) to 0%.		

</> The parameter can be changed during run.

WARNING! *Sudden Movement Hazard. Rapid deceleration may cause the drive to fault on an overvoltage condition, resulting in death or serious injury due to an uncontrolled motor state. Set an acceptable deceleration time in parameter C1-09 when using the Fast-stop feature.*

■ Switching Accel/Decel Times with Digital Input Terminals

Two acceleration / deceleration times can be selected using one of the digital input terminals S1 through S5.

Program one of the parameters H1-01 through H1-05 to “07” (Accel/Decel Time). Opening or closing the digital input changes the accel/decels times as shown below:

Accel/Decel Time H1-□□ = 7	Acceleration Time	Deceleration Time
Open (not selected)	C1-01	C1-02

Accel/Decel Time H1-□□ = 7	Acceleration Time	Deceleration Time
Closed	C1-03	C1-04

■ Using S-Curve Characteristics during Acceleration/Deceleration

Using S-curve characteristics to smooth acceleration and deceleration minimizes abrupt shock to the load. Set S-curve characteristic time during acceleration/deceleration at start and acceleration/deceleration at stop.

Note: Setting S-curve characteristics will lengthen accel/decel times as follows:

$$\text{Accel Time} = \text{Selected Accel Time} + (C2-01 + C2-02)/2$$

$$\text{Decel Time} = \text{Selected Decel Time} + (C2-03 + C2-04)/2$$

Setting Example

Figure 4.13 illustrates S-curve characteristics switching between forward and reverse.

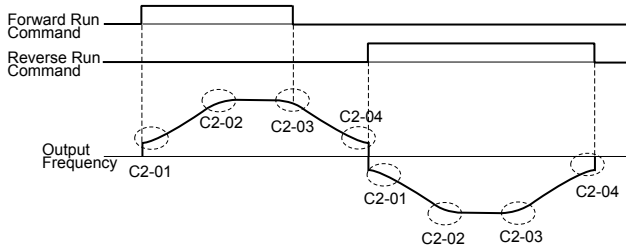

Figure 4.13 S-Curve Characteristics

◆ Drive Duty Mode and Carrier Frequency Selection: C6-01 and C6-02

■ Drive Duty Mode Selection: C6-01

The drive has two different duty modes from which to select based on the load characteristics. The drive rated current, overload capacity, carrier frequency, and maximum output frequency will change depending upon the duty mode selection. Use parameter C6-01 (Duty Cycle) to select Heavy Duty (HD) or Normal Duty (ND) for the application. The default setting is ND. *Refer to Specifications on page 187* for details about the rated current.

HD and ND Mode Selections

Mode	HD Rating	ND Duty Rating
C6-01	0	1

4.5 Basic Operation

Mode	HD Rating	ND Duty Rating
Characteristics		
Application	Use HD Rating is designed applications requiring a high overload tolerance with constant load torque, like conveyors.	Use ND Rating for applications in which the torque requirements drop along with the speed. Examples include fans or pumps where a high overload tolerance is not required.
Overload capability (oL2)	100% continuous, 150% of drive rated current for 60 s	100% continuous, 120% of drive rated current for 60 s
C6-02	1 : 2.0 kHz 2 : 5.0 kHz 3 : 8.0 kHz 4 : 10.0 kHz 5 : 12.5 kHz 6 : 15.0 kHz 7: Swing PWM F : User defined (C3-03 to C3-05)	1 : 2.0 kHz 2 : 5.0 kHz 3 : 8.0 kHz 4 : 10.0 kHz 5 : 12.5 kHz 6 : 15.0 kHz 7: Swing PWM F : User defined (C3-03 to C3-05)
L3-02 Stall Prevention during Acceleration	150%	120%
L3-06 Stall Prevention during Run	150%	120%

Note: By selecting HD/ND, motor parameter E2 is changed to the value for the maximum applicable motor.

Note: Swing PWM uses 2.0 kHz carrier frequency as a base. The application of special PWM patterns keeps the audible noise of the motor low.

■ Carrier Frequency Selection: C6-02

Fixed Carrier Frequencies

The carrier frequency can be set using parameter C6-02 as shown in table below.

Parameter	Name	Description	Setting Range	Default
C6-02	Carrier frequency	1 : 2.0 kHz 2 : 5.0 kHz 3 : 8.0 kHz 4 : 10.0 kHz 5 : 12.5 kHz 6 : 15.0 kHz 7 : Swing PWM F : User defined (C3-03 to C3-05)	1 to F	Depends on drive size

Note: Settings 7 through A for parameter C6-02 use a Swing PWM equivalent to a 2 kHz audible noise. This function turns the motor noise into a less obtrusive white noise.

Note: The upper limit for the carrier frequency is determined by drive capacity.

Precautions when setting parameter C6-02:

Symptom	Possible Solution
Speed and torque are unstable at low speeds.	Lower the carrier frequency.
Noise from the drive is affecting peripheral devices.	
Excessive leakage current from the drive.	
Wiring between the drive and motor is too long. </>	Increase the carrier frequency or use Swing PWM.
Motor acoustic noise is too loud.	

</> The carrier frequency may need to be lowered if the motor cable is too long. Refer to the table below.

Wiring Distance	Up to 50 m	Up to 100 m	Greater than 100 m
C6-02 (Carrier Frequency Selection)	1 to F (15 kHz)	1 to 2 (5 kHz), 7	1 (2 kHz), 7

Carrier Frequency Setting Error (oPE11)

A carrier frequency setup error (oPE11) will occur when carrier frequency gain (C6-05) is greater than 6 and C6-03 < C6-04.

Note: [Refer to Troubleshooting without Fault Display on page 143](#) for information on operator errors (oPE).

■ Carrier Frequency and Drive Overload Current Level

With C6-01 set to 1, the carrier frequency setting defines drive output current level.

Table 4.5 Current Derating by Carrier Frequency Setting

Single-Phase 200 V			Three-Phase 200 V			Three-Phase 400 V		
Model (Capacity)	Carrier Frequency (kHz)	Output Current (A)	Model (Capacity)	Carrier Frequency (kHz)	Output Current (A)	Model (Capacity)	Carrier Frequency (kHz)	Output Current (A)
BA0001 0.2 kW/ 0.1 kW	2	1.2	2A0001 0.2 kW/ 0.1 kW	2	1.2	—	—	—
	10	0.8		10	0.8			
	15	0.6		15	0.6			
BA0002 0.4 kW/ 0.2 kW	2	1.9	2A0002 0.4 kW/ 0.2 kW	2	1.9	4A0001 0.4 kW/ 0.2 kW	2	1.2
	10	1.6		10	1.6		8	1.2
	15	1.3		15	1.3		15	0.7

4.5 Basic Operation

Single-Phase 200 V			Three-Phase 200 V			Three-Phase 400 V		
Model (Capacity)	Carrier Frequency (kHz)	Output Current (A)	Model (Capacity)	Carrier Frequency (kHz)	Output Current (A)	Model (Capacity)	Carrier Frequency (kHz)	Output Current (A)
BA0003 0.75 kW/ 0.4 kW	2	3.3	2A0004 0.75 kW/ 0.4 kW	2	3.3	4A0002 0.75 kW/ 0.4 kW	2	2.1
	10	3.0		10	3.0		8	1.8
	15	2.4		15	2.4		15	1.1
BA0006 1.1 kW/ 0.75 kW	2	6.0	—	—	—	4A0004 1.5 kW/ 0.75 kW	2	4.1
	10	5.0					8	3.4
	15	4.0					15	2.0
—	—	—	2A0006 1.1 kW/ 0.75W	2	6.0	—	—	—
				10	5.0			
				15	4.0			
—	—	—	2A0008 1.5 kW/ 1.1 kW	2	8.0	—	—	—
				8	6.9			
				15	5.5			
BA0010 2.2 kW/ 1.5W	2	9.6	2A0010 2.2 kW/ 1.5W	2	9.6	4A0005 2.2 kW/ 1.5W	2	5.4
	8	8.0		8	8.0		8	4.8
	15	6.4		15	6.4		15	2.9
—	—	—	2A0012 3.0 kW/ 2.2 kW	2	12.0	4A0007 3.0 kW/ 2.2 kW	2	6.9
				8	11.0		8	5.5
				15	8.8		15	3.3
—	—	—	2A0018 3.7 kW/ 3.0W	2	17.5	4A0009 3.7 kW/ 3.0 kW	2	8.8
				8	14.0		8	7.2
				15	11.2		15	4.3
—	—	—	2A0020 5.5 kW/ 4.0 kW	2	19.6	4A0011 5.5 kW/ 4.0 kW	2	11.1
				8	17.5		8	9.2
				15	14.0		15	5.5

◆ Multi-Step Speed Operation (4-Step Speed)

Select up to 9 preset references (including Jog reference) using two multi-function inputs S4 and S5. Two multi-step references can be selected using two multi-function inputs as illustrated in [Figure 4.14](#).

■ Multi-Step Speed Operation Parameters

No.	Name	Description
d1-01	Frequency Reference 1	Frequency reference. o1-03 determines the units, with Hz as the default.
d1-02	Frequency Reference 2	Frequency reference when multi-function input "Multi-Step Speed Reference 1" (H1-□□ = 3) is on. Setting unit: set by o1-03.
d1-03	Frequency Reference 3	Frequency reference when multi-function input "Multi-Step Speed Reference 2" (H1-□□ = 4) is on. Setting unit: set by o1-03.

No.	Name	Description
d1-04	Frequency Reference 4	Frequency reference when multi-function input "Multi-Step Speed Reference 1, 2" (H1-□□ = 3 and 4) are both on. Setting unit: set by o1-03.

■ Digital Input

Terminal	Parameter	Setting	Contents
S4	H1-04	4	Multi-Step Speed Reference 2
S5	H1-05	3	Multi-Step Speed Reference 1

■ Wiring Example

Set up external switches SW1 and SW2.

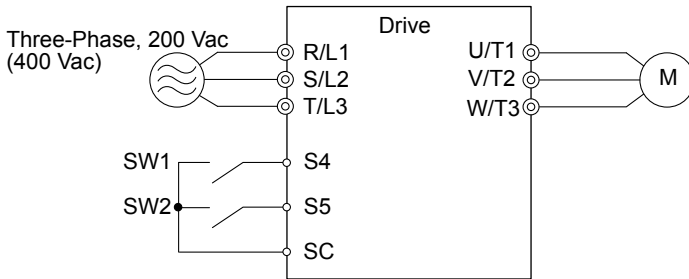

Figure 4.14 Control Terminals for 4 Multi-Step Speeds

4.5 Basic Operation

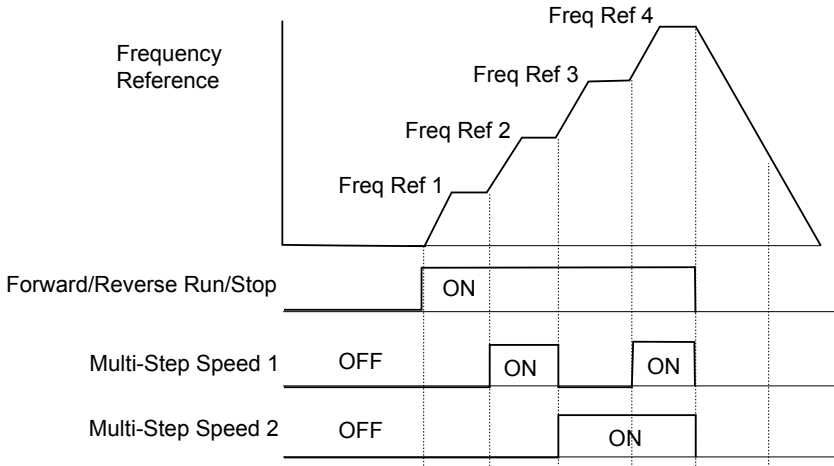













Figure 4.15 4-Step Speed Time Chart

■ Setting Procedure

Step	Display/Result
1. Turn on the power to the drive. The initial display appears.	
2. Set the frequencies listed below to the specified parameters: 1. d1-01 = 5 Hz: Step 1 </> 2. d1-02 = 20 Hz: Step 2 3. d1-03 = 50 Hz: Step 3 4. d1-04 = 60 Hz: Step 4	
3. Press the key until the initial display appears.	
4. turns on.	
5. Press to select LOCAL. The LO/RE light will turn on.	

Step		Display/Result
6.	Press  to run the motor at 5 Hz. The RUN light will turn on.	  →  Off On
7.	With SW1 closed, the drive runs the motor at Multi-Step Speed 2 (20 Hz).	
8.	With SW1 open and SW2 closed, the drive runs the motor at Multi-Step Speed 3 (50 Hz).	
9.	With both SW1 and SW2 closed, the drive runs the motor at Multi-Step Speed 4 (60 Hz).	
10.	Press  to stop the drive. The RUN light will flash until the motor comes to a complete stop.	  →  Flashing Off

<|> When the frequency reference is assigned to the LED operator (b1-01=0), the first step in a multi-step speed sequence comes from d1-01.

Note: When a run command is input from the control circuit terminal, the frequency reference value is selected as follows:
 When b1-01 = 0 and the run command is given, the drive uses the frequency set to d1-01.
 When b1-01 = 1 and the run command is given, the drive uses the frequency reference value input to analog control terminal A1.

◆ Drive Input Voltage Setting: E1-01

Set E1-01 according to the power supply voltage. This setting serves as a base value for certain drive protective functions.

NOTICE: Set drive input voltage (not motor voltage) in parameter E1-01 for proper function of the protective features of the drive. Failure to comply could result in improper drive operation. Set parameter E1-01 to match the input voltage of the drive.

Parameter	Name	Description	Setting Range	Default
E1-01	Input Voltage Setting	Set to the nominal voltage of the incoming line. Sets the maximum and base voltage, and adjusts the levels of drive protective features (e.g., overvoltage, braking resistor level, stall prevention, etc.).	200 V Class: 155 to 255 400 V Class: 310 to 510	200 V

4.5 Basic Operation

■ Input Voltage Setting Value: E1-01

The input voltage level determines the overvoltage detection level and the operation level of the braking transistor as shown in the table below.

Voltage	Setting Value of E1-01	(Approximate Values)		
		ov Detection Level	Braking Transistor Operation Level	Uv Detection Level
200 V Class	All settings	410 V	394 V	190 V (single-phase=160 V)
400 V Class	Setting \geq 400V	820 V	788 V	380 V
	Setting $<$ 400V	740 V	708 V	350 V

Note: This data is for an internal dynamic braking resistor of 0.1 to 18.5 kW. For larger units, see “Dynamic Braking Resistor Unit for VARISPEED-600 Series, TOBPC72060000.”

◆ V/f Pattern Settings: E1-04 to E1-10

Depending on the application, it may be necessary to adjust the V/f pattern. [Figure 4.16](#) illustrates parameters that need to be set up to adjust the V/f pattern characteristics.

■ Instructions for Setting a V/f Pattern

1. Set the input voltage for the drive. [Refer to Drive Input Voltage Setting: E1-01 on page 99.](#)
2. Set the V/f pattern:

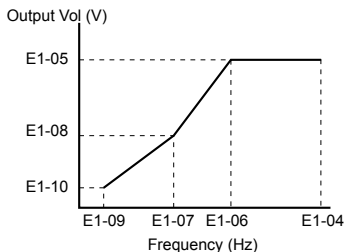

Figure 4.16 V/f Pattern

No.	Parameter Name
E1-04	Maximum Output Frequency
E1-05	Maximum Voltage
E1-06	Base Frequency
E1-07	Mid Output Frequency

No.	Parameter Name
E1-08	Mid Output Frequency Voltage
E1-09	Minimum Output Frequency
E1-10	Minimum Output Frequency Voltage

Table 4.6 V/f Pattern Examples

Setting Example	Specification	Characteristic	Application
0	50 Hz	Constant torque	For general purpose applications, torque remains constant regardless of speed changes.
1	60 Hz (default setting)		
2	60 Hz (with 50 Hz base)		
3	72 Hz (with 60 Hz base)		
4	50 Hz Heavy Duty 3	Reduced or variable torque	For applications where torque changes with the speed like fans, pumps, and others that require reduced torque relative to the load.
5	50 Hz Heavy Duty 2		
6	60 Hz Heavy Duty 3		
7	60 Hz Heavy Duty 2		
8	50 Hz mid starting torque	High starting torque	High starting should be selected only when: <ul style="list-style-type: none"> • Wiring between the drive and motor exceeds 150 m • Large amount of starting torque is required • AC reactor is installed • Motor exceeds the largest motor recommended for that drive used
9	50 Hz high starting torque		
A	60 Hz mid starting torque		
B	60 Hz high starting torque		
C	90 Hz (with 60 Hz base)	Constant output	When operating at speeds greater than 60 Hz motor requires constant voltage. When operating at speeds greater than 60 Hz motor operates in constant power range.
D	120 Hz (with 60 Hz base)		
E	180 Hz (with 60 Hz base)		

■ V/f Pattern Characteristics

These graphs apply to 200 V class drives; double the values for 400 V class drives.

- Constant Torque Characteristics

4.5 Basic Operation

Setting Examples 0 through 3

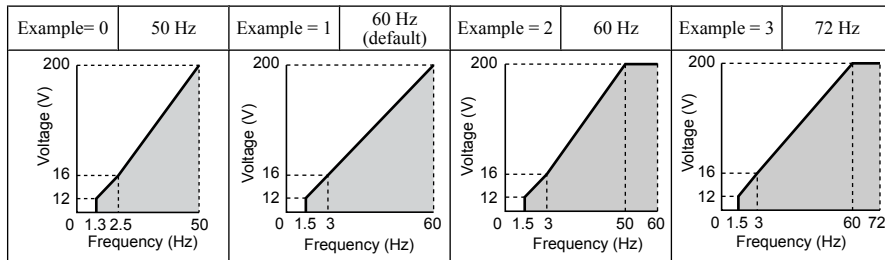

- Reduced Torque Characteristics
Setting Examples 4 through 7

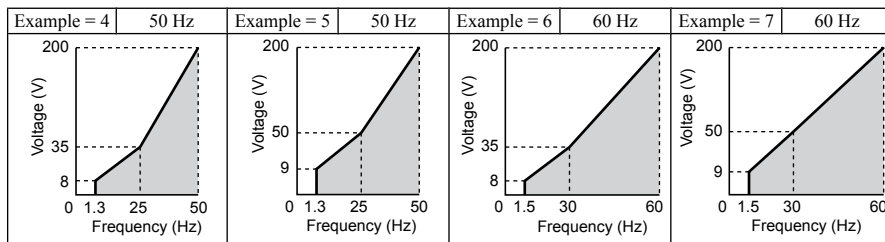

- High Starting Torque Characteristics
Setting Examples 8 through B

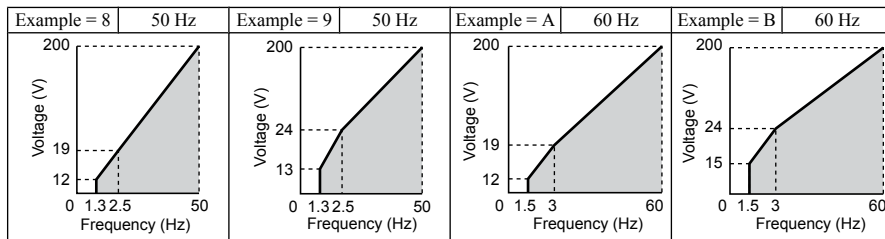

- Constant Output Characteristics

Setting Examples C through E

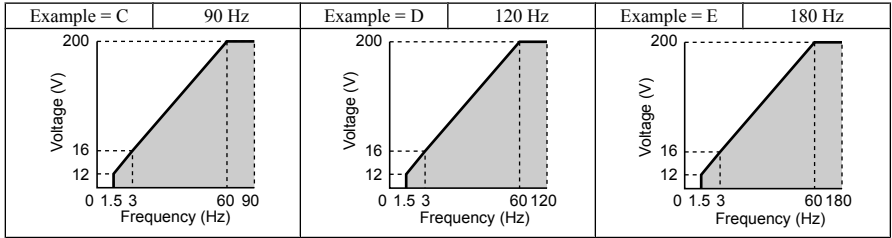

◆ **Motor Parameters: E2-01 to E2-03**

■ **Setting Motor Parameters**

The following table provides instructions on how to set motor parameters. Refer to the motor data sheet for the correct motor data.

No.	Parameter Name	Setting Method
E2-01	Motor Rated Current	Sets the motor nameplate full load current in amperes (A).
E2-02	Motor Rated Slip	Calculate and set the motor rated slip based on the rated speed described on the motor nameplate. Motor rated slip = Motor rated frequency [Hz] - Rated speed [r/min] x No. of motor poles / 120.
E2-03	Motor No-Load Current	Set motor no-load current at rated voltage and rated frequency. Contact the motor manufacturer to get the no-load current. This information is not usually written on the motor nameplate. The default no-load current is for a Yaskawa 4-pole motor.
E2-05	Motor Line-to-Line Resistance	Sets the phase-to-phase motor resistance in ohms.

◆ **Digital Output: H2-01**

Parameter H2-01 assigns functions to digital output terminals MA, MB, and MC. Set this parameter as required by the application. Default value is listed below.

NOTICE: Do not assign a function that repeats ON/OFF frequently to terminals MA and MB. Failure to comply will reduce the relay contact lifetime. The expected number of relay contact switching times is normally 200,000 times (current 1 A, resistance load).

No.	Parameter Name	Default
H2-01	Terminal MA, MB and MC Function Selection (relay)	E: Fault

Note: The setting range for H2-01 is 0 to 13D. Refer to [Parameter List on page 197](#) for more information.

4.5 Basic Operation

Multi-Function Contact Outputs
 250 Vac, 10 mA - 1 A
 30 Vdc, 10 mA - 1 A
 (standard default setting)

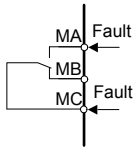

Figure 4.17 Digital Output Connection Diagram

◆ Analog Outputs: H4-01 to H4-03

Group U parameters can be used to observe the drive status (operating conditions) through the LED operator. Analog outputs corresponding to these monitors can be obtained on analog output terminal AM when programmed with parameter group H4. Some Group U monitors are not available as analog outputs.

No.	Parameter Name	Description
H4-01	Terminal AM Monitor Selection	Select the data to output through multi-function analog output terminal AM. Set the desired monitor parameter to the digits available in U□□□□. For example, enter “103” for U1-03. When using this terminal as a through terminal or when not using it at all, set “000” or “031”.
H4-02 </>	Terminal AM Output Gain	Sets the voltage level gain of terminal AM. The bias to be added ranges from 0 to +/- 10% when 10 V is assumed to be 100%.
H4-03 </>	Terminal AM Bias Setting	Sets the voltage level bias for terminal AM. The bias added is 0 to ±10% with a maximum voltage output of 10 V as 100%.

</> The parameter can be changed during run.

■ Changing Analog Output Settings

The following example illustrates how to program analog output terminal AM to generate a signal proportional to drive output current (monitor U1-03).

Using H4-01 to Display Monitor Contents

Step		Display/Result
1.	Turn on the power to the drive. The initial display appears.	→
2.	Press until the Parameter setting menu is displayed.	→
3.	Press to enter the Parameter setting menu.	→

Step		Display/Result
4.	Press and to select H4-01.	→
5.	Press to display the value currently set to H4-01.	→
6.	Press and to set the output current (103).	→
7.	Save the setting by pressing .	→
8.	The display automatically returns to the parameter setting menu.	→
9.	Press the key until back at the Top Screen.	→

Adjusting the Analog Output Terminal Voltage with H4-02 and H4-03

Note: This example continues from Step 3 in the previous example.

Step		Display/Result
1.	Select H4-02 or H4-03 by pressing the and keys.	→
2.	Press the key while the drive is stopped and the following voltage is output for adjustment: Output voltage = (10 V × Output Gain (H4-02) + Output Bias (H4-03)). Using this output, adjust output gain (H4-02) and output bias (H4-03).	→

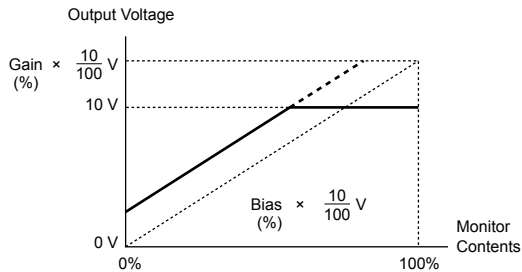

Figure 4.18 Analog Output Gain/Bias Setting

◆ Motor Protection: L1-01 and L1-02

This section explains how to set motor overload protection.

4.5 Basic Operation

■ Electronic Thermal Motor Protection

The drive has built-in electronic thermal overload protection to detect overload conditions. This protection meets standards set by UL and cUL for motor thermal overload protection. The protective feature is activated when the output current rises above the motor rated current for a specified time. This speed sensitive protective feature interrupts the motor current to protect the motor wiring and windings in the event of overload, eliminating the need for an external overload device. When multiple motors are used with a single drive, separate overload devices are required to properly protect the individual motor branches.

Related Parameters

No.	Parameter Name	Description	Setting Range	Default Setting
E2-01	Motor Rated Current	Sets the motor nameplate full load current in amperes (A). This set value becomes the reference value for motor protection, torque limit, and torque control.	10 to 200% of drive rated current	Determined by o2-04 and C6-01
L1-01	Motor Overload Protection Selection	Enables or disables motor thermal overload protection (oL1) 0: Disabled 1: Protection for general purpose motor 2: Protection for inverter motor	0 to 2 Use L1-13 (Continuous Electrothermal Operation Selection) to select whether electronic thermal value is “held” or “not held” when the power supply is turned off. When connecting several motors to one drive, set “0” (disabled) and install a thermal relay on each motor.	1
L1-02	Motor Overload Protection Time	Sets the electronic thermal overload protection detection time in the motor overload protection (oL1) function. This setting rarely needs to be changed and should be set in accordance with the overload tolerance of the motor.	0.1 to 5.0	1.0 min

Note: Executing C6-01 (Duty Cycle) changes motor parameters E2 including motor rated current to the values of the maximum applicable motor.

Setting Procedure

1. Set E2-01 (Motor Rated Current) to the motor rated current.

Values set for the current become the base current for electronic thermal overload protection.

2. Set the proper motor protection level to L1-01.

The ability of the cooling fan to keep an induction motor cool varies by the speed control range. Protection characteristics of the electronic thermal overload protection should be set accordingly. Refer to [Table 4.7](#) for motor types and overload tolerances.

NOTICE: When connecting multiple motors to one drive, disable the electronic overload protection of the drive (L1-01 = 0) and protect each motor with its own motor thermal overload. Failure to comply could result in improper drive operation.

NOTICE: Inadequate motor protection could result in damage to the motor. Configure a motor thermal overload to disconnect main power to the drive when tripped. When using a thermal relay, disable the motor protection function (L1-01 = “0”).

Table 4.7 Motor Type and Overload Tolerances

L1-01 Setting	Motor Type	Overload Tolerance	Cooling Fan Capacity	Electrothermal Protection (100% motor overload)
1	General-purpose motor (standard motor)		General purpose motors are designed to operate from line power. The most effective cooling occurs when running at line power specifications.	Operating continuously at less than line power frequency can trigger motor overload protection (oL1). A fault is then output and the motor will coast to stop.
2	Inverter Duty motor (1:10)		Motor designed to effectively self-cool at speeds as low as 6 Hz.	Continuous operation between 6 and 50/60 Hz.

Notes on Motor Protection

- Motor protection meeting UL and cUL standards is achieved with the motor overload protection time (L1-02) set to factory default setting. Normally, L1-02 (Motor Overload Protection Time) does not require setting. If the motor overload tolerance is clear, set the overload protection time at hot start according to the motor. To detect overload earlier, decrease the setting.

Figure 4.19 illustrates motor protection operation time characteristics.

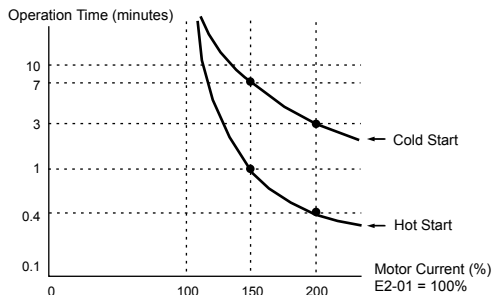

Figure 4.19 Motor Protection Operation

4.5 Basic Operation

- Disable motor protection (L1-01 = 1) when running multiple motors from the same drive. Attach a thermal relay for each motor to provide overload protection.
- Use L1-13 (Continuous Electrothermal Operation Selection) to select whether the electrothermal value is “held” or “not held” when power supply is turned off. Default setting is 1 (Enabled).
- In the case of a general purpose (standard) motor, the cooling capability is reduced at a low speed. Motor overload protection (oL1) may occur in frequencies lower than motor rated current. Use an exclusive-use or inverter-duty motor to operate the drive at rated current at low frequency.

◆ Notes on Controlling the Brake for the Hoist Application

- The frequency detection function is used for controlling the brake. When an external Baseblock command is present while a Run command is active, the frequency reference will be kept as long as the Run command is active. To avoid improper brake operation make sure that frequency detection is set so that the brake does not open during Baseblock (L4-07 = “0”, default).

Brake Open/Close		Brake Activation Level	
Function	Parameter	Signal	Parameter
Frequency Detection Conditions	L4-07 = 0	Frequency Detection Level	L4-01 = 2.0 to 3.0 Hz < >
Frequency Detection 2	H2-01 = 5	Frequency Detection Width	2.0 Hz (fixed)

<|> If the load slips during stop, make it greater than E1-09 or 2.0 Hz until the load no longer slips.

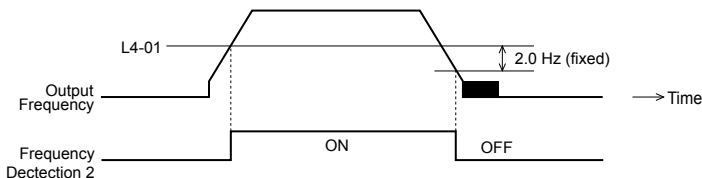

Figure 4.20 Frequency Detection 2

- The braking sequence should be designed as follows:
 - A normally open signal (N.O.) should be used to control the brake so that it is released when terminal MA-MC closes.
 - When an Up or Down command is entered, the brake should release.
 - When a fault signal is output, the brake should close.
- When changing the speed using an analog signal, make sure that the source of the frequency reference is assigned to the control circuit terminals (b1-01 = 1).

- A sequence to open and close the holding brake appears in the diagram below.

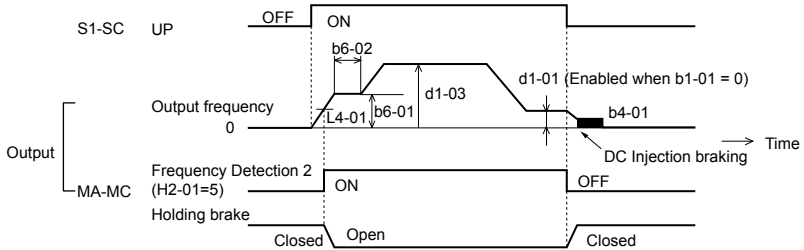

Figure 4.21 Holding Brake Time Chart

◆ Drive Status Monitors: U1-01 to U4-13

Parameter group U displays various data regarding the operating status of the drive. The following example demonstrates viewing output voltage reference (U1-06).

Step		Display/Result
1.	Turn on the power to the drive. The initial display appears.	
2.	Press until "Monitor Display" appears.	
3.	Press to enter the Parameter Setting Screen.	
4.	Press until U1-06 appears.	
5.	Press to display the voltage reference. The Output Voltage Reference appears.	

Refer to [Parameter List on page 197](#) for more details about Drive Status Monitors.

Table 4.8 Drive Status Monitors

No.	Parameter Name	Page	No.	Parameter Name	Page
U1-01	Frequency Reference	216	U1-13	Terminal A1 Input Voltage	217
U1-02	Output Frequency	216	U1-19	MEMOBUS/Modbus Error Code	217
U1-03	Output Current	216	U1-25	Software Number (ROM)	217
U1-06	Output Voltage Reference	216	U1-26	Software Number (Flash)	217
U1-07	DC Bus Voltage	216	U2-01	Current Fault	217
U1-10	Input Terminal Status	216	U2-02	Previous Fault	217
U1-11	Output Terminal Status	216	U4-01	Accumulated Operation Time	217

4.5 Basic Operation

No.	Parameter Name	Page
U4-04	Cooling Fan Maintenance	217
U4-05	Capacitor Maintenance	218
U4-07	IGBT Maintenance	218

No.	Parameter Name	Page
U4-08	Heatsink Temperature	218
U4-09	LED Check	218
U4-13	Peak Hold Current	218

4.6 Powering Up the Drive

◆ Powering Up the Drive and Operation Status Display



■ Powering Up the Drive

Review the following checklist before turning the power on.

Item to Check	Description
Power supply voltage	<p>Ensure the power supply voltage is correct: 200 V class: single-phase 200 to 240 Vac 50/60 Hz 200 V class: 3-phase 200 to 240 Vac 50/60 Hz 400 V class: 3-phase 380 to 480 Vac 50/60 Hz</p> <p>Properly wire the power supply input terminals (R/L1, S/L2, T/L3). (for single-phase 200 V class models, wire only R/L1 and S/L2)</p> <p>Check for proper <u>grounding</u> of drive and motor.</p>
Drive output terminals and motor terminals	Properly wire drive output terminals U/T1, V/T2, and W/T3 with motor terminals U, V, and W.
Control circuit terminals	Check control circuit terminal connections.
Drive control terminal status	Open all control circuit terminals (off).
Status of the load and connected machinery	Uncouple the motor from the load.

■ Status Display

When the power supply to the drive is turned on, the LED operator lights will appear as follows:

No.	Name	Description
Normal Operation		The data display area displays the frequency reference. [DRV] is lit.
Fault	 Main circuit low voltage (ex)	Data displayed varies by the type of fault. <i>Refer to Fault Displays, Causes, and Possible Solutions on page 126</i> for more information and possible solution. [ALM] and [DRV] are lit.

◆ V/f Pattern Setting

Setting the V/f pattern according to the application. *Refer to Instructions for Setting a V/f Pattern on page 100* for details on setting the V/f pattern.

■ Notes when Setting the V/f Pattern.

Set the maximum output frequency to match the motor characteristics.

4.6 Powering Up the Drive

If the V/f pattern voltage is increased motor torque may also increase. However, if the V/f voltage is set too high these problems may occur:

- Excessive motor current.
- Motor overheat or vibration.

4.7 No-Load Operation Test Run

◆ No-Load Operation Test Run

This section explains how to operate the drive with the motor uncoupled from the load during a test run.

■ Before Starting the Motor

Check the following items before operation:

- Ensure the area around the motor is safe.
- Ensure external emergency stop circuitry is working properly and other safety precautions have been taken.

■ During Operation



Check the following items during operation:

- The motor should rotate smoothly (i.e., no abnormal noise or oscillation).
- The motor should accelerate and decelerate smoothly.







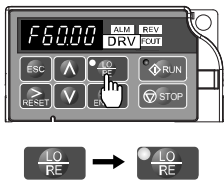



■ No-Load Operation Instructions

The following example illustrates a test run procedure using the digital operator.

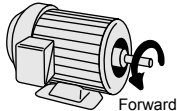
Note: Before starting the motor, set the frequency reference d1-01 to 6 Hz.

Step		Display/Result
1.	Turn on the power to the drive. The initial display appears.	
2.	Press the  key to select LOCAL. The LO/RE LED will turn on.	

4.7 No-Load Operation Test Run

Step		Display/Result
3.	Press  to give the drive a Run command. RUN will light and the motor will rotate at 6 Hz.	  Off →  On
4.	Ensure the motor is rotating in the correct direction and no faults or alarms occur.	 Motor Forward
5.	If there is no error in step 4, press  to increase the frequency reference. Increase the frequency in 10 Hz increments verifying smooth operation results at all speeds. For each frequency, monitor the drive output current (U1-03) through the LED operator to confirm the current is well below the motor rated current. Example: 6 Hz → 60 Hz.	
6.	The drive should operate normally. Press  to stop the motor. RUN flashes until the motor comes to a complete stop.	  Flashing →  Off

4.8 Test Run with Load Connected

◆ Test Run with the Load Connected

After performing a no-load test run connect the motor and proceed to run the motor and load together.

■ Notes on Connected Machinery

- Clear the area around the motor.
- The motor should come to a complete stop without problems.
- Connect the machinery.
- Fasten all installation screws properly. Check that the motor and connected machinery are held in place.
- Confirm that the Fast-stop circuit or mechanical safety measures operate correctly.
- Be ready to press the STOP button in case of emergency.

■ Checklist Before Operation

- The motor should rotate in the proper direction.
- The motor should accelerate and decelerate smoothly.

■ Operating the Motor under Loaded Conditions

Test run the application similarly to the no-load test procedure when connecting the machinery to the motor.

- Check monitor parameter U1-03 to ensure there is no overcurrent.
- If the application permits running the load in the reverse direction, try changing motor direction and the frequency reference while watching for abnormal motor oscillation or vibration.
- Correct any problems that occurs with hunting, oscillation, or other control-related issues.

4.9 Verifying and Backing Up Parameter Settings

Check changes to parameter settings using the Verify function. *Refer to Verifying Parameter Changes: Verify Menu on page 83.*

Save the verified parameter settings. Change the access level or set a password to the drive to prevent accidental modification of parameter settings.



◆ Parameter Access Level: A1-01

Setting the Access Level for “Operation only” (A1-01 = 0) allows the user to access parameters A1-□□ and U□-□□ only. Other parameters are not displayed.

No.	Parameter Name	Description	Setting Range	Default
A1-01	Access Level Selection	Selects which parameters are accessible via the digital operator. 0: Operation only (A1-01 and A1-04 can be set and monitored. U parameters can be monitored) 2: Advanced Access Level (All parameters can be set and monitored)	0,2	2

◆ Password Settings: A1-04, A1-05

The user can set a password to the drive to restrict access. The password is selected via parameter A1-05. The selected password must be entered in parameter A1-04 to unlock parameter access (i.e., parameter setting A1-04 must match the value programmed into A1-05). The following parameters cannot be viewed or edited until the value programmed into A1-04 correctly matches the value as programmed in parameter A1-05: A1-01, A1-02, and A1-03.

Note: Parameter A1-05 is hidden from view. To display A1-05, access parameter A1-04 and simultaneously depress the  key and the  key.



Troubleshooting

This chapter provides descriptions of the drive faults, alarms, errors, related displays, and possible solutions. This chapter can also serve as a reference guide for tuning the drive during a trial run.

5.1	SECTION SAFETY.....	118
5.2	MOTOR PERFORMANCE FINE TUNING.....	121
5.3	DRIVE ALARMS, FAULTS, AND ERRORS.....	123
5.4	FAULT DETECTION.....	126
5.5	ALARM DETECTION.....	134
5.6	OPERATOR PROGRAMMING ERRORS.....	139
5.7	DIAGNOSING AND RESETTING FAULTS.....	141
5.8	TROUBLESHOOTING WITHOUT FAULT DISPLAY.....	143

5.1 Section Safety

DANGER

Electrical Shock Hazard

Do not connect or disconnect wiring while the power is on.

Failure to comply will result in death or serious injury.

WARNING

Electrical Shock Hazard

Do not operate equipment with covers removed.

Failure to comply could result in death or serious injury.

The diagrams in this section may illustrate drives without covers or safety shields to display details. Be sure to reinstall covers or shields before operating the drives and run the drives according to the instructions described in this manual.

Always ground the motor-side grounding terminal.

Improper equipment grounding could result in death or serious injury by contacting the motor case.

Do not touch terminals before the capacitors have fully discharged.

Failure to comply could result in death or serious injury.

Before wiring terminals, disconnect all power to the equipment. The internal capacitor remains charged even after the drive input power is turned off. The charge indicator LED will extinguish when the DC bus voltage is below 50 Vdc. To prevent electric shock, wait at least one minute after all indicators are off and measure the DC bus voltage level to confirm safe level.

Do not allow unqualified personnel to perform work on the drive.

Failure to comply could result in death or serious injury.

Installation, maintenance, inspection and servicing must be performed only by authorized personnel familiar with installation, adjustment and maintenance of AC drives.

 **WARNING**

Do not perform work on the drive while wearing loose clothing, jewelry, or without eye protection.

Failure to comply could result in death or serious injury.

Remove all metal objects such as watches and rings, secure loose clothing and wear eye protection before beginning work on the drive.

Do not remove covers or touch circuit boards while the power is on.

Failure to comply could result in death or serious injury.

Fire Hazard

Tighten all terminal screws to the specified tightening torque.

Loose electrical connections could result in death or serious injury by fire due to overheating of electrical connections.

Do not use an improper voltage source.

Failure to comply could result in death or serious injury by fire.

Verify that the rated voltage of the drive matches the voltage of the incoming drive input power before applying power.

Do not use improper combustible materials.

Failure to comply could result in death or serious injury by fire.

Attach the drive to metal or other noncombustible material.

NOTICE

Observe proper electrostatic discharge procedures (ESD) when handling the drive and circuit boards.

Failure to comply may result in ESD damage to the drive circuitry.

Never connect or disconnect the motor from the drive while the drive is outputting voltage.

Improper equipment sequencing could result in damage to the drive.

Do not use unshielded cable for control wiring.

Failure to comply may cause electrical interference resulting in poor system performance. Use shielded twisted-pair wires and ground the shield to the ground terminal of the drive.

Do not allow unqualified personnel to use the product.

Failure to comply could result in damage to the drive or braking circuit.

Carefully review instruction manual TOBPC72060000 when connecting a braking option to the drive.

Do not modify the drive circuitry.

Failure to comply could result in damage to the drive and will void warranty.

Yaskawa is not responsible for modification of the product made by the user.

Check all the wiring after installing the drive and connecting other devices to ensure that all connections are correct.

Failure to comply could result in damage to the drive.

5.2 Motor Performance Fine Tuning

This section offers helpful information for counteracting oscillation, hunting, or other faults that occur while performing a trial run.

Note: This section describes parameters that are commonly edited. Consult Yaskawa for more information on detailed settings and fine-tuning the drive.

◆ Parameters for Tuning the Drive

Table 5.1 Parameters for Tuning the Drive

Problem	Parameter No.	Corrective Action	Default Value	Suggested Setting
<ul style="list-style-type: none"> Motor hunting and oscillation at speeds between 10 and 40 Hz 	Hunting Prevention Gain (n1-02)	<ul style="list-style-type: none"> If insufficient motor torque relative to the size of the load causes hunting, reduce the setting. When motor hunting and oscillation occur with a light load, increase the setting. Lower this setting if hunting occurs when using a motor with a relatively low inductance, such as a high-frequency motor or a motor with a larger frame size. 	1.00	0.10 to 2.00
<ul style="list-style-type: none"> Motor noise Motor hunting and oscillation at speeds up to 40 Hz 	Carrier Frequency Selection (C6-02)	<ul style="list-style-type: none"> If the motor noise is too loud, increase the carrier frequency. When motor hunting and oscillation occur at speeds up to 40 Hz, lower the carrier frequency. The default setting for the carrier frequency depends on the drive capacity (o2-04) and the Drive Duty Selection (C6-01). 	7 (Swing PWM)	1 to 7
<ul style="list-style-type: none"> Poor motor torque at speeds below 10 Hz Motor hunting and oscillation 	Torque Compensation Gain (C4-01)	<ul style="list-style-type: none"> If motor torque is insufficient at speeds below 10 Hz, increase the setting. If motor hunting and oscillation with a relatively light load, decrease the setting. 	1.00	0.50 to 1.50
<ul style="list-style-type: none"> Poor motor torque at low speeds Motor instability at motor start 	Mid Output Voltage A (E1-08) Minimum Output Voltage (E1-10)	<ul style="list-style-type: none"> If torque is insufficient at speeds below 10 Hz, increase the setting. If motor instability occurs at motor start, decrease the setting. <p>Note: The recommended setting value is for 200 V class drives. Double this value when using a 400 V class drive.</p>	E1-08: 16.0 V E1-10: 12.0 V	Initial value ±5 V
<ul style="list-style-type: none"> Poor speed precision 	Slip Compensation Gain (C3-01)	<ul style="list-style-type: none"> After setting the motor-rated current (E2-01), motor-rated slip (E2-02) and motor no-load current (E2-03), adjust the slip compensation gain (C3-01). 	-	0.5 to 1.5

◆ Motor Hunting and Oscillation Control Parameters

The following parameters indirectly affect motor hunting and oscillation.

5.2 Motor Performance Fine Tuning

Table 5.2 Parameters that Affect Control Performance in Applications

Name (Parameter No.)	Application
Accel/Decel Time (C1-01 through C1-04; C1-09)	Adjusting accel and decel times will affect the torque presented to the motor during acceleration or deceleration.
S-Curve Characteristics (C2-01 through C2-04)	Prevents shock at the beginning and end of acceleration and deceleration.
Jump Frequency (d3-01 through d3-04)	Skips over the resonant frequencies of connected machinery.
Analog Filter Time Constant (H3-13)	Prevents fluctuation in the analog input signal due to noise.
Stall Prevention (L3-01 through L3-06)	<ul style="list-style-type: none">• Prevents motor speed loss and overvoltage. Used when the load is too heavy and also during sudden acceleration/deceleration.• Adjustment is not normally required because Stall Prevention is enabled as a default. Disable Stall Prevention during deceleration (L3-04 = "0") when using a braking resistor.

5.3 Drive Alarms, Faults, and Errors

◆ Types of Alarms, Faults, and Errors

Check the LED operator for information about possible faults if the drive or motor fails to operate. *Refer to Using the Digital LED Operator on page 73.*

If problems occur that are not covered in this manual, contact the nearest Yaskawa representative with the following information:

- Drive model
- Software version
- Date of purchase
- Description of the problem

Table 5.3 contains descriptions of the various types of alarms, faults, and errors that may occur while operating the drive.

Contact Yaskawa in the event of drive failure.

Table 5.3 Types of Alarms, Faults, and Errors

Type	Drive Responses to Alarms, Faults, and Errors
Faults	<p>When the drive detects a fault:</p> <ul style="list-style-type: none"> • The digital operator displays text that indicates the specific fault and the ALM indicator LED remains lit until the fault is reset. • The fault interrupts drive output and the motor coasts to a stop. • Depending on the setting, the drive and motor may stop via different methods than listed. • If a digital output is programmed for fault output (H2-01 = E), it will close if a fault occurs. <p>When the drive detects a fault, it will remain inoperable until that fault has been reset. <i>Refer to Fault Reset Methods on page 142.</i></p>
Minor Faults and Alarms	<p>When the drive detects an alarm or a minor fault:</p> <ul style="list-style-type: none"> • The digital operator displays text that indicates the specific alarm or minor fault and the ALM indicator LED flashes. • The motor does not stop. • The multi-function contact output closes if set to be tripped by a minor fault (H2-01 = 10), but not by an alarm. • The digital operator displays text indicating a specific alarm and ALM indicator LED flashes. Remove the cause of an alarm or minor fault to automatically reset.
Operation Errors	<p>When parameter settings conflict with one another or do not match hardware settings (such as with an option unit), it results in an operation error.</p> <p>When the drive detects an operation error:</p> <ul style="list-style-type: none"> • The digital operator displays text that indicates the specific error. • The multi-function contact output does not operate. <p>When the drive detects an operation error, it will not operate the motor until the error has been reset. Correct the settings that caused the operation error to reset.</p>

5.3 Drive Alarms, Faults, and Errors

◆ Alarm and Error Displays

■ Faults

When the drive detects a fault, the ALM indicator LEDs remain lit without flashing. If the LEDs flash, the drive has detected a minor fault or alarm. [Refer to Minor Faults and Alarms on page 124](#) for more information. Conditions such as overvoltage or external faults can trip both faults and minor faults, therefore it is important to note whether the LEDs remain lit or if the LEDs flash.

LED Operator Display	Name	Page
CE	MEMOBUS/Modbus Communication Error	126
CoF	Current Offset Fault	126
CPF02	A/D Conversion Error	126
CPF06	Drive specification mismatch during Terminal Board or Control Board replacement	126
CPF08	EEPROM Serial Communications Fault	126
CPF11	RAM Fault	127
CPF12	FLASH Memory Fault	127
CPF14	Control Circuit Fault	127
CPF17	Timing Fault	127
CPF18	Control Circuit Fault	127
CPF20 or CPF21	RAM Fault	127
	FLASH Memory Fault	127
	Watchdog Circuit Exception	127
	Clock Fault	127

LED Operator Display	Name	Page
oL1	Motor Overload	130
oL2	Drive Overload	130
oL3	Overtorque Detection 1	131
oPr	Operator Connection Fault	131
CPF22	A/D Conversion Error	127
CPF23	PWM Feedback Data Fault	127
CPF24	Drive Capacity Signal Fault	128
EF0	Option Unit External Fault	128
EF1 to EF5	External Fault (input terminal S1 to S5)	128
oC	Overcurrent	128
oH1	Heatsink Overheat	129
Err	EEPROM Write Error	128
Uv1	Undervoltage	133
Uv3	Soft Charge Circuit Fault	133
ov	Overvoltage	136
PF	Input Phase Loss	132

<1> Displayed as CPF00 when occurring at drive power up. When one of the faults occurs after successfully starting the drive, the display will show CPF01

■ Minor Faults and Alarms

When a minor fault or alarm occurs, the ALM LED flashes and the text display shows an alarm code. A fault has occurred if the text remains lit and does not flash. [Refer to Alarm Detection on page 134](#). An overvoltage situation, for example, can trigger both faults and minor faults. It is therefore important to note whether the LEDs remain lit or if the LEDs flash.

Table 5.4 Minor Fault and Alarm Displays

LED Operator Display		Name	Minor Fault Output (H2-01 = 10)	Page
<i>bb</i>	bb	Drive Baseblock	No output	134
<i>CALL</i>	CALL	Serial Communication Transmission Error	YES	134
<i>CE</i>	CE	MEMOBUS/Modbus Communication Error	YES	134
<i>CrSt</i>	CrST	Can Not Reset	YES	135
<i>EF</i>	EF	Run Command Input Error	YES	135
<i>EF1 to EF5</i>	EF1 to EF5	External Fault (input terminal S1 to S5)	YES	135
<i>SE</i>	SE	MEMOBUS/Modbus Test Mode Fault	YES	137
<i>oH</i>	oH	Heatsink Overheat	YES	136
<i>oL3</i>	oL3	Overtorque 1	YES	136
<i>ov</i>	ov	Overvoltage	YES	136
<i>PASS</i>	PASS	MEMOBUS/Modbus Test Mode Complete	No output	137
<i>Uv</i>	Uv	Undervoltage	YES	137

■ Operation Errors





Table 5.5 Operation Error Displays









LED Operator Display	Name	Page	LED Operator Display	Name	Page		
<i>oPE01</i>	oPE01	Drive Unit Setting Error	139	<i>oPE05</i>	oPE05	Run Command Selection Error	140
<i>oPE02</i>	oPE02	Parameter Setting Range Error	139	<i>oPE10</i>	oPE10	V/f Data Setting Error	140
<i>oPE03</i>	oPE03	Multi-Function Input Setting Error	139	<i>oPE11</i>	oPE11	Carrier Frequency Setting Error	140

5.4 Fault Detection











◆ Fault Displays, Causes, and Possible Solutions

Table 5.6 Detailed Fault Displays, Causes, and Possible Solutions

LED Operator Display		Fault Name
	CE	MEMOBUS/Modbus Communication Error
		Control data was not received for the CE detection time set to H5-09.
Cause		Possible Solution
Faulty communications wiring, or a short circuit exists.		<ul style="list-style-type: none"> • Check for faulty wiring. • Correct the wiring. • Check for loose wiring and short circuits. Repair as needed.
A communications data error occurred due to noise.		<ul style="list-style-type: none"> • Check the various options available to minimize the effects of noise. • Counteract noise in control circuit, main circuit, and ground wiring. • Use Yaskawa-recommended cables, or another type of shielded line. Ground the shield on the controller side or on the drive input power side. • Ensure that other equipment such as switches or relays do not cause noise and use surge suppressors if required. • Separate all wiring for communications devices from drive input power lines. Install a noise filter to the input side of the drive input power.
LED Operator Display		Fault Name
	CoF	Current Offset Fault
		There is a problem with the current detection circuit.
Cause		Possible Solution
Drive hardware is damaged.		Replace the drive.
LED Operator Display		Fault Name
	CPF02	A/D Conversion Error
		An A/D conversion error occurred.
Cause		Possible Solution
Control circuit is damaged.		Cycle power to the drive. If the problem continues, replace the drive.
Control circuit terminals have shorted out (+V, AC).		<ul style="list-style-type: none"> • Check for wiring errors along the control circuit terminals. • Correct the wiring.
Control terminal input current has exceeded allowable levels.		<ul style="list-style-type: none"> • Check the input current. • Reduce the current input to control circuit terminal (+V) to 20 mA.
Check the resistance of the speed potentiometer and related wiring.		
LED Operator Display		Fault Name
	CPF06	EEPROM Data Error
		There is an error in the data saved to EEPROM.
Cause		Possible Solution
Control circuit is damaged.		Cycle power to the drive. If the problem continues, replace the drive.
The power supply was switched off when parameters were written (e.g., using an option unit).		Reinitialize the drive (A1-03).
LED Operator Display		Fault Name
	CPF08	EEPROM Communication Fault
		EEPROM communications are not functioning properly.

Cause		Possible Solution
Control circuit is damaged.		Cycle power to the drive. If the problem persists, replace the drive.
LED Operator Display		Fault Name
	CPF11	RAM Fault
Cause		Possible Solution
Hardware is damaged.		Replace the drive.
LED Operator Display		Fault Name
	CPF12	FLASH Memory Fault Problem with the ROM (FLASH memory).
Cause		Possible Solution
Hardware is damaged.		Replace the drive.
LED Operator Display		Fault Name
	CPF14	Control Circuit Fault CPU error (CPU operates incorrectly due to noise, etc.)
Cause		Possible Solution
Hardware is damaged.		Replace the drive.
LED Operator Display		Fault Name
	CPF17	Timing Fault A timing error occurred during an internal process.
Cause		Possible Solution
Hardware is damaged.		Replace the drive.
LED Operator Display		Fault Name
	CPF18	Control Circuit Fault CPU error (CPU operates incorrectly due to noise, etc.)
Cause		Possible Solution
Hardware is damaged.		Replace the drive.
LED Operator Display		Fault Name
	CPF20 or CPF21	One of the following faults occurred: RAM fault, FLASH memory error, watchdog circuit exception, clock error <ul style="list-style-type: none"> • RAM fault. • FLASH memory error (ROM error). • Watchdog circuit exception (self-diagnostic error). • Clock error.
Cause		Possible Solution
Hardware is damaged.		Replace the drive.
LED Operator Display		Fault Name
	CPF22	A/D Conversion Fault A/D conversion error.
Cause		Possible Solution
Control circuit is damaged.		<ul style="list-style-type: none"> • Cycle power to the drive. <i>Refer to Diagnosing and Resetting Faults on page 141.</i> • If the problem continues, replace the drive.
LED Operator Display		Fault Name
	CPF23	PWM Feedback Fault PWM feedback error.



5.4 Fault Detection

Cause		Possible Solution
Hardware is damaged.		Replace the drive.
LED Operator Display		Fault Name
	CPF24	Drive Capacity Signal Fault Entered a capacity that does not exist. (Checked when the drive is powered up.)
Cause		Possible Solution
Hardware is damaged.		Replace the drive.
LED Operator Display		Fault Name
	EF0	Option Unit External Fault An external fault condition is present.
Cause		Possible Solution
An external fault was received from the PLC.		<ul style="list-style-type: none"> Remove the cause of the external fault. Remove the external fault input from the PLC.
Problem with the PLC program.		Check the PLC program and correct problems.
LED Operator Display		Fault Name
	EF1	External Fault (input terminal S1) External fault at multi-function input terminal S1.
	EF2	External Fault (input terminal S2) External fault at multi-function input terminal S2.
	EF3	External Fault (input terminal S3) External fault at multi-function input terminal S3.
	EF4	External Fault (input terminal S4) External fault at multi-function input terminal S4.
	EF5	External Fault (input terminal S5) External fault at multi-function input terminal S5.
Cause		Possible Solution
An external device has tripped an alarm function.		Remove the cause of the external fault and reset the fault.
Wiring is incorrect.		<ul style="list-style-type: none"> Ensure the signal lines have been connected properly to the terminals assigned for external fault detection (H1-□□ = 20 to 2F). Reconnect the signal line.
Incorrect setting of multi-function contact inputs.		<ul style="list-style-type: none"> Check if the unused terminals set for H1-□□ = 20 to 2F (External Fault). Change the terminal settings.
LED Operator Display		Fault Name
	Err	EEPROM Write Error Data does not match the EEPROM being written to.
Cause		Possible Solution
-		<ul style="list-style-type: none"> Press the  button. Correct the parameter settings. Cycle power to the drive. <i>Refer to Diagnosing and Resetting Faults on page 141.</i>
LED Operator Display		Fault Name
	oC	Overcurrent Drive sensors have detected an output current greater than the specified overcurrent level.

Cause	Possible Solution
The motor has been damaged due to overheating or the motor insulation is damaged.	<ul style="list-style-type: none"> • Check the insulation resistance. • Replace the motor.
One of the motor cables has shorted out or there is a grounding problem.	<ul style="list-style-type: none"> • Check the motor cables. • Remove the short circuit and power the drive back up. • Check the resistance between the motor cables and the ground terminal(⊕). • Replace damaged cables.
The load is too heavy.	<ul style="list-style-type: none"> • Measure the current flowing into the motor. • Replace the drive with a larger capacity unit if the current value exceeds the rated current of the drive. • Determine if there is sudden fluctuation in the current level. • Reduce the load to avoid sudden changes in the current level or switch to a larger drive.
The acceleration or deceleration times are too short.	<p>Calculate the torque needed during acceleration relative to the load inertia and the specified acceleration time.</p> <p>If the right amount of torque cannot be set, make the following changes:</p> <ul style="list-style-type: none"> • Increase the acceleration time (C1-01, -03) • Increase the S-curve characteristics (C2-01 through C2-04) • Increase the capacity of the drive.
The drive is attempting to operate a specialized motor or a motor larger than the maximum size allowed.	<ul style="list-style-type: none"> • Check the motor capacity. • Ensure that the rated capacity of the drive is greater than or equal to the capacity rating found on the motor nameplate.
Magnetic contactor (MC) on the output side of the drive has turned on or off.	Set up the operation sequence so that the MC is not tripped while the drive is outputting current.
V/f setting is not operating as expected.	<ul style="list-style-type: none"> • Check the ratios between the voltage and frequency. • Set parameter E1-04 through E1-10 appropriately. • Lower the voltage if it is too high relative to the frequency.
Excessive torque compensation.	<ul style="list-style-type: none"> • Check the amount of torque compensation. • Reduce the torque compensation gain (C4-01) until there is no speed loss and less current.
Drive fails to operate properly due to noise interference.	<ul style="list-style-type: none"> • Review the possible solutions provided for handling noise interference. • Review the section on handling noise interference and check the control circuit lines, main circuit lines and ground wiring.
Overexcitation gain is set too high.	<ul style="list-style-type: none"> • Check if fault occurs simultaneously to overexcitation function operation. • Consider motor flux saturation and reduce the value of n3-13 (Overexcitation Deceleration Gain).
Run command applied while motor was coasting.	<ul style="list-style-type: none"> • Program the Speed Search command input through one of the multi-function contact input terminals (H1-□□ = “61” or “62”).
The motor cable is too long	Use a larger drive.
LED Operator Display	Fault Name
<i>oFA01</i>	oFA01
	Option Unit Fault
	Replace the option unit.
Cause	Possible Solution
The option unit is not properly connected to the drive.	Turn the power off and reconnect the option unit.
LED Operator Display	Fault Name
<i>oH1</i>	oH1
	Overheat 1 (Heatsink Overheat)
	The temperature of the heatsink has exceeded 100-110 °C. The value is determined by drive capacity (o2-04).

5.4 Fault Detection



Cause	Possible Solution
Surrounding temperature is too hot.	<ul style="list-style-type: none"> Check the temperature surrounding the drive. Improve the air circulation within the enclosure panel. Install a fan or air conditioner to cool the surrounding area. Remove anything near the drive that might be producing excessive heat.
Load is too heavy.	<ul style="list-style-type: none"> Measure the output current. Lower the carrier frequency (C6-02). Reduce the load.
Current flowing to control circuit terminal +V exceeded the tolerance level.	<ul style="list-style-type: none"> Check the current level of the terminal. Set the current to the control circuit terminal to be 20 mA or less.

LED Operator Display		Fault Name
	oL1	Motor Overload
		The electrothermal sensor tripped overload protection.
Cause		Possible Solution
Load is too heavy.		Reduce the load.
Cycle times are too short during acceleration and deceleration.		Increase the acceleration and deceleration times (C1-01 through C1-04).
<ul style="list-style-type: none"> Drive overloaded at low speeds. Overload may occur at low speeds when using a general-purpose motor, even if operating within the rated current limitation. 		<ul style="list-style-type: none"> Reduce the load. Increase the speed. If the drive is supposed to operate at low speeds, either increase the motor capacity or use a motor specifically designed to operate with the drive.
Although a special type of motor is being used, the motor protection selection is set for a general-purpose motor (L1-01 = 1).		Set L1-01 = "2".
Voltage is too high for the V/f characteristics.		<ul style="list-style-type: none"> Adjust the user set V/f patterns (E1-04 through E1-10). Parameters E1-08 and E1-10 may need to be reduced. If E1-08 and E1-10 are set too high, there may be very little load tolerance at low speed.
The wrong motor-rated current is set to E2-01.		<ul style="list-style-type: none"> Check the motor-rated current. Enter the value written on the motor nameplate to parameter E2-01.
The maximum frequency for the drive input power is set too low.		<ul style="list-style-type: none"> Check the rated frequency indicated on the motor nameplate. Enter the rated frequency to E1-06 (Base Frequency).
Multiple motors are running off the same drive.		Disable the Motor Protection function (L1-01 = "0") and install a thermal relay to each motor.
The electrical thermal protection characteristics and motor overload characteristics do not match.		<ul style="list-style-type: none"> Check the motor characteristics. Correct the value set to L1-01 (Motor Protection Function). Install an external thermal relay.
The electrical thermal relay is operating at the wrong level.		<ul style="list-style-type: none"> Check the current rating listed on the motor nameplate. Check the value set for the motor-rated current (E2-01).
Overexcitation current is enabled.		<ul style="list-style-type: none"> Overexcitation is a potential serious danger to the motor. Reduce the excitation deceleration gain (n3-13). Set L3-04 (Stall Prevention during Deceleration) to a value other than 4.
Output current fluctuation due to input phase loss		Check the power supply for phase loss.
LED Operator Display		Fault Name
	oL2	Drive Overload
		The thermal sensor of the drive triggered overload protection.
Cause		Possible Solution

Load is too heavy.	Reduce the load.
Cycle times are too short during acceleration and deceleration.	Increase the settings for the acceleration and deceleration times (C1-01 through C1-04).
Voltage is too high for the V/f characteristics.	<ul style="list-style-type: none"> Adjust the preset V/f pattern (E1-04 through E1-10). This will mainly involve reducing E1-08 and E1-10. Be careful not to lower E1-08 and E1-10 excessively because this reduces load tolerance at low speeds.
Drive capacity is too small.	Replace the drive with a larger model.
Overload occurred when operating at low speeds.	<ul style="list-style-type: none"> Reduce the load when operating at low speeds. Replace the drive with a model that is one frame size larger. Lower the carrier frequency (C6-02).
Excessive torque compensation.	Reduce the torque compensation gain (C4-01) until there is no speed loss but less current.
Output current fluctuation due to input phase loss	Check the power supply for phase loss.
LED Operator Display	
oL3	oL3
Cause	Possible Solution
Parameter settings are not appropriate for the type of load.	Check the settings of parameters L6-02 and L6-03.
LED Operator Display	
oPr	oPr
Cause	Possible Solution
LCD operator is not properly connected to the drive.	<ul style="list-style-type: none"> Check the connection between the LCD operator and the drive Replace the cable if damaged Turn off the drive input power and disconnect the LCD operator. Next reconnect the operator and turn the drive input power back on.
LED Operator Display	
ov	ov
Cause	Possible Solution
Deceleration time is too short and regenerative energy flows from the motor into the drive.	<ul style="list-style-type: none"> Increase the deceleration time (C1-02, -04). Install a braking resistor or a dynamic braking resistor unit. Enable stall prevention during deceleration (L3-04 = "1"). Stall prevention is enabled as the default setting.
Excessive braking load.	The braking torque was too high, causing regenerative energy to charge the DC bus. Reduce the braking torque, use a braking option, or lengthen decel time.
Surge voltage entering from the drive input power.	Install a DC reactor. Note: Voltage surge can result from thyristor converter and phase advancing capacitor using same drive main input power supply.

5.4 Fault Detection

Ground fault in the output circuit causing the DC bus capacitor to overcharge.		<ul style="list-style-type: none"> • Check the motor wiring for ground faults. • Correct grounding shorts and turn the power back on.
Drive input power voltage is too high.		<ul style="list-style-type: none"> • Check the voltage. • Lower drive input power voltage within the limits listed in the specifications.
The dynamic braking transistor is damaged.		Replace the drive.
The braking transistor is wired incorrectly.		<ul style="list-style-type: none"> • Check braking transistor wiring for errors. • Properly rewire the braking resistor device.
Drive fails to operate properly due to noise interference.		<ul style="list-style-type: none"> • Review the list of possible solutions provided for controlling noise. • Review the section on handling noise interference and check the control circuit lines, main circuit lines and ground wiring.
Motor hunting occurs.		<ul style="list-style-type: none"> • Adjust the parameters that control hunting. • Set the hunting prevention gain (n1-02).
LED Operator Display		Fault Name
\overline{PF}	PF	Input Phase Loss
		Drive input power has an open phase or has a large imbalance of voltage between phases. Detected when L8-05 = 1 (enabled).
Cause		Possible Solution
There is phase loss in the drive input power.		<ul style="list-style-type: none"> • Check for wiring errors in the main circuit drive input power. • Correct the wiring.
There is loose wiring in the drive input power terminals.		<ul style="list-style-type: none"> • Ensure the terminals are tightened properly. • Apply the tightening torque specified in this manual to fasten the terminals. <i>Refer to Wire Gauges and Tightening Torque on page 50</i>
There is excessive fluctuation in the drive input power voltage.		<ul style="list-style-type: none"> • Check the voltage from the drive input power. • Review the possible solutions for stabilizing the drive input power. • Disable Input Phase Loss Detection (L8-05 = "0"). PF is detected if DC bus ripple is too high. If it is disabled, there is no fault but the ripple is still too high, thereby the capacitors are stressed more and lose lifetime.
There is poor balance between voltage phases.		<ul style="list-style-type: none"> • Stabilize drive input power or disable phase loss detection.
The main circuit capacitors are worn.		<ul style="list-style-type: none"> • Check the maintenance time for the capacitors (U4-05). • Replace the drive if U4-05 is greater than 90%. • Check for anything wrong with the drive input power. • If nothing is wrong with the drive input power, try the following solutions if the alarm continues: • Disable Input Phase Loss Protection selection (L8-05 = "0"). PF is detected if DC bus ripple is too high. If it is disabled, there is no fault but the ripple is still too high, thereby the capacitors are stressed more and lose lifetime. • Replace the drive.
LED Operator Display		Fault Name
\overline{rH}	rH	Braking Resistor Overheat
		Braking resistor protection was triggered. Fault detection is enabled when L8-01 = 1 (disabled as a default). Note: The magnitude of the braking load trips the braking resistor overheat alarm, NOT the surface temperature. Using the braking resistor more frequently than its rating trips the alarm even when the braking resistor surface is not very hot.
Cause		Possible Solution
Deceleration time is too short and excessive regenerative energy is flowing back into the drive.		<ul style="list-style-type: none"> • Check the load, deceleration time and speed. • Reduce the load. • Increase the acceleration and deceleration times (C1-01 through C1-04). • Replace the braking option with a larger device that can handle the power that is discharged.

Excessive braking inertia.		Recalculate braking load and braking power. Then try reducing the braking load and checking the braking resistor settings and improve braking capacity.
The proper braking resistor has not been installed.		<ul style="list-style-type: none"> • Check the specifications and conditions for the braking resistor device. • Select the optimal braking resistor.
LED Operator Display		Fault Name
	Uv1	DC Bus Undervoltage One of the following conditions occurred while the drive was stopped: <ul style="list-style-type: none"> • Voltage in the DC bus fell below the undervoltage detection level. • For 200 V class: approximately 190 V (160 V for single phase drives) • For 400 V class: approximately 380 V (350 V when E1-01 is less than 400) The fault is output only if L2-01 = 0 or L2-01 = 1 and the DC bus voltage is under L1-05 for longer than L2-02.
Cause		Possible Solution
Input power phase loss.		<ul style="list-style-type: none"> • The main circuit drive input power is wired incorrectly. • Correct the wiring.
One of the drive input power wiring terminals is loose.		<ul style="list-style-type: none"> • Ensure there are no loose terminals. • Apply the tightening torque specified in this manual to fasten the terminals. <i>Refer to Wire Gauges and Tightening Torque on page 50</i>
There is a problem with the voltage from the drive input power.		<ul style="list-style-type: none"> • Check the voltage. • Correct the voltage to within range listed in drive input power specifications.
The power has been interrupted.		Correct the drive input power.
Drive internal circuitry has become worn.		<ul style="list-style-type: none"> • Check the maintenance time for the capacitors (U4-05). • Replace the drive if U4-05 exceeds 90%.
The drive input power transformer is not large enough and voltage drops after switching on power.		Check the capacity of the drive input power transformer.
Air inside the drive is too hot.		Check the drive internal temperature.
Problem with the CHARGE indicator.		Replace the drive.
LED Operator Display		Fault Name
	Uv3	Undervoltage 3 (Inrush Prevention Circuit Fault) The inrush prevention circuit has failed.
Cause		Possible Solution
The contactor on the inrush prevention circuit is damaged.		<ul style="list-style-type: none"> • Cycle power to the drive. Check if the fault reoccurs. • Replace the drive if the fault continues to occur. • Check monitor U4-06 for the performance life of the inrush prevention circuit. • Replace the drive if U4-06 exceeds 90%.

5.5 Alarm Detection

Alarms are drive protection functions that do not operate the fault contact. The drive will return to original status when the cause of the alarm has been removed.







During an alarm condition, the Digital Operator display flashes and an alarm output is generated at the multi-function output MA-MB-MC if H2-01 = 10 (H2-01 = E).

Investigate the cause of the alarm and refer to [Table 5.7](#) for the appropriate action.

◆ Alarm Codes, Causes, and Possible Solutions

Table 5.7 Alarm Codes, Causes, and Possible Solutions

LED Operator Display		Minor Fault Name	
<i>bb</i>	bb	Baseblock Drive output interrupted as indicated by an external baseblock signal.	
Cause		Possible Solutions	Minor Fault (H2-01 = 10)
External baseblock signal entered via multi-function input terminal (S1 to S5).		Check external sequence and baseblock signal input timing.	No output
LED Operator Display		Minor Fault Name	
<i>CALL</i>	CALL	Serial Communication Transmission Error Communication has not yet been established.	
Cause		Possible Solutions	Minor Fault (H2-01 = 10)
Communications wiring is faulty, there is a short circuit, or something is not connected properly.		<ul style="list-style-type: none"> • Check for wiring errors. • Correct the wiring. • Remove and ground shorts and reconnect loose wires. 	YES
Programming error on the master side.		Check communications at start-up and correct programming errors.	YES
Communications circuitry is damaged.		<ul style="list-style-type: none"> • Perform a self-diagnostics check. • Replace the drive if the fault continues to occurs. 	YES
Terminal resistance setting is incorrect.		The terminal slave drive must have the internal terminal resistance switch set correctly. Place DIP switch S2 to the ON position.	YES
LED Operator Display		Minor Fault Name	
<i>CE</i>	CE	MEMOBUS/Modbus Communication Error Control data was not received correctly for two seconds.	

Cause	Possible Solutions	Minor Fault (H2-01 = 10)
A data error occurred due to noise.	<ul style="list-style-type: none"> Check options available to minimize the effects of noise. Counteract noise in the control circuit wiring, main circuit lines and ground wiring. Reduce noise on the controller side. Use surge absorbers on magnetic contactors or other equipment causing the disturbance. Use cables recommended by Yaskawa or another type of shielded line. The shield should be grounded on the controller side or on the drive input power side. Separate all wiring for communications devices from drive input power lines. Install a noise filter to the input side of the drive input power. 	YES
Communication protocol is incompatible.	<ul style="list-style-type: none"> Check the H5 parameter settings as well as the protocol setting in the controller. Ensure settings are compatible. 	YES
Communication does not take place every 2 s.	<ul style="list-style-type: none"> Check the PLC. Change the software settings in the PLC. 	YES
Incompatible PLC software settings or there is a hardware problem.	<ul style="list-style-type: none"> Check the PLC. Remove the cause of the error on the controller side. 	YES
Communications cable is disconnected or damaged.	<ul style="list-style-type: none"> Check the connector for a signal through the cable. Replace the communications cable. 	YES
LED Operator Display		Minor Fault Name
	CrST	Can Not Reset According to the pulse input (RP), the speed deviation is greater than the setting in F1-10 for a time longer than the setting in F1-11.
Cause	Possible Solutions	Minor Fault Output (H2-01 = 10)
Fault reset was being executed when a run command was entered.	<ul style="list-style-type: none"> Ensure that a run command cannot be entered from the external terminals or option unit during fault reset. Turn off the run command. 	YES
LED Operator Display		Minor Fault Name
	EF	Forward/Reverse Run Command Input Error Both forward run and reverse run closed simultaneously for over 0.5 s.
Cause	Possible Solutions	Minor Fault Output (H2-01 = 10)
Sequence error	Check the forward and reverse command sequence and correct the problem. Note: When minor fault EF detected, motor ramps to stop.	YES
LED Operator Display		Minor Fault Name
	EF1	External fault (input terminal S1) External fault at multi-function input terminal S1.
	EF2	External fault (input terminal S2) External fault at multi-function input terminal S2.
	EF3	External fault (input terminal S3) External fault at multi-function input terminal S3.
	EF4	External fault (input terminal S4) External fault at multi-function input terminal S4.

5.5 Alarm Detection

EF5	EF5	External fault (input terminal S5) External fault at multi-function input terminal S5.	
Cause		Possible Solutions	Minor Fault Output (H2-01 = 10)
An external device has tripped an alarm function.		Remove the cause of the external fault and reset the multi-function input value.	YES
Wiring is incorrect.		<ul style="list-style-type: none"> Ensure the signal lines have been connected properly to the terminals assigned for external fault detection (H1-□□ = 20 to 2F). Reconnect the signal line. 	YES
Multi-function contact inputs are set incorrectly.		<ul style="list-style-type: none"> Check if the unused terminals have been set for H1-□□ = 20 to 2F (External Fault). Change the terminal settings. 	YES
LED Operator Display		Minor Fault Name	
oH	oH	Heatsink Overheat	
		The temperature exceeded 90-100 °C	
Cause		Possible Solutions	Minor Fault Output (H2-01 = 10)
Surrounding temperature is too high		<ul style="list-style-type: none"> Check the surrounding temperature. Improve the air circulation within the enclosure panel. Install a fan or air conditioner to cool surrounding area. Remove anything near drive that may cause extra heat. 	YES
Internal cooling fan has stopped.		<ul style="list-style-type: none"> Replace the cooling fan. <i>Refer to Cooling Fan Replacement on page 161.</i> After replacing the drive, reset the cooling fan maintenance parameter to (o4-03 = "0"). 	YES
Airflow around the drive is restricted.		<ul style="list-style-type: none"> Provide proper installation space around the drive as indicated in the manual. <i>Refer to Correct Installation Orientation on page 34.</i> Allow for the specified space and ensure that there is sufficient circulation around the control panel. 	YES
		<ul style="list-style-type: none"> Check for dust or foreign materials clogging cooling fan. Clear debris caught in the fan that restricts air circulation. 	YES
LED Operator Display		Minor Fault Name	
oL3	oL3	Overtorque 1	
		Drive output current was greater than L6-02 for longer than the time set in L6-03.	
Cause		Possible Solutions	Minor Fault Output (H2-01 = 10)
Inappropriate parameter settings.		Check parameters L6-02 and L6-03.	YES
There is a fault on the machine side (e.g., the machine is locked up).		<ul style="list-style-type: none"> Check the status of the machine. Remove the cause of the fault. 	YES
LED Operator Display		Minor Fault Name	
ov	ov	DC Bus Overvoltage	
		The DC bus voltage exceeded the trip point. For 200 V class: approximately 410 V For 400 V class: approximately 820 V (740 V when E1-01 < 400)	

5.5 Alarm Detection

There is a problem with the drive input power voltage.	<ul style="list-style-type: none">• Check the voltage.• Lower the voltage of the drive input power so that it is within the limits listed in the specifications.	YES
Drive internal circuitry is worn.	<ul style="list-style-type: none">• Check the maintenance time for the capacitors (U4-05).• Replace the drive if U4-05 exceeds 90%.	YES
The drive input power transformer is not large enough and voltage drops when the power is switched on.	<ul style="list-style-type: none">• Check for a tripped alarm when the magnetic contactor, line breaker and leakage breaker are turned on.• Check the capacity of the drive input power transformer.	YES
Air inside the drive is too hot.	<ul style="list-style-type: none">• Check the temperature inside the drive.	YES
The CHARGE indicator light is broken or disconnected.	<ul style="list-style-type: none">• Replace the drive.	YES

5.6 Operator Programming Errors

An Operator Programming Error (oPE) occurs when an inappropriate parameter is set or an individual parameter setting is inappropriate.

The drive will not operate until the parameter is set correctly; however, no alarm or fault outputs will occur. If an oPE occurs, investigate the cause and [Refer to oPE Codes, Causes, and Possible Solutions on page 139](#) for the appropriate action. When an oPE error is displayed, press the ENTER button to display U1-34 (oPE fault constant). This monitor displays the parameter causing the oPE error.

◆ oPE Codes, Causes, and Possible Solutions

Table 5.8 oPE Codes, Causes, and Possible Solutions

LED Operator Display		Error Name
oPE01	oPE01	Drive Capacity Setting Fault
		Drive capacity and then value set to o2-04 do not match.
Cause		Possible Solutions
The drive capacity setting (o2-04) and the actual capacity of the drive are not the same.		Correct the value set to o2-04.
LED Operator Display		Error Name
oPE02	oPE02	Parameter Range Setting Error
Cause		Possible Solutions
Parameters were set outside the possible setting range.		Set parameters to the proper values.
Note: Other errors are given precedence over oPE02 when multiple errors occur at the same time.		
LED Operator Display		Error Name
oPE03	oPE03	Multi-Function Input Selection Error
		A contradictory setting is assigned to multi-function contact inputs H1-01 through to H1-05.
Cause		Possible Solutions
<ul style="list-style-type: none"> The same function is assigned to two multi-function inputs. Excludes “Not used” and “External Fault.” 		<ul style="list-style-type: none"> Ensure all multi-function inputs are assigned to different functions. Re-enter the multi-function settings to ensure this does not occur.
The Up command was set but the Down command was not, or vice versa (settings 10 vs. 11).		Correctly set functions that need to be enabled in combination with other functions.
The following two functions are set at the same time: <ul style="list-style-type: none"> Up/Down Command (10 vs. 11) Hold Accel/Decel Stop (A) 		<ul style="list-style-type: none"> Check if contradictory settings have been assigned to the multi-function input terminals at the same time. Correct setting errors.
One of the following settings at the multi-function input terminals: <ul style="list-style-type: none"> External Search Command 1 and External Search Command 2 (61 vs. 62) Fast-Stop N.O. and Fast-Stop N.C. (15 vs. 17) 		Check for contradictory settings assigned to the multi-function input terminals at the same time. Correct setting errors.
LED Operator Display		Error Name

5.6 Operator Programming Errors

<i>oPE05</i>	oPE05	Run Command Selection Error The Run command selection parameter b1-02 is set to 3 but no option unit is installed.
Cause		Possible Solutions
Frequency reference is assigned to an option unit (b1-01 = 2) that is not connected to the drive.		Reconnect the option unit to the drive.
Frequency reference is assigned to a potentiometer (b1-01 = 3) that is not connected to the drive.		
The Run command is assigned to an option unit (b1-02 = 2) that is not connected to the drive.		
LED Operator Display		Error Name
<i>oPE 10</i>	oPE10	V/f Data Setting Error The following setting errors have occurred where: E1-04 is greater than or equal to E1-06 is greater than or equal to E1-07 is greater than or equal to E1-09.
Cause		Possible Solutions
—		Correct the settings for E1-04, -06, -07 and -09.
LED Operator Display		Error Name
<i>oPE 11</i>	oPE11	Carrier Frequency Setting Error Correct the setting for the carrier frequency.
Cause		Possible Solutions
The following simultaneous contradictory settings: C6-05 is greater than 6 and C6-04 is greater than C6-03 (carrier frequency lower limit is greater than the upper limit). If C6-05 is less than or equal to 6, the drive operates at C6-03. Upper and lower limits between C6-02 and C6-05 contradict each other.		Correct the parameter settings.

5.7 Diagnosing and Resetting Faults

When a fault occurs and the drive stops, follow the instructions below to remove whatever conditions triggered the fault, then restart the drive.

◆ Fault Occurs Simultaneously with Power Loss

WARNING! *Electrical Shock Hazard. Ensure there are no short circuits between the main circuit terminals (R/L1, S/L2, and T/L3) or between the ground and main circuit terminals before restarting the drive. Failure to comply may result in serious injury or death and will cause damage to equipment.*

1. Turn on the drive input power.
2. Use monitor parameters U2-02 (Fault Trace) to display data on the operating status of the drive just before the fault occurred.
3. Remove the cause of the fault and reset.







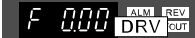

Note: [Refer to Viewing Fault Trace Data After Fault on page 141](#) for information on how to view fault trace data.

Note: When the fault continues to be displayed after cycling power, remove the cause of the fault and reset.

◆ If the Drive Still has Power After a Fault Occurs

1. Look at the LED operator for information on the fault that occurred.
2. [Refer to Fault Displays, Causes, and Possible Solutions on page 126](#)
3. Reset the fault. [Refer to Fault Reset Methods on page 142.](#)

◆ Viewing Fault Trace Data After Fault

	Step		Display/Result
1.	Turn on the drive input power. The first screen displays.	→	
2.	Press  until the monitor screen is displayed.	→	
3.	Press  to display the parameter setting screen.	→	
4.	Press  and > until U2-02 (Fault Trace) is displayed.	→	
5.	Press  to view previous fault (here, oC).	→	

5.7 Diagnosing and Resetting Faults

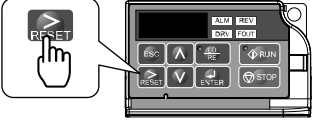
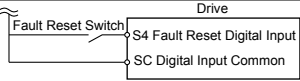
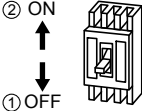

◆ Fault Reset Methods

After the Fault Occurs	Procedure	
Fix the cause of the fault, restart the drive, and reset the fault	Press  on the digital operator.	
Resetting via Fault Reset Digital Input S4	Close then open the fault signal digital input via terminal S4. S4 is set fault reset as default (H1-04 = 12)	
If the above methods do not reset the fault, turn off the drive main power supply. Reapply power after LED operator display is out.		

5.8 Troubleshooting without Fault Display



This section describes troubleshooting problems that do not trip an alarm or fault.

◆ Cannot Change Parameter Settings



Cause	Possible Solutions
The drive is running the motor (i.e., the Run command is present).	<ul style="list-style-type: none"> Stop the drive and switch over to the Programming Mode. Most parameters cannot be edited during run.
The Access Level is set to restrict access to parameter settings.	<ul style="list-style-type: none"> Set the Access Level to allow parameters to be edited (A1-02 = 2).
The operator is not in the Parameter Setup Mode (the LED screen will display “PAR”).	<ul style="list-style-type: none"> See what mode the LED parameter is current set for. Parameters cannot be edited when in the Setup Mode (“STUP”). Switch modes so that “PAR” appears on the screen.
The wrong password was entered.	<ul style="list-style-type: none"> If the password entered to A1-04 does not match the password saved to A1-05, then drive settings cannot be changed. Reset the password. <p>If you cannot remember the password:</p> <ul style="list-style-type: none"> Display parameter A1-04. Press the  button while pressing  at the same time. Parameter A1-05 will appear. Set a new password to parameter A1-05.
Undervoltage was detected.	<ul style="list-style-type: none"> Check the drive input power voltage by looking at the DC bus voltage (U1-07). Check all main circuit wiring.

◆ Motor Does Not Rotate Properly after Pressing RUN Button or after Entering External Run Command

■ Motor Does Not Rotate

Cause	Possible Solutions
The drive is not in the Drive Mode.	<ul style="list-style-type: none"> Check if the DRV light on the LED operator is lit. Enter the Drive Mode to begin operating the motor. <i>Refer to The Drive and Programming Modes on page 78.</i>
The  button was pushed.	<p>Stop the drive and check if the correct frequency reference source is selected. If the operator keypad shall be the source, the LO/RE button LED must be on, if the source is REMOTE, it must be off.</p> <p>Take the following step to solve the problem:</p> <ul style="list-style-type: none"> Push the  button.
A Fast-Stop was executed and has not yet been reset.	Reset the Fast-Stop command.
Settings are incorrect for the source that provides the run command.	<p>Check parameter b1-02 (Run Command Selection). Set b1-02 so that it corresponds with the correct run command source.</p> <p>0: LED/LCD operator 1: Control circuit terminal (default setting) 2: MEMOBUS/Modbus communications</p>

5.8 Troubleshooting without Fault Display

Cause	Possible Solutions
There is faulty wiring in the control circuit terminals.	<ul style="list-style-type: none"> Check the wiring for the control terminal. Correct wiring mistakes. Check the input terminal status monitor (U1-10).
The drive has been set to accept the frequency reference from the incorrect source.	<p>Check parameter b1-01 (Frequency Reference Selection 1). Set b1-01 to the correct source of the frequency reference.</p> <p>0: LED operator 1: Control circuit terminal (default setting) 2: MEMOBUS/Modbus communications 3: Potentiometer (option)</p>
The terminal set to accept the main speed reference is set to the incorrect voltage and/or current.	Check DIP switch S1. Next assign the correct input level to terminal A1 (H3-01). <i>Refer to DIP Switch S1 Analog Input Signal Selection on page 63.</i>
Selection for the sink/source mode is incorrect.	Check DIP switch S3. <i>Refer to Sinking/Sourcing Mode Switch on page 60.</i>
Frequency reference is too low.	<ul style="list-style-type: none"> Check the frequency reference monitor (U1-01). Increase the frequency by changing the maximum output frequency (E1-09).
The  button was pressed when the drive was started from a REMOTE source. .	<ul style="list-style-type: none"> When the  button is pressed, the drive will decelerate to stop. Switch off the run command and then re-enter a run command. The  button is disabled when o2-02 is set to 0.
Motor is not producing enough torque.	<ul style="list-style-type: none"> Ensure the selected V/f pattern corresponds with the characteristics of the motor being used. Increase both the minimum and mid output frequency voltages (E1-08, E1-10).
	Increase the frequency reference so that it is higher than the minimum frequency reference (E1-09).
	Increase the torque compensation gain (C4-01).
The drive is set for both 2-Wire and 3-Wire sequence at the same time.	<ul style="list-style-type: none"> The drive is set for a 3-Wire sequence when one of parameters H1-03 through H1-05 is set to 0. If the drive is supposed to be set up for a 2-Wire sequence, then ensure parameters H1-03 through H1-05 are not set to 0. If the drive is supposed to be set up for a 3-Wire sequence, then H1-□□ must be set to 0.

■ Motor Rotates in the Opposite Direction from the Run Command

Cause	Possible Solutions
Phase wiring between the drive and motor is incorrect.	<ul style="list-style-type: none"> Check the motor wiring. Switch two motor cables (U, V, and W) to reverse motor direction. Connect drive output terminals U/T1, V/T2 and W/T3 in the right order to the corresponding motor terminals U, V, and W.

5.8 Troubleshooting without Fault Display

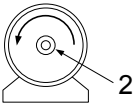
Cause	Possible Solutions
The forward direction for the motor is setup incorrectly.	<p>Typically, forward is designated as being counterclockwise when looking from the motor shaft (refer to the figure below).</p>  <p>1. Forward Rotating Motor (looking down the motor shaft) 2. Motor Shaft</p>

Note: Check the motor specifications for the forward and reverse directions. The motor specifications will vary depending on the manufacturer of the motor.

■ Motor Rotates in One Direction Only

Cause	Possible Solutions
The drive prohibits reverse rotation.	<ul style="list-style-type: none"> • Check parameter b1-04. • Set the drive to allow the motor to rotate in reverse (b1-04 = "0").
A Reverse run signal has not been entered, although 3-Wire sequence is selected.	<ul style="list-style-type: none"> • Make sure that one of the input terminals S3 to S5 used for the 3-Wire sequence has been set for reverse.

■ Motor is Too Hot

Cause	Possible Solutions
The load is too heavy.	<p>If the load is too heavy for the motor, the motor will overheat as it exceeds its rated torque value for an extended period of time. Keep in mind that the motor also has a short-term overload rating in addition to the possible solutions provided below:</p> <ul style="list-style-type: none"> • Reduce the load. • Increase the acceleration and deceleration times. • Check the values set for the motor protection (L1-01, L1-02) as well as the motor rated current (E2-01). • Increase motor capacity.
The air around the motor is too hot.	<ul style="list-style-type: none"> • Check the ambient temperature. • Cool the area until it is within the specified temperature range.
Insufficient voltage tolerance between motor phases.	<p>When the motor is connected to terminals U/T1, V/T2, and W/T3, voltage surges occur between the motor coils and drive switching. Normally, surges can reach up to three times the drive input power supply voltage (600 V for 200 V class, and 1200 V for 400 V class).</p> <ul style="list-style-type: none"> • Use a motor with voltage tolerance higher than the max voltage surge. • Use a motor designed to work specifically with a drive when using a 400 V class unit. • Install an AC reactor on the output side of the drive.
The motor fan has stopped or is clogged.	Check the motor fan.

5.8 Troubleshooting without Fault Display

■ Motor Stalls During Acceleration or With Large Loads

Cause	Possible Solutions
Load is too heavy.	Take the following steps to resolve the problem: <ul style="list-style-type: none"> • Reduce the load. • Increase the acceleration time. • Increase motor capacity. • Although the drive has a Stall Prevention function and a Torque Compensation Limit function, accelerating too quickly or trying to drive an excessively large load can exceed the capabilities of the motor.

■ Motor Will Not Accelerate or the Acceleration Time is Too Long

Cause	Possible Solutions
Frequency reference is too low.	<ul style="list-style-type: none"> • Check the maximum output frequency (E1-04). • Increase E1-04 if it is set too low.
	Check U1-01 for proper frequency reference.
	Check if a frequency reference signal switch has been set to one of the multi-function input terminals. Check for low gain level set to terminal A1 (H3-03).
Load is too heavy.	<ul style="list-style-type: none"> • Reduce the load so that the output current remains within the motor-rated current. • In extruder and mixer applications, the load will sometimes increase as the temperature drops.
	Check if the mechanical brake is fully releasing as it should.
Acceleration time has been set too long.	Check if the acceleration time parameters have been set too long (C1-01, -03).
Motor characteristics and drive parameter settings are incompatible with one another in V/f Control.	<ul style="list-style-type: none"> • Set the correct V/f pattern so that it matches the characteristics of the motor being used.
The Stall Prevention level during acceleration and deceleration set too low.	<ul style="list-style-type: none"> • Check the Stall Prevention level during acceleration (L3-02). • If L3-02 is set too low, acceleration will take a fair amount of time. • Increase L3-02.
The Stall Prevention level during run has been set too low.	<ul style="list-style-type: none"> • Check the Stall Prevention level during run (L3-06). • If L3-06 is set too low, speed will drop as the drive outputs torque. • Increase the setting value.
Drive reached the limitations.	<ul style="list-style-type: none"> • Be aware that V/f Control is comparatively limited when it comes to producing torque at low speeds.

■ Drive Frequency Reference Differs from the Controller Frequency Reference Command

Cause	Possible Solutions
The analog input frequency gain and bias are set to incorrect values.	<ul style="list-style-type: none"> • Check the main speed frequency reference terminal input gain level assigned to terminal A1, as well as the frequency reference input bias to terminal A1 (parameters H3-03 and H3-04). • Set these parameters to the appropriate values.

■ Deceleration Takes Too Long With Dynamic Braking Enabled

Cause	Possible Solutions
L3-04 is set incorrectly.	<ul style="list-style-type: none"> • Check the Stall Prevention Level during deceleration (L3-04). • If a braking resistor option has been installed, disable Stall Prevention during deceleration (L3-04 = "0").
The deceleration time is set too long.	Set deceleration to more appropriate time (C1-02 and C1-04).
Insufficient motor torque.	<ul style="list-style-type: none"> • Assuming parameter settings are normal and that no overvoltage occurs when there is insufficient torque, it is likely that the demand on the motor has exceeded the motor capacity. • Use a larger motor.
Load exceeded the internal torque limit determined by the drive rated current.	Switch to a larger capacity drive.

■ Motor Hunting Occurs When Operating With a Light Load

Cause	Possible Solutions
Carrier frequency is too high.	Lower the carrier frequency setting C6-02.
Large V/f setting value at low speeds triggers overexcitation.	<ul style="list-style-type: none"> • Use parameters E1-04 through E1-10 to set the V/f pattern in relation to the load characteristics.
The maximum output frequency and the base frequency reference are not set properly in relationship to each other.	Set the proper values for the maximum output frequency and base frequency (E1-04, E1-06).
Hunting Prevention is disabled.	<ul style="list-style-type: none"> • Enable Hunting Prevention by setting n1-02 to a value other than 0.

■ Load Falls When Brake is Applied

Cause	Possible Solutions
The timing for the brake to close and release is not set properly.	<p>Use frequency reference detection for closing and releasing the brake.</p> <ul style="list-style-type: none"> • At start: Release the brake after creating enough torque. • At stop: Close the brake when the motor still produces torque. <p>Make the following setting changes to hold the brake:</p> <ul style="list-style-type: none"> • Multi-function contact output terminal will switch on when the output frequency is greater than the frequency detection level set in L4-01. Set L4-01 between 1.0 and 3.0 Hz. • Do not use the multi-function contact output setting "During Run" (H2-01 = 0) for the brake signal.
Insufficient DC Injection Braking.	Increase the amount of DC Injection Braking (b2-02).

■ Noise From Drive or Output Lines When the Drive is Powered On

Cause	Possible Solutions
Relay switching in the drive generates excessive noise.	<ul style="list-style-type: none"> • Lower the carrier frequency (C6-02). • Install a noise filter on the input side of drive input power. • Install a noise filter on the output side of the drive. • Place the wiring inside a metal conduit to shield it from switching noise. • Ground the drive and motor properly. • Separate the main circuit wiring and the control lines.

5.8 Troubleshooting without Fault Display

■ Ground Fault Circuit Interrupter (GFCI) Trips During Run

Cause	Possible Solutions
Excessive leakage current trips MCCB.	<ul style="list-style-type: none"> • Increase the GFCI sensitivity or use GFCI with a higher threshold. • Lower the carrier frequency (C6-02). • Reduce the length of the cable used between the drive and the motor. • Install a noise filter or reactor on the output side of the drive.

■ Connected Machinery Vibrates When Motor Rotates

Excessive Motor Oscillation and Erratic Rotation

Cause	Possible Solutions
Poor balance between motor phases.	Check drive input power voltage to ensure that it provides stable power.

Unexpected Noise from Connected Machinery

Cause	Possible Solutions
The carrier frequency is at the resonant frequency of the connected machinery.	Adjust the carrier frequency using parameters C6-02 through C6-05.
The drive output frequency is the same as the resonant frequency of the connected machinery.	<ul style="list-style-type: none"> • Adjust the parameters used for the Jump Frequency function (d3-01 through d3-04) to skip the problem-causing bandwidth. • Place the motor on a rubber pad to reduce vibration.

Note: The drive may have trouble assessing the status of the load due to white noise generated when using Swing PWM (C6-02 = 7) Default setting is 7 for Normal Duty.

■ Oscillation or Hunting

Cause	Possible Solutions
Insufficient tuning.	Reduce the gain. <ul style="list-style-type: none"> • n1-02 (Hunting Prevention Gain Setting)
The frequency reference is assigned to an external source.	<ul style="list-style-type: none"> • Ensure that noise is not affecting the signal lines. • Separate main circuit wiring and control circuit wiring. • Use twisted-pair cables or shielded wiring for the control circuit. • Increase the analog input time filter constant (H3-13).
The cable between the drive and motor is too long.	<ul style="list-style-type: none"> • Reduce the length of the cable.

■ Motor Rotates After the Drive Output is Shut Off

Cause	Possible Solutions
Low DC Injection Braking and the drive cannot decelerate properly.	<ul style="list-style-type: none"> • Adjust the DC Injection braking settings. • Increase the value of b2-02 (DC Injection Braking Current). • Increase the b2-04 (DC Injection Braking Time at Stop).

■ Torque or Speed Loss Occurs When Starting into a Rotating Load

Cause	Possible Solutions
The load is already rotating when the drive is trying to start it.	<ul style="list-style-type: none"> • Stop the motor using DC Injection braking. Restart the motor. • Increase the value of b2-03 (DC Injection Braking Time at start). • Set a multi-function input terminal for external Speed Search command (H1-□□="61" or "62" during restart).

■ Output Frequency is not as High as Frequency Reference

Cause	Possible Solutions
Frequency reference is set within the range of the Jump Frequency.	<ul style="list-style-type: none"> Adjust the parameters used for the Jump Frequency function (d3-01, d3-02). Enabling the Jump Frequency prevents the drive from outputting the frequencies specified in the Jump Frequency range.
Upper limit for the frequency reference has been exceeded.	<ul style="list-style-type: none"> Set the maximum output frequency and the upper limit for the frequency reference to more appropriate values (E1-04, d2-01). The following calculation yields the upper value for the output frequency = $E1-04 \times d2-01 / 100$
Large load triggered Stall Prevention function during acceleration.	<ul style="list-style-type: none"> Reduce the load. Adjust the Stall Prevention level during acceleration (L3-02).

■ Buzzing Sound from Motor at 2 kHz

Cause	Possible Solutions
Exceeded 110% of the rated output current of the drive while operating at low speeds.	<ul style="list-style-type: none"> If the output current rises too high at low speeds, the carrier frequency automatically reduces and causes a whining or buzzing sound. If the sound is coming from the motor, disable carrier frequency derating (L8-38 = "0"). Disabling the automatic carrier frequency derating increases the chances of an overload fault (oL2). Switch to a larger capacity motor if oL2 faults occur too frequently.

■ Motor Does Not Operate When the RUN Button on the Digital Operator is Pressed

Cause	Possible Solutions
The LOCAL/REMOTE mode is not selected properly.	Press the LOCAL/REMOTE button to switch. The LO/RE LED should be on for LOCAL mode.
The drive is not in drive mode.	A run command will not be issued. Exit to the drive mode and cycle the run command.
The frequency reference is too low.	<ul style="list-style-type: none"> If the frequency reference is set below the frequency set in E1-09 (Minimum Output Frequency), the drive will not operate. Raise the frequency reference to at least the minimum output frequency.

■ Motor Does Not Operate When an External Run Command is Input

Cause	Possible Solutions
The LOCAL/REMOTE mode is not selected properly.	Press the LOCAL/REMOTE button to switch. The LO/RE LED should be off for REMOTE mode.
The drive is not in Drive Mode.	A run command will not be issued. Exit to the Drive mode and cycle the run command.
The frequency reference is too low.	<ul style="list-style-type: none"> If the frequency reference is set below the frequency set in E1-09 (Minimum Output Frequency), the drive will not operate. Raise the frequency reference to at least the minimum output frequency.

5.8 Troubleshooting without Fault Display

■ Motor Stops During Acceleration or When a Load is Connected

Cause	Possible Solution
<ul style="list-style-type: none">• The load is too heavy.• The limit of motor response may be reached during rapid acceleration. This may be a result of improper stall prevention or automatic torque boost function adjustment. (L3-01 = 2)	Increase the acceleration time (C1-01) or reduce the motor load. Also, consider increasing the motor size and/or drive size.

■ Peripheral Devices Affected by Drive Operation

Cause	Possible Solutions
Radio frequency interference may be generated by drive output PWM waveform.	<ul style="list-style-type: none">• Change the Carrier Frequency Selection (C6-02) to lower the carrier frequency. This will help to reduce the amount of transistor switching noise.• Install an Input Noise Filter at the input power terminals.• Install an Output Noise Filter at the motor terminals.• Use conduit. Metal can shield electrical noise.• Ground the drive and motor.• Separate main circuit wiring from control wiring.

■ Ground Fault Interrupter Activates When Drive is Running

Cause	Possible Solutions
The output of the drive is a series of high frequency pulses (PWM), so there is a certain amount of leakage current. This may cause the ground fault interrupter to operate and cut off the drive input power.	<ul style="list-style-type: none">• Change to a ground fault interrupter with a higher leakage current detection level (such as, a sensitivity current of 200 mA or greater per Unit, with an operating time of 0.1 s or more), or one that incorporates high-frequency corrective actions.• Change the Carrier Frequency Selection (C6-02) to lower the carrier frequency. <p>Note: Leakage current increases in proportion to cable length.</p>



Periodic Inspection & Maintenance

This chapter describes the periodic inspection and maintenance of the drive to ensure that it receives the proper care to maintain overall performance.

6.1	SECTION SAFETY.....	152
6.2	INSPECTION.....	155
6.3	PERIODIC MAINTENANCE.....	159
6.4	DRIVE COOLING FANS.....	161

6.1 Section Safety

DANGER

Electrical Shock Hazard

Do not connect or disconnect wiring while the power is on.

Failure to comply will result in death or serious injury.

WARNING

Electrical Shock Hazard

Do not operate equipment with covers removed.

Failure to comply could result in death or serious injury.

The diagrams in this section may show drives without covers or safety shields to show details. Be sure to reinstall covers or shields before operating the drives and run the drives according to the instructions described in this manual.

Always ground the motor-side grounding terminal.

Improper equipment grounding could result in death or serious injury by contacting the motor case.

Do not remove covers or touch circuit boards while the power is on.

Failure to comply could result in death or serious injury.

Do not allow unqualified personnel to perform work on the drive.

Failure to comply could result in death or serious injury.

Installation, maintenance, inspection, and servicing must be performed only by authorized personnel familiar with installation, adjustment, and maintenance of AC drives.

Do not perform work on the drive while wearing loose clothing, jewelry or without eye protection.

Failure to comply could result in death or serious injury.

Remove all metal objects such as watches and rings, secure loose clothing, and wear eye protection before beginning work on the drive.

 **WARNING****Do not touch any terminals before the capacitors have fully discharged.**

Failure to comply could result in death or serious injury.

Before wiring terminals, disconnect all power to the equipment. The internal capacitor remains charged even after the power supply is turned off. The charge indicator LED will extinguish when the DC bus voltage is below 50 Vdc. To prevent electric shock, wait at least one minute after all indicators are off and measure the DC bus voltage level to confirm safe level.

Fire Hazard**Tighten all terminal screws to the specified tightening torque.**

Loose electrical connections could result in death or serious injury by fire due to overheating of electrical connections.

Do not use an improper voltage source.

Failure to comply could result in death or serious injury by fire.

Verify that the rated voltage of the drive matches the voltage of the incoming power supply before applying power.

Do not use improper combustible materials.

Failure to comply could result in death or serious injury by fire.

Attach the drive to metal or other noncombustible material.

NOTICE

Observe proper electrostatic discharge procedures (ESD) when handling the drive and circuit boards.

Failure to comply may result in ESD damage to the drive circuitry.

Never connect or disconnect the motor from the drive while the drive is outputting voltage.

Improper equipment sequencing could result in damage to the drive.

Do not use unshielded cable for control wiring.

Failure to comply may cause electrical interference resulting in poor system performance. Use shielded, twisted-pair wires and ground the shield to the ground terminal of the drive.

Do not allow unqualified personnel to use the product.

Failure to comply could result in damage to the drive or braking circuit.

Carefully review instruction manual TOBPC72060000 when connecting a braking option to the drive.

Do not modify the drive circuitry.

Failure to comply could result in damage to the drive and will void warranty.

Yaskawa is not responsible for any modification of the product made by the user. This product must not be modified.

Check all the wiring to ensure that all connections are correct after installing the drive and connecting any other devices.

Failure to comply could result in damage to the drive.

6.2 Inspection

Power electronics have limited life and may exhibit changed characteristics or performance deterioration after years of use under normal conditions. To help avoid such problems, it is important to perform preventive maintenance and periodic inspection on the drive.

Drives contain a variety of power electronics such as power transistors, semiconductors, capacitors, resistors, fans, and relays. The electronics in the drive serve a critical role in maintaining proper motor control.

Follow the inspection lists provided in this chapter as a part of a regular maintenance program.

Note: The drive will require more frequent inspection if it is placed in harsh environments, such as:

- High ambient temperatures
- Frequent starting and stopping
- Fluctuations in the AC supply or load
- Excessive vibrations or shock loading
- Dust, metal dust, salt, sulfuric acid, chlorine atmospheres
- Poor storage conditions.

Perform the first equipment inspection 3 months after installation.

◆ Recommended Daily Inspection

Table 6.1 outlines the recommended daily inspection for Yaskawa drives. Check the following items on a daily basis to avoid premature deterioration in performance or product failure. Copy this checklist and mark the “Checked” column after each inspection.

WARNING! Electrical Shock Hazard. Do not connect or disconnect wiring while the power is on. Failure to comply can result in serious personal injury. Before servicing the drive, disconnect all power to the equipment. The internal capacitor remains charged even after the power supply is turned off. The charge indicator LED will extinguish when the DC bus voltage is below 50 Vdc. To prevent electric shock, wait at least one minute after all indicators are OFF and measure the DC bus voltage level to confirm safe level.

Table 6.1 General Recommended Daily Inspection Checklist

Inspection Category	Inspection Points	Corrective Action	Checked
Motor	<ul style="list-style-type: none"> • Inspect for abnormal oscillation or noise coming from the motor. 	<ul style="list-style-type: none"> • Check the load coupling. • Measure motor vibration. • Tighten all loose components. 	
Cooling	<ul style="list-style-type: none"> • Inspect for abnormal heat generated from the drive or motor and visible discoloration. 	<ul style="list-style-type: none"> • Check for excessive load. • Loose connections • Check for dirty heatsink or motor. • Ambient temperature 	
Cooling Fan	<ul style="list-style-type: none"> • Inspect drive cooling fan operation. 	<ul style="list-style-type: none"> • Check for clogged or dirty fan. • Check fan operation drive parameter. 	
Environment	<ul style="list-style-type: none"> • Verify the drive environment complies with the specifications listed in the Installation section of this manual. 	<ul style="list-style-type: none"> • Eliminate the source of contaminants or correct poor environment. 	

6.2 Inspection

Inspection Category	Inspection Points	Corrective Action	Checked
Load	<ul style="list-style-type: none">The drive output current should not be higher than the motor or drive rating for an extended period of time.	<ul style="list-style-type: none">Check for excessive load.Check the motor parameter settings of the drive.	
Power Supply Voltage	<ul style="list-style-type: none">Check main power supply and control voltages.	<ul style="list-style-type: none">Correct the voltage or power supply to within nameplate specifications.Verify all main circuit phases.	

◆ Recommended Periodic Inspection

Table 6.2 outlines the recommended periodic inspections for Yaskawa drive installations. Periodic inspections should generally be checked every 3-6 months; however, the drive may require more frequent inspection due to poor environments or rigorous use. Operating and environmental conditions, along with experience in each application, will determine the actual inspection frequency for each installation. Periodic inspection will help to avoid premature deterioration in performance or product failure. Copy this checklist and mark the “Checked” column after each inspection.

■ Periodic Inspection

WARNING! *Electrical Shock Hazard. Do not connect or disconnect wiring while the power is on. Failure to comply can result in serious personal injury. Before servicing the drive, disconnect all power to the equipment. The internal capacitor remains charged even after the power supply is turned off. The charge indicator LED will extinguish when the DC bus voltage is below 50 Vdc. To prevent electric shock, wait at least one minute after all indicators are OFF and measure the DC bus voltage level to confirm safe level.*

Table 6.2 Periodic Inspection Checklist

Inspection Area	Inspection Points	Corrective Action	Checked
Main Circuit Periodic Inspection			
General	<ul style="list-style-type: none"> Inspect equipment for discoloration from overheating or deterioration. Inspect for damaged or deformed parts. 	<ul style="list-style-type: none"> Replace damaged components as required. The drive has few serviceable parts and may require complete drive replacement. 	
	<ul style="list-style-type: none"> Inspect for dirt, foreign particles, or dust collection on components. 	<ul style="list-style-type: none"> Inspect enclosure door seal if present. Replace components if cleaning is not possible. Use dry air to clear away foreign matter. Use a pressure of: 39.2×10^4 to 58.8×10^4 Pa (4 - 6 kg \bulletcm2). 	
Conductors and Wiring	<ul style="list-style-type: none"> Inspect wiring and connections for discoloration, damage, or heat stress. Inspect wire insulation and shielding for wear. 	<ul style="list-style-type: none"> Repair or replace damaged wiring. 	
Terminals	<ul style="list-style-type: none"> Inspect terminals for stripped, damaged, or loose connections. 	<ul style="list-style-type: none"> Tighten loose screws and replace damaged screws or terminals. 	
Relays and Contactors	<ul style="list-style-type: none"> Inspect contactors and relays for excessive noise during operation. Inspect coils for signs of overheating such as melted or cracked insulation. 	<ul style="list-style-type: none"> Check coil voltage for over or under voltage conditions. Replace damaged removable relays contactors or circuit board. 	
Braking Resistors	<ul style="list-style-type: none"> Inspect for discoloration of heat stress on or around resistors. 	<ul style="list-style-type: none"> Minor discoloration may be acceptable. If discoloration exists check for loose connections. 	
Electrolytic (bus) Capacitors	<ul style="list-style-type: none"> Inspect for leakage, discoloration, or cracks. Inspect the relief valve for swelling, rupture, or leakage. 	<ul style="list-style-type: none"> The drive has few serviceable parts and may require complete drive replacement. 	
Diodes and IGBTs	<ul style="list-style-type: none"> Inspect for accumulation of dust or other foreign particles on components. 	<ul style="list-style-type: none"> Use dry air to clear away foreign matter. Use a pressure of: 39.2×10^4 to 58.8×10^4 Pa (4 - 6 kg \bulletcm2). 	
Control Circuit Periodic Inspection			
General	<ul style="list-style-type: none"> Inspect terminals for stripped, damaged or loose connections. Check for tightness. 	<ul style="list-style-type: none"> Tighten loose screws and replace damaged screws or terminals. If terminals are integral to a circuit board then board or drive replacement may be required. 	
Printed Circuit Boards	<ul style="list-style-type: none"> Inspect for unusual discoloration, burning or strange odor, noticeable rust or corrosion, proper seating of connectors, dust, oil, or other contamination. 	<ul style="list-style-type: none"> Re-seat loose connectors. Replace PCBs if wiping or vacuuming with anti-static vacuum cannot clean the PCB. Do not use solvents on PCBs. Use dry air to clear away foreign matter. Use a pressure of: 39.2×10^4 to 58.8×10^4 Pa (4 - 6 kg \bulletcm2). The drive has few serviceable parts and may require complete drive replacement. 	

6.2 Inspection

Inspection Area	Inspection Points	Corrective Action	Checked
LED Periodic Inspection			
LEDs	<ul style="list-style-type: none"> • Make sure the LED lights correctly. • Inspect for dust or other foreign material that may have collected on surrounding components. 	<ul style="list-style-type: none"> • Contact your Yaskawa representative if there is any trouble with the LED or keypad. • Clean the LED. 	
Cooling System Periodic Inspection			
Cooling Fan	<ul style="list-style-type: none"> • Check for abnormal oscillation or unusual noise. • Check for damaged or missing fan blades. 	<ul style="list-style-type: none"> • Replace as required. • <i>Refer to Drive Cooling Fans on page 161</i> for information on cleaning or replacing the cooling fan. 	
Heatsink	<ul style="list-style-type: none"> • Inspect for dust or other foreign material collected on the surface. 	<ul style="list-style-type: none"> • Use dry air to clear away foreign matter. • Use a pressure of 39.2×10^4 to 58.8×10^4 Pa (4 - 6 kg•cm²). 	
Air Duct	<ul style="list-style-type: none"> • Inspect air intake and exhaust openings. They must be free from obstruction and properly installed. 	<ul style="list-style-type: none"> • Visually inspect the area. • Clear obstructions and clean air duct as required. 	
Motor Periodic Inspection			
Operation Check	<ul style="list-style-type: none"> • Check for increased vibration or abnormal noise. 	<ul style="list-style-type: none"> • Stop the motor and contact qualified maintenance personnel as required. 	

Note: Periodic inspections should be performed every one or two years. The drive, however, may require more frequent inspection due to poor environments or rigorous use.

6.3 Periodic Maintenance

The drive has various "maintenance monitors." This feature provides advance maintenance warning and eliminates the need to shut down the entire system for unexpected problems. The drive allows the user to check the following maintenance periods.

- Cooling Fan
- Electrolytic Capacitors (Main Circuit)
- Inrush Prevention Circuit
- IGBT

◆ Replacement Parts

Table 6.3 contains the estimated performance life of components that require replacement during the life of the drive. Only use Yaskawa replacement parts for the appropriate drive model and revision.

Table 6.3 Estimated Performance Life

Component	Estimated Performance Life
Cooling Fan	2 ~ 3 years
Electrolytic Capacitors (Main Circuit)	10 years </>

<|> The drive has few serviceable parts and may require complete drive replacement.

NOTICE: *Estimated performance life based on specific usage conditions. These conditions are provided for the purpose of replacing parts to maintain performance. Some parts may require more frequent replacement due to poor environments or rigorous use.*

Usage conditions for estimated performance life:

- Ambient temperature: Yearly average of 30 °C
- Load factor: 80% maximum
- Operation time: 12 hours a day

■ Performance Life Monitors

The drive calculates the maintenance period for components that may require replacement during the life of the drive. A percentage of the maintenance period is displayed on the LED digital operator by viewing the appropriate monitor parameter.

When the maintenance period reaches 100%, there is increased risk that the drive may malfunction. Yaskawa recommends checking the maintenance period regularly to ensure maximum performance life.

Refer to Recommended Periodic Inspection on page 156 for more details.

Table 6.4 Performance Life Monitors Used for Component Replacement

Parameter	Component	Contents
U4-04	Cooling Fan	Displays the accumulated cooling fan operation time as a percentage of the specified maintenance period (displayed in percent %).
U4-05	Main Circuit (DC bus) Electrolytic Capacitors	Displays the accumulated time the capacitors are used as a percentage of the specified maintenance period.

6.3 Periodic Maintenance

Parameter	Component	Contents
U4-06	Inrush (pre-charge) relay	Displays the number of times the drive is powered up as a percentage of the performance life of the inrush circuit.
U4-07	IGBT	Displays the percentage of the maintenance period reached by the IGBTs.

■ Related Drive Parameters

Table 6.5 Maintenance Parameter Settings

Parameter	Parameter Name	Control Mode
	Operator Display	V/f
o4-03	Cooling Fan Maintenance Setting (Operation Time)	A
o4-05	Capacitor Maintenance Setting	A
o4-07	Inrush Prevention Relay (pre-charge) Maintenance Setting	A
o4-09	IGBT Maintenance Setting	A

NOTICE: After replacing parts, reset the appropriate maintenance parameters (o4-03, o4-05, o4-07, and o4-09) to 0. If these parameters are not reset, the function will continue to count down the performance life of the new replaced components.

6.4 Drive Cooling Fans

NOTICE: Follow cooling fan replacement instructions. The cooling fan cannot operate properly when installed incorrectly and could seriously damage the drive. To ensure maximum useful product life, replace all cooling fans when performing maintenance.

Contact your Yaskawa representative or supplier to order replacement cooling fans as required.

Some drive models have multiple cooling fans.

For drives with multiple cooling fans, replace all the fans when performing maintenance to ensure maximum useful product life.

◆ Cooling Fan Replacement

The cooling fan is installed on the top of the drive. The cooling fan can easily be replaced without tools or removal of the drive or enclosure parts.

WARNING! *Electrical Shock Hazard. Do not connect or disconnect wiring while the power is on. Failure to comply can result in serious personal injury. Before servicing the drive, disconnect all power to the equipment. The internal capacitor remains charged even after the power supply is turned off. The charge indicator LED will extinguish when the DC bus voltage is below 50 Vdc. To prevent electric shock, wait at least one minute after all indicators are OFF and measure the DC bus voltage level to confirm safe level.*

CAUTION! *Burn Hazard. Do not touch a hot drive heatsink. Failure to comply could result in minor or moderate injury. Shut off the power to the drive when replacing the cooling fan. To prevent burns, wait at least 15 minutes and ensure the heatsink has cooled down.*

■ Removing the Cooling Fan

1. Depress the right and left sides of the fan cover tabs and pull upward. Remove the fan cover from the top of the drive. The following figure illustrates a drive with a single cooling fan.

6.4 Drive Cooling Fans

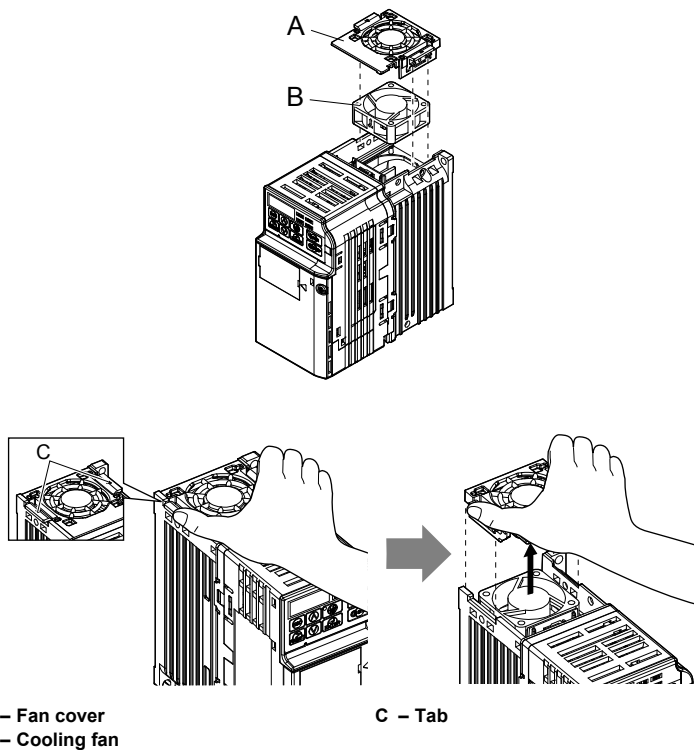
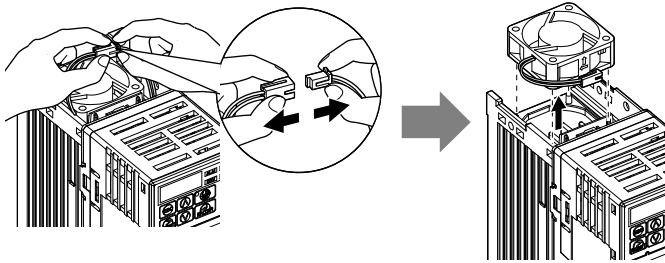

Figure 6.1 Remove the Cooling Fan Cover

2. Remove the fan cable carefully, disconnect the pluggable connector and remove the fan.



■ Installing the Cooling Fan

NOTICE: Prevent Equipment Damage. Follow cooling fan replacement instructions. Improper cooling fan replacement could result in damage to equipment. When installing the replacement cooling fan into the drive, make sure the fan is facing upwards. To ensure maximum useful product life, replace all cooling fans when performing maintenance.

1. Install the replacement cooling fan into the drive, ensuring the alignment pins line up, as shown in the figure below:

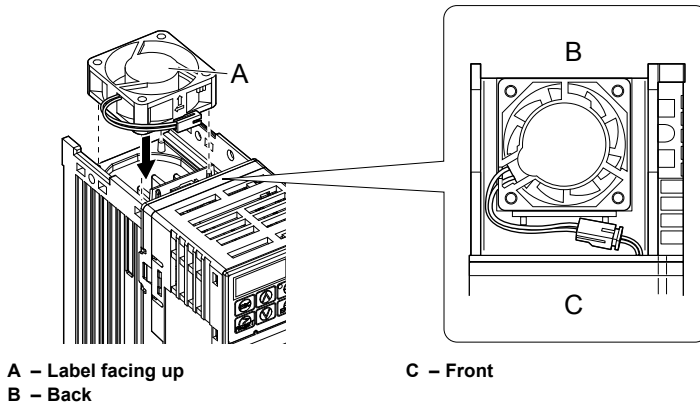
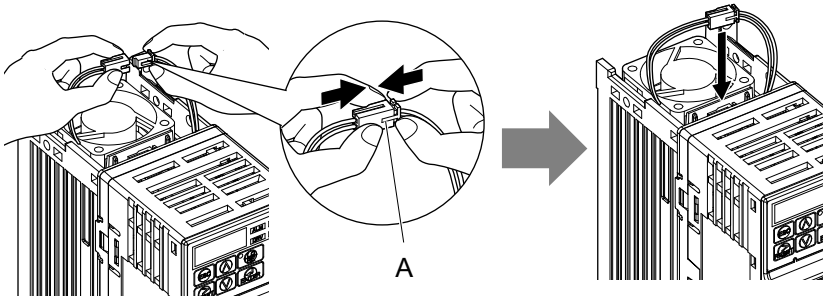

Figure 6.2 Cooling Fan Orientation

2. Ensure the connectors are properly connected and place the cable back into the recess of the drive.

6.4 Drive Cooling Fans



A – Push the connectors together so no space remains between them.

Figure 6.3 Connectors

Note: Ensure that the left and right tabs are locked back into place.

- 3.** Align the left and right cover tabs to install the fan cover back on the top of the drive.

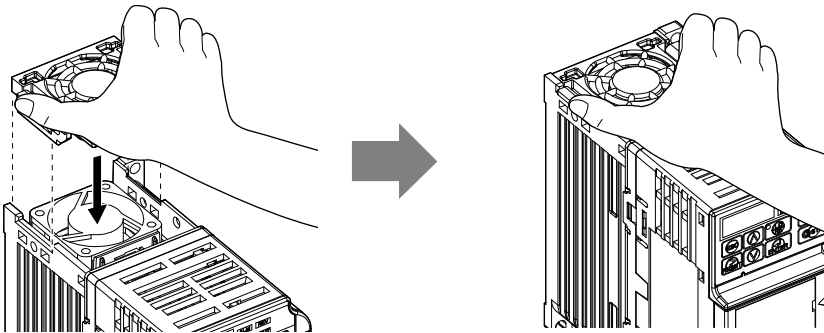

Figure 6.4 Installation



Peripheral Devices & Options

This chapter explains the installation of available peripheral devices and options for the drive.

7.1	SECTION SAFETY.....	166
7.2	PERIPHERAL DEVICES.....	168
7.3	CONNECTING PERIPHERAL DEVICES.....	170
7.4	INSTALLING PERIPHERAL DEVICES.....	171
7.5	COMMUNICATION OPTIONS.....	185

7.1 Section Safety

DANGER

Electrical Shock Hazard

Do not connect or disconnect wiring while the power is on.

Failure to comply will result in death or serious injury.

Disconnect all power to the drive, wait at least one minute after all indicators are off, measure the DC bus voltage to confirm safe level, and check for unsafe voltages before servicing to prevent electric shock. The internal capacitor remains charged even after the power supply is turned off. The charge indicator LED will extinguish when the DC bus voltage is below 50 Vdc.

WARNING

Electrical Shock Hazard

Do not operate equipment with covers removed.

Failure to comply could result in death or serious injury.

The diagrams in this section may show drives without covers or safety shields to show details. Be sure to reinstall covers or shields before operating the drives and run the drives according to the instructions described in this manual.

Do not remove covers or touch circuit boards while the power is on.

Failure to comply could result in death or serious injury.

WARNING

Do not touch any terminals before the capacitors have fully discharged.

Failure to comply could result in death or serious injury.

Before wiring terminals, disconnect all power to the equipment. The internal capacitor remains charged even after the power supply is turned off. The charge indicator LED will extinguish when the DC bus voltage is below 50 Vdc. To prevent electric shock, wait at least one minute after all indicators are off and measure the DC bus voltage level to confirm safe level.

 **WARNING****Do not allow unqualified personnel to perform work on the drive.**

Failure to comply could result in death or serious injury.

Installation, maintenance, inspection and servicing must be performed only by authorized personnel familiar with installation, adjustment and maintenance of AC drives.

Do not perform work on the drive while wearing loose clothing, jewelry or without eye protection.

Failure to comply could result in death or serious injury.

Remove all metal objects such as watches and rings, secure loose clothing and wear eye protection before beginning work on the drive.

Always ground the motor-side grounding terminal.

Improper equipment grounding could result in death or serious injury by contacting the motor case.

 **WARNING****Do not change wiring or remove option unit while power is running through the drive.**

Failure to comply could result in death or serious injury.

Disconnect all power to the drive and check for unsafe voltages before servicing.

Tighten all terminal screws to the specified tightening torque.

Loose electrical connections could result in death or serious injury by fire due to overheating of electrical connections.

NOTICE**Observe proper electrostatic discharge procedures (ESD) when handling the drive and circuit boards.**

Failure to comply may result in ESD damage to the drive circuitry.

Never connect or disconnect the motor from the drive while the drive is outputting voltage.

Improper equipment sequencing could result in damage to the drive.

7.2 Peripheral Devices

The following table of peripheral devices lists the names of the various devices/options available for Yaskawa drives. Contact Yaskawa or your Yaskawa agent to order these peripheral devices.















- **Peripheral Device Selection:** Refer to Yaskawa catalog for selection and part numbers.
- **Peripheral Device Installation:** Refer to option manual for option installation instructions.

Table 7.1 Available Peripheral Devices

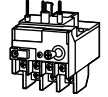
Name	
Molded Case Circuit Breaker (MCCB)	NF Series
Leakage Breaker	NV Series or EG, SG Series
Magnetic Contactor	SC Series
Surge Protector	200 V Class: DCR2-□ A 400 V Class: RFN3AL-504KD
Isolator	DGP□□□
Zero-Phase Reactor	F6045GB
Input Noise Filter	LNFD Series LNFDDB Series
Fuse	CR6L Series or A6T Series
DC Reactor	UZDA Series
AC Reactor	UZBA Series
Braking Resistor	ERF-150WJ Series
Braking Resistor Unit	LKEB Series
Output Noise Filter	LF-310 Series
Frequency Meter/Ammeter	DCF-6A
Frequency Setting Potentiometer (20 kΩ)	RH000739
Frequency Meter Scale Correction Resistor (20 kΩ)	RH000850
Speed Potentiometer	CM-3S
Output Voltmeter	SDF-12
Meter Plate	NPJT41561-1
Attachment for External Heatsink	Contact Yaskawa
DIN Rail Attachments	100-035-0□□ or EZZ08122□
NEMA Type 1 Kit	Contact Yaskawa
Software Engineering Tools Drive Wizard Plus	Contact Yaskawa

The following table lists some of the available peripheral devices found in the previous table along with a picture of the device to help identify and describe situations that may require each device.

Table 7.2 Specific Peripheral Devices and Purposes

Device	Purpose	Device	Purpose
	Molded Case Circuit Breaker (MCCB) Protects the main circuit and devices wired to the main circuit while providing overload protection.		Braking Resistor For uses requiring dynamic braking. If capacity is greater than 3%, increase capacity.
	Leakage Breaker Switches off potentially harmful leakage current.		Braking Resistor Unit For uses requiring dynamic braking. If the capacity is greater than 10% of the rated value, increase capacity.
	Magnetic Contactor (MC) Disconnects the power supply and protects the braking resistor.		Output Noise Filter Reduces noise generated from the output side of the drive.
	AC Reactor Protects the drive when power supply is too large. Required for power supplies greater than 600 kVA.		Backup Contactor A contactor for backup when the drive has faulted or for commercial power source operation.
	DC Reactor Harmonic suppression. Improves the power factor of the power supply		Thermal Relay Protects the motor from overload.
	Input Noise Filter Reduces the amount of noise flowing back into the power supply.		Zero Phase Reactor Reduces the electromagnetic induction noise generated from the drive.
	Software Engineering Tools Software for selecting drive capacity, customizing, and programming the drive.		Surge Protector Suppresses surge voltage generated from switching the MC.
	Fuse Protects the drive in case of short circuit.		

7.3 Connecting Peripheral Devices

Figure 7.1 illustrates how the drive and motor connect together with various peripheral devices.

- Refer to peripheral device option manual for detailed installation instructions.

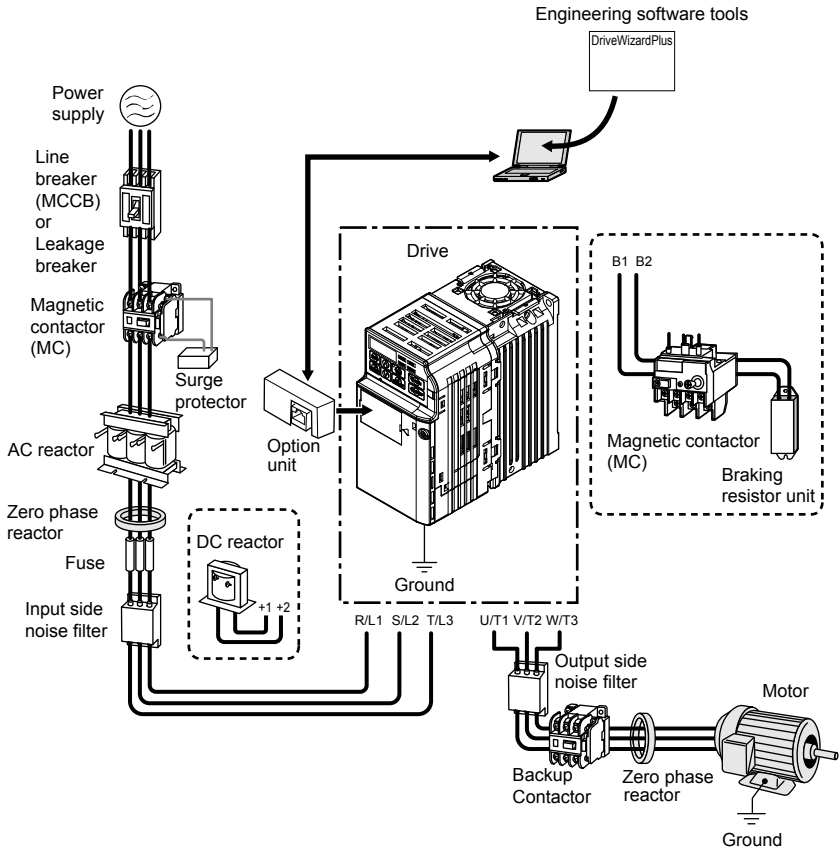

Figure 7.1 Connecting Peripheral Devices

7.4 Installing Peripheral Devices

This section describes the proper steps and precautions to take when installing or connecting various peripheral devices to the drive.

- Refer to peripheral device manual for detailed installation instructions.

NOTICE: Use a class 2 power supply (UL standard) when connecting to the control terminals. Improper application of peripheral devices could result in drive performance degradation due to improper power supply.

◆ Installing a Molded Case Circuit Breaker (MCCB)

Install a MCCB for line protection between the power supply and the main circuit power supply input terminals R/L1, S/L2 and T/L3. This protects the main circuit and devices wired to the main circuit while also providing overload protection.

Consider the following when selecting and installing an MCCB:

- The capacity of the MCCB should be 1.5 to 2 times the rated output current of the drive. Use an MCCB to keep the drive from faulting out instead of using overheat protection (150% for one minute at the rated output current).
- If several drives are connected to one MCCB or an MCCB is shared with other equipment, use a sequence that shuts the power OFF when errors are output by using magnetic contactor (MC) as shown in the following figure.

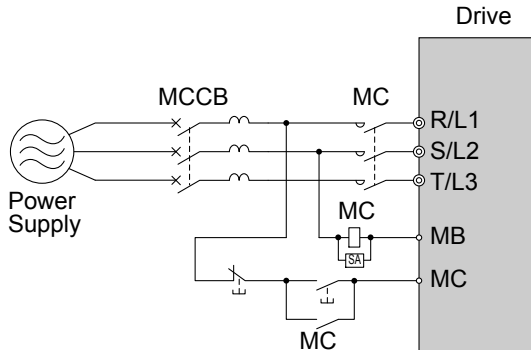

Figure 7.2 Connecting a MCCB (Three-Phase 200 V Class)

7.4 Installing Peripheral Devices

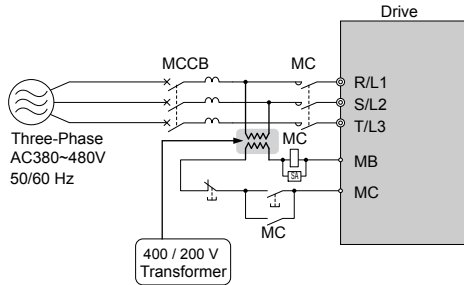

Figure 7.3 Connecting a MCCB (Three-Phase 400 V Class)

WARNING! *Electrical Shock Hazard. Disconnect the MCCB and MC before wiring terminals. Failure to comply may result in serious injury or death.*

◆ Installing a Leakage Breaker

Drive outputs generate high-frequency leakage current as a result of high-speed switching. Install a Ground Fault Circuit Interrupter (GFCI) on the input side of the drive to switch off potentially harmful leakage current.

Factors in determining leakage current:

- Size of the AC drive
- AC drive carrier frequency
- Motor cable type and length
- EMI/RFI filter

In order to safely protect the drive system, select a breaker that senses all types of current (AC and DC) and high frequency currents.

Note: Choose a GFCI designed specifically for an AC drive. The operation time should be at least 0.1 second with sensitivity amperage of at least 200 mA per drive. The output waveform of the drive may cause the leakage current to increase. This may, in turn, cause the leakage breaker to malfunction. Take the following steps to correct the problem:

- Increase the sensitivity amperage.
- Lower the carrier frequency.

◆ Installing a Magnetic Contactor

■ Disconnecting the Power Supply

The drive can be shut off in the case of a fault in external equipment such as braking resistors through use of a Magnetic Contactor (MC).

NOTICE: Install the MC on the input side of the drive when the drive should not automatically restart after power loss. To get the full performance life out of the electrolytic capacitors and circuit relays, refrain from switching the MC more than once every 30 minutes. Frequent use can damage the drive. Use the drive to stop and start the motor.

■ Protecting the Braking Resistor or Braking Resistor Unit

Use an MC on the input side of the drive to protect a braking resistor or braking resistor unit from overheat or fire.

WARNING! Fire Hazard. When using a braking unit, use a thermal relay on the braking resistors and configure a fault contact output for the braking resistor unit to disconnect drive main power via an input contactor. Inadequate braking circuit protection could result in death or serious injury by fire from overheating resistors.

◆ Connecting an AC or DC Reactor

AC and DC reactors suppress surges in current and improve the power factor on the input side of the drive.

Use a DC reactor or AC reactor or both:

- To suppress harmonic current or improve the power factor of the power supply.
- When using an advancing capacitor switch.
- With a large capacity power supply transformer (over 600 kVA).

Note: Use an AC or DC reactor when also connecting a thyristor converter (such as a DC drive) to the same power supply system, regardless of the conditions of the power supply.

■ Connecting an AC Reactor

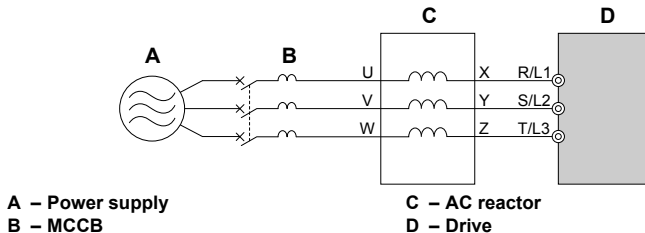

Figure 7.4 Connecting an AC Reactor

■ Connecting a DC Reactor

Ensure the jumper between terminals +1 and +2 (terminals are jumpered for shipment) is removed when connecting a DC reactor. The jumper must be installed if no DC reactor is used. [Refer to Connecting a DC Reactor on page 174](#) for an example of DC reactor wiring.

7.4 Installing Peripheral Devices

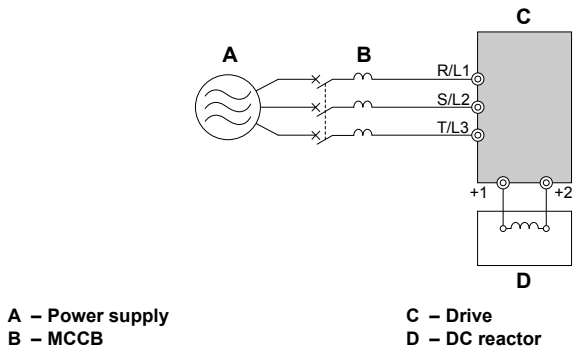

Figure 7.5 Connecting a DC Reactor

◆ Connecting a Surge Absorber

A surge absorber suppresses surge voltage generated from switching an inductive load near the drive. Inductive loads include magnetic contactors, relays, valves, solenoids and brakes. Always use a surge absorber or diode when operating with an inductive load.

Note: Never connect a surge absorber to the drive output.

◆ Connecting a Noise Filter

■ Input-Side Noise Filter

Drive outputs generate noise as a result of high-speed switching. This noise flows from inside the drive back toward the power supply, possibly affecting other equipment. Installing a noise filter to the input side of the drive can reduce the amount of noise flowing back into the power supply. This also prevents noise from entering the drive from the power supply.

- Use a noise filter specifically designed for AC drives.
- Install the noise filter as close as possible to the drive.

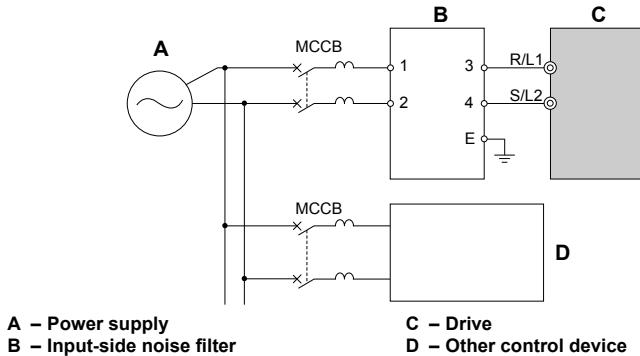

Figure 7.6 Input-Side Noise Filter (Single-Phase 200 V)

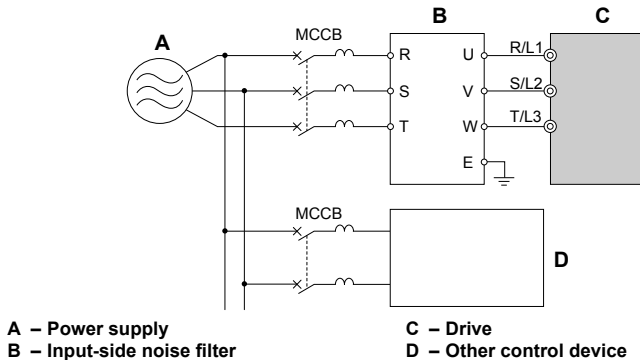

Figure 7.7 Input-Side Noise Filter (Three-Phase 200/400 V)

■ Output-Side Noise Filter

A noise filter on the output side of the drive reduces inductive noise and radiated noise. [Figure 7.8](#) illustrates an example of output-side noise filter wiring.

NOTICE: Do not connect phase-advancing capacitors or LC/RC noise filters to the output circuits. Improper application of noise filters could result in damage to the drive.

7.4 Installing Peripheral Devices

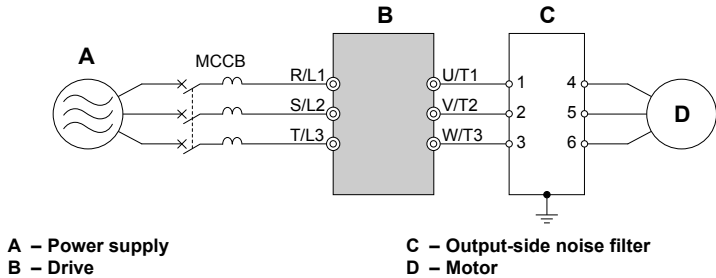

Figure 7.8 Output-Side Noise Filter

- **Radiated Noise:** Electromagnetic waves radiated from the drive and cables create noise throughout the radio bandwidth that can affect devices.
- **Induced Noise:** Noise generated by electromagnetic induction can affect the signal line and may cause the controller to malfunction.

Preventing Induced Noise

Use a noise filter on the output side or use shielded cables. Lay the cables at least 30 cm away from the signal line to prevent induced noise.

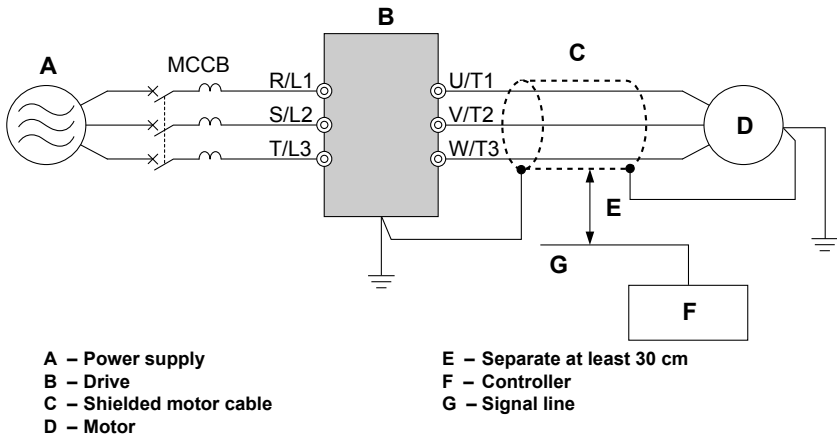

Figure 7.9 Preventing Induced Noise

Reducing Radiated/Radio Frequency Noise

The drive, input lines, and output lines generate radio frequency noise. Use noise filters on input and output sides and install the drive in a metal enclosure panel to reduce radio frequency noise.

Note: The cable running between the drive and motor should be as short as possible.

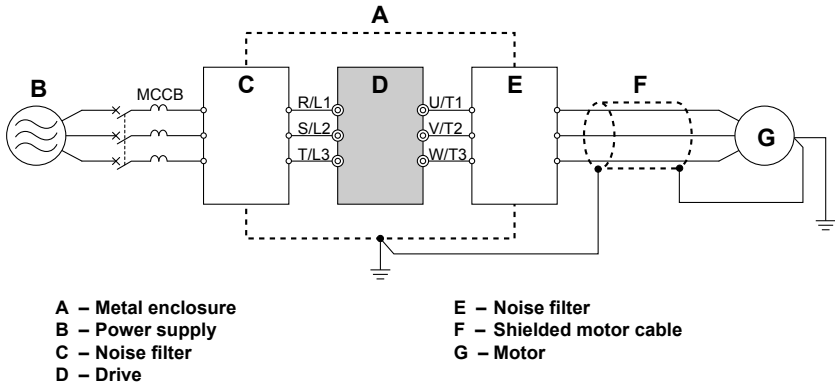

Figure 7.10 Reducing Radio Frequency Noise

◆ Zero-Phase Reactor

A zero-phase reactor can be used to reduce the noise on the input and output sides of the drive.

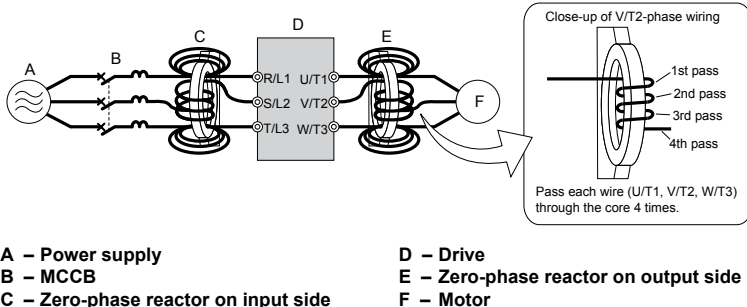

Figure 7.11 Zero-Phase Reactor

7.4 Installing Peripheral Devices

◆ Installing Fuses on the Input Side

Install recommended UL-approved fuses at the main power input of the drive. Select fuses according to [Table 7.3](#).

Table 7.3 Recommended Input Fuse Selection

Drive Model CIMR-J□	Class T Fuses		Class L Fuses	
	Model	Fuse Ampere Rating	Model	Fuse Ampere Rating
200 V Class Single-Phase Drives				
BA0001	A6T15	15	CR6L-20/UL	20
BA0002	A6T20	20	CR6L-30/UL	30
BA0003	A6T20	20	CR6L-50/UL	50
BA0006	A6T40	40	CR6L-75/UL	75
BA0010	A6T40	40	CR6L-100/UL	100
200 V Class Three-Phase Drives				
2A0001	A6T10	10	CR6L-20/UL	20
2A0002	A6T10	10	CR6L-20/UL	20
2A0004	A6T15	15	CR6L-20/UL	20
2A0006	A6T20	20	CR6L-30/UL	30
2A0008	A6T25	25	CR6L-50/UL	50
2A0010	A6T25	25	CR6L-50/UL	50
2A0012	A6T30	30	CR6L-50/UL	50
2A0018	A6T40	40	CR6L-75/UL	75
2A0020	A6T40	40	CR6L-75/UL	75
400 V Class Three-Phase Drives				
4A0001	A6T10	10	CR6L-20/UL	20
4A0002	A6T10	10	CR6L-20/UL	20
4A0004	A6T20	20	CR6L-50/UL	50
4A0005	A6T25	25	CR6L-50/UL	50
4A0007	A6T25	25	CR6L-50/UL	50
4A0009	A6T25	25	CR6L-50/UL	50
4A0011	A6T30	30	CR6L-50/UL	50

◆ Installing a Motor Thermal Overload (oL) Relay on the Drive Output

Motor thermal overload relays protect the motor by disconnecting power lines to the motor due to a motor overload condition.

Install a motor thermal overload relay between the drive and motor:

- When operating multiple motors on a single AC drive.
- When using a power line bypass to operate the motor directly from the power line.

It is not necessary to install a motor thermal overload relay when operating a single motor from a single AC drive. The AC drive has UL recognized electronic motor overload protection built into the drive software.

Note: Disable the motor protection function (L1-0 1 = “0”) when using an external motor thermal overload relay. The relay should shut off main power on the input side of the main circuit when triggered.

■ General Precautions when Using Thermal Overload Relays

The following application precautions should be considered when using motor thermal overload relays on the output of AC drives in order to prevent nuisance trips or overheating of the motor at low speeds:

- Low speed motor operation
- Use of multiple motors on a single AC drive
- Motor cable length
- Nuisance tripping resulting from high AC drive carrier frequency

Low Speed Operation and Motor Thermal oL Relays

Generally, thermal relays are applied on general-purpose motors. When general-purpose motors are driven by AC drives, the motor current is approximately 5 ~ 10% greater than if driven by the commercial power supply. In addition, the cooling capacity of a motor with a shaft-driven fan decreases when operating at low speeds. Even if the load current is within the motor rated value, motor overheating may occur. A thermal relay cannot effectively protect the motor due to the reduction of cooling at low speeds. For this reason, apply the UL recognized electronic thermal overload protection function built into the drive whenever possible.

UL recognized electronic thermal overload function of the drive: Speed-dependent heat characteristics are simulated using data from standard motors and force-ventilated motors. The motor is protected from overload using this function.

Using One Drive with Multiple Motors

Turn off the electronic thermal overload function. Please refer to the appropriate product instruction manual to determine which parameter disables this function.

The UL recognized electronic thermal overload function of the drive cannot be applied when using multiple motors on one drive.

Long Motor Cables

When long motor cables and high carrier frequency are used, nuisance tripping of the thermal relay may occur due to increased leakage current. Therefore, reduce the carrier frequency or increase the tripping level of the thermal overload relay.

Nuisance Tripping Resulting from High AC Drive Carrier Frequency

Current waveforms generated by high carrier frequency PWM drives tend to create additional temperature rise in overload relays. Therefore, it may be necessary to increase the trip level setting when encountering nuisance triggering of the relay.

7.4 Installing Peripheral Devices

WARNING! Fire Hazard. Confirm an actual motor overload condition is not present prior to increasing the thermal oL trip setting. Check local electrical codes before making adjustments to motor thermal overload settings.

◆ NEMA Type 1 Kit

WARNING! Fire Hazard. Provide sufficient cooling when installing the drive inside an enclosed panel or cabinet. Failure to comply could result in overheating and fire. When multiple drives are placed inside the same enclosure panel, install proper cooling to ensure air entering the enclosure does not exceed 40 °C.

An IP20 drive becomes a NEMA Type 1 drive with the NEMA 1 Kit. Contact Yaskawa for details. [Refer to Installation Orientation and Spacing on page 34](#) for installation instructions.

■ Installation Environment

Table 7.4 Installation Environment

Environment	Conditions
Ambient Temperature	-10 °C to +40 °C (NEMA Type 1/wall-mounted enclosure) Drive reliability improves in environments without wide temperature fluctuations. When using an enclosure panel, install a cooling fan or air conditioner in the area to ensure that the air temperature inside the enclosure does not exceed the specified levels. Do not allow ice to develop on the drive.
Refer to Installation Environment on page 33 for all other installation environment specifications.	

■ Exterior and Mounting Dimensions for NEMA Type 1 Kit

The following table matches each drive model with its appropriate drawing.

Table 7.5 Drive Models and Types

Protective Design	Drive Model CIMR-J□			Page
	Single-Phase 200 V Class	Three-Phase 200 V Class	Three-Phase 400 V Class	
NEMA Type 1	B□0001F B□0002F B□0003F	2□0001F 2□0002F 2□0004F	–	181
	B□0006F B□0010F	2□0006F 2□0008F 2□0010F 2□0012F 2□0018F 2□0020F	4□0001F 4□0002F 4□0004F 4□0005F 4□0007F 4□0009F 4□0011F	182

7.4 Installing Peripheral Devices

Table 7.6 NEMA Type 1 (without an EMC filter)

Voltage Class	Drive Model CIMR-J□	Dimensions (mm)													
		W	H	D	W1	H1	H2	H3	H4	H5	H6	D1	D2	t1	Weight (kg)
Single-Phase 200 V Class	BA0001F	68	148	76	56	128	118	4.4	20	5	1.5	6.5	67.5	3	0.8
	BA0002F	68	148	76	56	128	118	4.4	20	5	1.5	6.5	67.5	3	0.8
	BA0003F	68	148	118	56	128	118	4.4	20	5	1.5	38.5	109.5	5	1.2
Three-Phase 200 V Class	2A0001F	68	148	76	56	128	118	4.4	20	5	1.5	6.5	67.5	3	0.8
	2A0002F	68	148	76	56	128	118	4.4	20	5	1.5	6.5	67.5	3	0.8
	2A0004F	68	148	108	56	128	118	4.4	20	5	1.5	38.5	99.5	5	1.1
	2A0006F	68	148	128	56	128	118	4.4	20	5	1.5	58.5	119.5	5	1.3

7.4 Installing Peripheral Devices

Table 7.7 NEMA Type 1 (without an EMC filter)

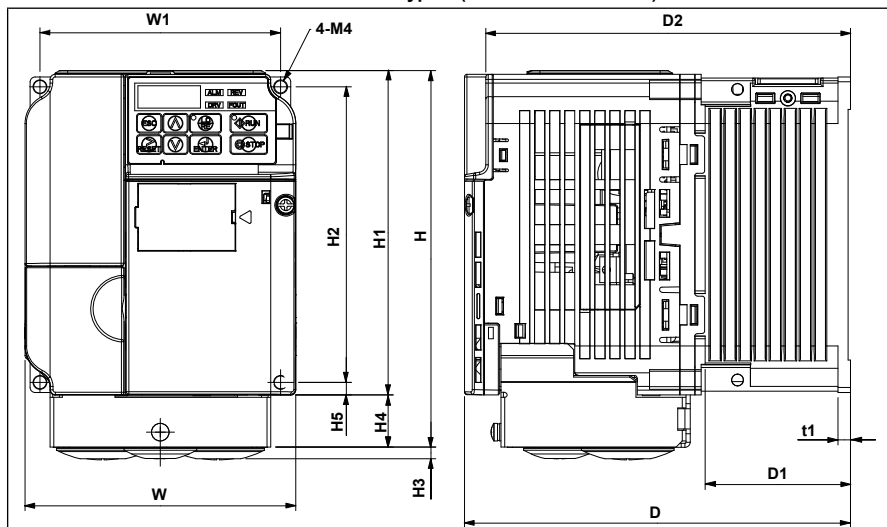

Voltage Class	Drive Model CIMR-J□	Dimensions (mm)													Weight (kg)
		W	H	D	W1	H1	H2	H3	H4	H5	H6	D1	D2	t1	
Single-Phase 200 V Class	BA0006F	108	148.9	137.5	96	128	118	4.4	20.9	5	1.5	58	129	5	1.9
	BA0010F	108	148.9	154	96	128	118	4.5	20.9	5	1.5	58	145.5	5	2.0
Three-Phase 200 V Class	2A0008F	108	148.9	129	96	128	118	4.4	20.9	5	1.5	58	120.5	5	1.9
	2A0010F	108	148.9	129	96	128	118	4.4	20.9	5	1.5	58	120.5	5	1.9
	2A0012F	108	148.9	137.5	96	128	118	4.4	20.9	5	1.5	58	129	5	1.9
	2A0018F	108	148.9	143	128	128	118	4.5	20.9	5	5	65	134.5	5	2.6
	2A0020F	108	148.9	143	128	128	118	4.5	20.9	5	5	65	134.5	5	2.6
Three-Phase 400 V Class	4A0001F	108	148.9	81	96	128	118	4.4	20.9	5	1.5	10	72.5	5	1.2
	4A0002F	108	148.9	99	96	128	118	4.4	20.9	5	1.5	28	90.5	5	1.4
	4A0004F	108	148.9	137.5	96	128	118	4.4	20.9	5	1.5	58	129	5	1.9
	4A0005F	108	148.9	154	96	128	118	4.5	20.9	5	1.5	58	145.5	5	1.9
	4A0007F	108	148.9	154	96	128	118	4.5	20.9	5	1.5	58	145.5	5	1.9
	4A0009F	108	148.9	154	96	128	118	4.5	20.9	5	1.5	58	145.5	5	1.9
	4A0011F	108	148.9	143	128	128	118	4.5	20.9	5	5	65	134.5	5	2.6

■ Removing the Protective Covers on a NEMA Type 1 Design

1. Loosen the screw on the front cover to remove the front cover.

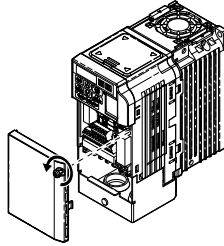

Figure 7.12 Remove the Front Cover on a NEMA Type 1 Drive

2. Loosen the screw on the terminal cover ([Figure 7.13, B](#)) to remove the terminal cover and expose the conduit bracket ([Figure 7.13, A](#)).

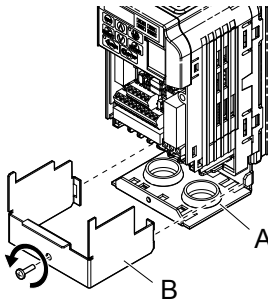

Figure 7.13 Remove the Terminal Cover on a NEMA Type 1 Drive

3. Loosen two screws attaching the conduit bracket ([Figure 7.14, A](#)) to remove.

7.4 Installing Peripheral Devices

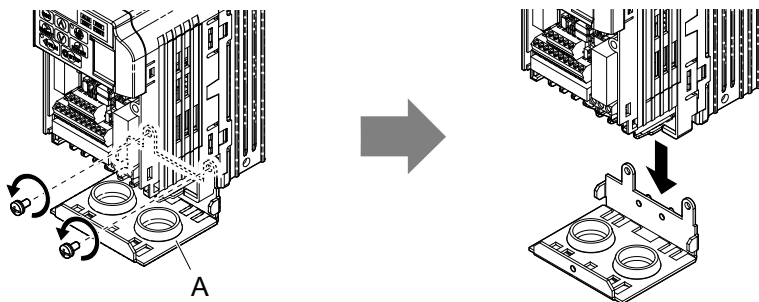
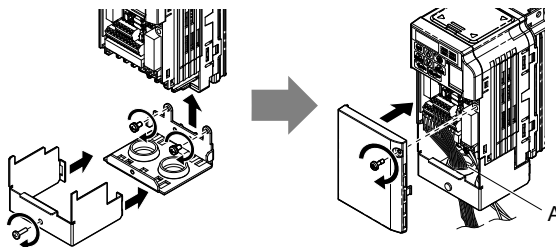

Figure 7.14 Remove the Conduit Bracket on a NEMA Type 1 Drive

■ Reattaching the Protective Covers

Pass power wiring and control signal wiring through the exit holes on the bottom of the conduit bracket of the drive. Place power wiring and control signal wiring in separate conduits. Properly connect all wiring after installing the drive and connecting other devices. Reattach all protective covers when wiring is complete.



- A – Pass power wiring and control signal wiring through different exit holes at the bottom of the drive.

Figure 7.15 Reattach the Protective Covers and Conduit Bracket on a NEMA Type 1 Drive

7.5 Communication Options

Table 7.8 gives detailed information about the available option units that allow Yaskawa drives to connect to various communications networks. A host controller can control and monitor the drive, read and change parameters by using a communication option. Refer to **Table 7.8** to determine which option unit may be necessary for a given environment. Contact Yaskawa or your Yaskawa agent to order option units.

- **Option Unit Selection:** Refer to Yaskawa catalog for more details on option unit selection and part numbers.
- **Option Unit Installation:** Refer to option unit manual for option unit installation instructions.

Table 7.8 Available Option Units

Option Unit	Model	Function
Interface for Copy Unit/PC Communication	SI-232/JC	Allows the drive to connect to an external device.
Interface for Remote Operator	SI-232/J	Allows the drive to connect to an external device.
Interface for MEMOBUS/Modbus Communication	SI-485/J	Allows the drive to connect to a network using MEMOBUS/Modbus RTU protocol.
Potentiometer Option Unit	AI-V3/J	Allows easy set-up of output frequency.
USB Copy Unit	JVOP-181	Allows the user to read, write, copy, and verify parameter settings. Connects to PC using a USB connector. For use with the RS-232C detachable interface option.
LED Operator	JVOP-182	Allows the user to read, write, copy, and verify parameter settings. Can be placed on the outside of an enclosure panel so the panel door does not have to be opened to access the drive.

This Page Intentionally Blank



Appendix: A

Specifications

A.1 HEAVY DUTY AND NORMAL DUTY RATINGS	
.....	188
A.2 SINGLE/THREE-PHASE 200 V CLASS DRIVE	
.....	189
A.3 THREE-PHASE 400 V CLASS DRIVES.....	190
A.4 DRIVE SPECIFICATIONS.....	191
A.5 DRIVE WATT LOSS DATA.....	194
A.6 DRIVE DERATING DATA.....	195

A.1 Heavy Duty and Normal Duty Ratings

The capacity of the drive is based on two types of load characteristics: Heavy Duty (HD) and Normal Duty (ND).

Refer to [Selecting the Appropriate Load Rating on page 188](#) for the differences between HD and ND. Specifications for capacity ratings are listed on the following pages.

Table A.1 Selecting the Appropriate Load Rating

Setting Parameter C6-01	Rated Output Current	Overload Tolerance	Default Carrier Frequency
0: Heavy Duty	HD Rating varies by model </>	150% rated output current for 60 s	8/10 kHz varies by model
1: Normal Duty (default)	ND Rating varies by model </>	120% rated output current for 60 s varies by model	2 kHz, Swing PWM

<1> The following pages list information on rating changes based on drive model.



- **HD and ND:** HD refers to applications requiring constant torque output, while ND refers to applications with variable torque needs. The drive allows the user to select HD or ND torque depending on the application. Fans, pumps, and blowers should use ND (C6-01 = "1"), and other applications generally use HD (C6-01 = "0").
- **Swing PWM:** Swing PWM equivalent to a 2 kHz audible noise. This function turns the motor noise into a less obtrusive white noise.

Note: Differences between HD ratings and ND ratings for the drive include rated input and output current, overload capacity, carrier frequency, and current limit. The default setting is for ND (C6-01 = 1).

A.2 Single/Three-Phase 200 V Class Drive

Table A.2 Power Ratings

Item			Specification									
Three-Phase: CIMR-J□2A			0001	0002	0004	0006	0008	0010	0012	0018	0020	
Single-Phase: CIMR-J□BA <1>			0001	0002	0003	0006	-	0010	-	-	-	
Maximum Motor Size Allowed (kW) <2>	ND Rating		0.2	0.4	0.75	1.1	1.5	2.2	3.0	3.7	5.5	
	HD Rating		0.1	0.2	0.4	0.75	1.1	1.5	2.2	3.0	3.7	
Input	Input Current (A) <3>	Three-Phase	ND Rating	1.1	1.9	3.9	7.3	8.8	10.8	13.9	18.5	24.0
			HD Rating	0.7	1.5	2.9	5.8	7.0	7.5	11.0	15.6	18.9
	Single-Phase	ND Rating	2.0	3.6	7.3	13.8	-	20.2	-	-	-	-
		HD Rating	1.4	2.8	5.5	11.0	-	14.1	-	-	-	-
Output	Rated Output Capacity (kVA) <4>	ND Rating	0.5	0.7	1.3	2.3	3.0	3.7	4.6	6.7	7.5	
		HD Rating	0.3	0.6	1.1	1.9	2.6	3.0	4.2	5.3	6.7	
	Output Current (A)	ND Rating <5>	1.2	1.9	3.5 (3.3)	6.0	8.0	9.6	12.0	17.5	19.6	
		HD Rating	0.8 <6>	1.6 <6>	3.0 <6>	5.0 <6>	6.9 <7>	8.0 <7>	11.0 <7>	14.0 <7>	17.5 <7>	
	Overload Tolerance		ND Rating: 120% of rated output current for 1 minute HD Rating: 150% of rated output current for 1 minute (Derating may be required for applications that start and stop frequently)									
	Carrier Frequency		2 kHz (user-set, 2 to 15 kHz)									
	Max Output Voltage (V)		Three-phase 200 to 240 V (proportional to input voltage)									
	Max Output Frequency (Hz)		400 Hz (user-adjustable)									
	Power Supply	Rated Voltage Rated Frequency		Three-phase power: Three-phase 200 to 240 V 50/60 Hz Single-phase power: 200 to 240 V 50/60 Hz								
		Allowable Voltage Fluctuation		-15 to 10%								
Allowable Frequency Fluctuation		±5%										
Harmonic Corrective Actions		DC Reactor		Optional								

- <1> Drives with a single-phase power supply input output three-phase power, and cannot run a single-phase motor.
- <2> The motor capacity (kW) refers to a Yaskawa 4-pole motor. The rated output current of the drive output amps should be equal to or greater than the motor rated current.
- <3> Input current rating varies depending on the power supply transformer, input reactor, wiring connections, and power supply impedance.
- <4> Rated motor capacity is calculated with a rated output voltage of 220 V.
- <5> Carrier frequency is set to 2 kHz. Current derating is required in order to raise the carrier frequency.
- <6> Carrier frequency is set to 10 kHz. Current derating is required in order to raise the carrier frequency.
- <7> Carrier frequency is set to 8 kHz. Current derating is required in order to raise the carrier frequency.

Note: Differences between Heavy Duty (HD) ratings and Normal Duty (ND) ratings for the drive include rated input and output current, overload capacity, carrier frequency and current limit. Set parameter C6-01 to “0” for HD or “1” for ND (default).

A.3 Three-Phase 400 V Class Drives

Table A.3 Power Ratings

Item		Specification							
CIMR-J□4A		0001	0002	0004	0005	0007	0009	0011	
Maximum Applicable Motor Capacity (kW) <1>	ND Rating	0.4	0.75	1.5	2.2	3.0	3.7	5.5	
	HD Rating	0.2	0.4	0.75	1.5	2.2	3.0	3.7	
Input	Input Current (A) <2>	ND Rating	1.2	2.1	4.3	5.9	8.1	9.4	14.0
		HD Rating	1.2	1.8	3.2	4.4	6.0	8.2	10.4
Output	Output Current (kVA) <3>	ND Rating <4>	0.9	1.6	3.1	4.1	5.3	6.7	8.5
		HD Rating <4>	0.9	1.4	2.6	3.7	4.2	5.5	7.0
	Output Current (A) <4>	ND Rating <4>	1.2	2.1	4.1	5.4	6.9	8.8	11.1
		HD Rating <4>	1.2	1.8	3.4	4.8	5.5	7.2	9.2
	Overload Tolerance		ND Rating: 120% of rated output current for 60 s HD Rating: 150% of rated output current for 60 s (Derating may be required for applications that start and stop frequently)						
	Carrier Frequency		2 kHz (user-adjustable from 2 to 15 kHz)						
	Maximum Output Voltage (V)		Three-phase: 380 to 480 V (proportional to input voltage)						
Maximum Output Frequency (Hz)		400 Hz (user-adjustable)							
Power Supply	Rated Voltage Rated Frequency		Three-phase: 380 to 480 V 50/60 Hz						
	Allowable Voltage Fluctuation		-15 to 10%						
	Allowable Frequency Fluctuation		±5%						
Harmonic Corrective Actions		DC Reactor		Optional					

- <1> The motor capacity (kW) refers to a Yaskawa 4-pole motor. The rated output current of the drive output amps should be equal to or greater than the motor rated current.
- <2> Input current rating varies depending on the power supply transformer, input reactor, wiring conditions, and power supply impedance.
- <3> Rated motor capacity is calculated with a rated output voltage of 440 V.
- <4> Carrier frequency is set to 2 kHz. Current derating is required in order to raise the carrier frequency.
- <5> Carrier frequency is set to 8 kHz. Current derating is required in order to raise the carrier frequency.

Note: Differences between Heavy Duty (HD) ratings and Normal Duty (ND) ratings for the drive include rated input and output current, overload capacity, carrier frequency and current limit. Set parameter C6-01 to “0” for HD or “1” for ND (default).

A.4 Drive Specifications

Note: For optimum performance life of the drive, install the drive in an environment that meets the environmental conditions.

	Item	Specification
Control Characteristics	Control Method	V/f Control
	Frequency Control Range	0.01 to 400 Hz
	Frequency Accuracy	Digital input: within $\pm 0.01\%$ of the max output frequency (-10 to +50 °C) Analog input: within $\pm 0.5\%$ of the max output frequency (25 °C ± 10 °C)
	Frequency Setting Resolution	Digital inputs: 0.01 Hz Analog inputs: 1/1000 of maximum output frequency
	Output Frequency Calculation Resolution	20 bit x Maximum output frequency (E1-04)
	Frequency Setting Signal	Main frequency reference: 0 to +10 Vdc (20 k Ω), 4 to 20 mA (250 Ω), 0 to 20 mA (250 Ω)
	Starting Torque	150%/3 Hz
	Speed Control Range	1: 20-40
	Accel/Decel Time	0.00 to 6000.0 s (allows four separate settings for accel and decel)
	Braking Torque	Instantaneous Average Decel Torque $\langle \rangle$: 0.1/0.2 kW: over 150%, 0.4/0.75 kW: over 100%, 1.5 kW: over 50%, 2.2 kW and above: over 20% Continuous Regen Torque: 20%, 125% with a Braking Resistor Unit $\langle \rangle$: (10% ED) 10 s with an internal braking resistor.
	V/f Characteristics	User-set, programmable.
Functions	<ul style="list-style-type: none"> • Momentary Power Loss Ride-Thru • Speed Search • Multi-Step Speed (9 steps max) • Accel/Decel Time Switch • S-Curve Accel/Decel • 3-Wire Sequence • Cooling Fan ON/OFF • Slip Compensation • Torque Compensation • Frequency Jump • Frequency Reference Upper/Lower Limit • DC Injection Braking (start and stop) • Excitation Braking • Fault Reset 	

A.4 Drive Specifications

Item		Specification
Protection Functions	Motor Protection Momentary	Motor overheat protection via output current sensor
	Overcurrent Protection	Drives stops when output exceeds 200% of the rated current (Heavy Duty)
	Overload Protection	A stop command will be entered after operating at 150% for 60 s (Heavy Duty) <3>
	Low Voltage Protection	Drive stops when DC bus voltage falls below the levels indicated: 190 V (3-phase 200 V), 160 V (single-phase 200 V), 380 V (3-phase 400 V), 350 V (3-phase 380 V)
	Momentary Power Loss Ride-Thru	Stops after 15 ms
	Heatsink Overheat Protection	Protected by thermistor
	Braking Resistor Overheat Protection	Overheat input signal for braking resistor (Optional ERF-type, 3% ED)
	Stall Prevention	During acceleration and during run: Separate settings for each type of stall prevention determine the current level at which stall prevention is triggered. During deceleration: Select, enable/disable.
	Cooling Fan Failure Protection	Circuit protection (“fan-lock” sensor)
	Ground Protection	Electronic circuit protection (triggered by the same levels as momentary current protection) <4>
	DC Bus Charge LED	Remains lit until DC bus voltage falls below 50 V
Environment	Storage/Installation Area	Indoors
	Ambient Temperature	-10 to +40 °C (wall-mounted enclosure) -10 to +50 °C (open chassis)
	Humidity	95% RH or less with no condensation
	Storage Temperature	-20 to +60 °C allowed for short-term transport of the product
	Altitude	1000 m or less
	Shock, Impact	10 to 20 Hz: 9.8 m/s ² 20 to 55 Hz: 5.9 m/s ²
	Surrounding Area	Install the drive in an area free from: <ul style="list-style-type: none"> • oil mist and dust • metal shavings, oil, water or other foreign materials • radioactive materials • combustible materials • harmful gases and liquids • excessive vibration • chlorides • direct sunlight
	Orientation	Install the drive vertically to maintain maximum cooling effects
Safety Regulations and Standards		Safe Disable Input according to UL508C, EN61508, SIL2; Time from input open to drive output stop is less than 1 ms.
Protective Enclosure		Open-chassis (IP20) Wall-mounted enclosure (NEMA Type 1) <5>

Item	Specification
Cooling Method	CIMR-J□BA0001 to 0006: self-cooled CIMR-J□BA0010: cooling fan CIMR-J□2A0001 to 0004: self-cooled CIMR-J□2A0006 to 0020: cooling fan CIMR-J□4A0001 to 0004: self-cooled CIMR-J□4A0005 to 0011: cooling fan

- <1> Instantaneous average deceleration torque refers to the torque required to decelerate the motor (uncoupled from the load) from the rated motor speed down to zero in the shortest time.
- <2> Ensure that Stall Prevention Selection during Deceleration is disabled (L3-04 = 0) or set to 3 when using a braking resistor or the Braking Resistor Unit. The default setting for the stall prevention function will interfere with the braking resistor.
- <3> Overload protection may be triggered when operating with 150% of the rated output current if the output frequency is less than 6 Hz.
- <4> Ground protection cannot be provided under the following circumstances when a ground fault is likely in the motor windings during run: Low ground resistance for the motor cable and terminal block; low ground resistance for the motor cable and terminal block; or the drive is powered up from a ground short.
- <5> NEMA Type 1 kit is sold separately.

A.5 Drive Watt Loss Data

Table A.4 Watt Loss 200 V Class Single-Phase Models

Model Number CIMR-J□	Heavy Duty (Carrier Frequency 8 kHz)				Normal Duty (Carrier Frequency (2 kHz)			
	Rated Amps (A)	Heatsink Loss (W)	Interior Unit Loss (W)	Total Loss (W)	Rated Amps (A)	Heatsink Loss (W)	Interior Unit Loss (W)	Total Loss (W)
BA0001	0.8	4.3	7.4	11.7	1.2	5.0	8.5	13.5
BA0002	1.6	7.9	8.9	16.7	1.9	7.6	9.7	17.3
BA0003	3.0	16.1	11.5	27.7	3.2	14.6	14.4	29.1
BA0006	5.0	33.7	16.8	50.5	6.0	30.1	19.4	49.5
BA0010	8.0	54.8	25.9	80.7	9.6	51.7	29.8	81.4

Table A.5 Watt Loss 200 V Class Three-Phase Models

Model Number CIMR-J□	Heavy Duty (Carrier Frequency 8 kHz)				Normal Duty (Carrier Frequency 2 kHz)			
	Rated Amps (A)	Heatsink Loss (W)	Interior Unit Loss (W)	Total Loss (W)	Rated Amps (A)	Heatsink Loss (W)	Interior Unit Loss (W)	Total Loss (W)
2A0001	0.8	4.3	7.3	11.6	1.2	5.0	8.0	13.0
2A0002	1.6	7.9	8.8	16.7	1.9	7.6	9.5	17.1
2A0004	3.0	16.2	11.5	27.7	3.5	15.8	13.6	29.4
2A0006	5.0	27.4	15.9	43.3	6.0	27.5	17.2	44.7
2A0008	7.0	48.7	22.2	70.9	8.0	44.6	24.0	68.6
2A0010	8.0	54.8	23.8	78.6	9.6	51.7	25.8	77.5
2A0012	11.0	70.7	29.9	100.6	12.0	61.3	30.4	91.7
2A0018	14.0	92.6	38.8	131.4	18.0	89.8	44.1	133.8
2A0020	17.5	110.5	43.3	153.8	19.6	98.7	46.3	145.0

Table A.6 Watt Loss 400 V Class Three-Phase Models

Model Number CIMR-J□	Heavy Duty (Carrier Frequency 8 kHz)				Normal Duty (Carrier Frequency 2 kHz)			
	Rated Amps (A)	Heatsink Loss (W)	Interior Unit Loss (W)	Total Loss (W)	Rated Amps (A)	Heatsink Loss (W)	Interior Unit Loss (W)	Total Loss (W)
4A0001	1.2	19.2	11.5	30.7	1.2	10.0	9.6	19.6
4A0002	1.8	28.9	14.8	43.7	2.1	18.5	13.9	32.4
4A0004	3.4	42.3	17.9	60.2	4.1	30.5	16.8	47.3
4A0005	4.8	70.7	26.2	96.9	5.4	44.5	21.8	66.3
4A0007	5.5	81.0	30.7	111.7	6.9	58.5	28.4	86.9
4A0009	7.2	84.6	32.9	117.5	8.8	63.7	31.4	95.1
4A0011	9.2	107.2	41.5	148.7	11.1	81.7	46.0	127.7

A.6 Drive Derating Data

The drive can be operated at above rated temperature, altitude and default carrier frequency by derating the drive capacity. For example, a 10 amp continuous rated drive may be operated at higher temperatures if it is only used to supply 8 amps continuous.

◆ Temperature Derating

As the ambient temperature for the drive is increased above the drive specification the drive should be derated. Additionally parameter L8-35 Installation Method Selection on page 195 should be set according to enclosure type and mounting method as illustrated in *Figure A.1* on page 195.

■ Output Current Derating Due to Ambient Temperature

If the ambient temperature is above the drive specification or if drives are side-by-side mounted in a cabinet, the parameters L8-12 and L8-35 must be set according to the installation conditions. The output current is derated as shown in *Figure A.1*.

No.	Name	Description	Range	Def.
L8-12	Ambient Temperature Setting	Adjust the drive overload (oL2) protection level when the drive is installed in an environment that exceeds its ambient temperature rating.	40 to 60	40 °C
L8-35	Installation Method Selection	0: Disabled (standard installation) 1: Side-by-Side installation 2: IP20/NEMA Type 1 3: Finless/Fin Outside installation	0 to 2	0

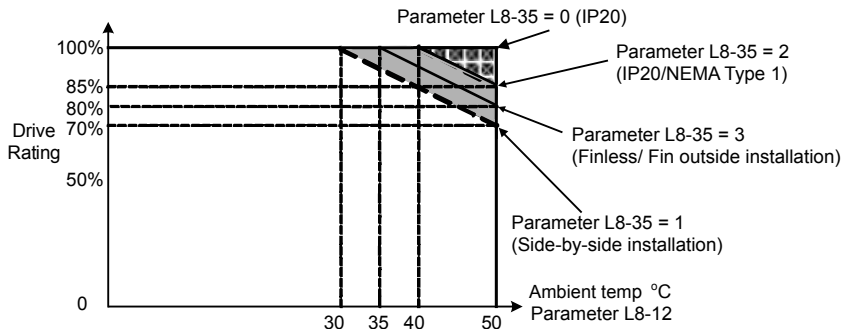

Figure A.1 Ambient Temperature and Installation Method Derating

This Page Intentionally Blank



Appendix: B

Parameter List

This appendix contains a full listing of all parameters and settings available in the drive.

B.1	PARAMETER GROUPS.....	198
B.2	PARAMETER TABLE.....	199
B.3	DEFAULTS DETERMINED BY DRIVE CAPACITY (O2-04) AND ND/HD (C6-01).....	219
B.4	DEFAULTS DETERMINED BY CARRIER FREQUENCY SELECTION (C6-02).....	222
B.5	DEFAULTS DETERMINED BY CARRIER FREQUENCY REDUCTION (L8-38).....	223

B.1 Parameter Groups

Parameter Group	Name	Page	Parameter Group	Name	Page
A1	Initialization	199	H5	Serial Communications Setup	209
b1	Sequence	199	L1	Motor Overload	210
C1	Acceleration/Deceleration Time	201	L2	Power Loss Ride-Thru	211
C2	S-Curve Accel/Decel	201	L3	Stall Prevention	211
C3	Motor Slip Compensation	201	L4	Reference Detection	212
C4	Motor Torque Compensation	202	L5	Fault Restart	212
C6	Carrier Frequency	202	L6	Overtorque Detection	212
d1	Frequency Reference	203	L8	Hardware Protection	213
d2	Reference Limits	203	n1	Hunting Prevention	214
d3	Jump Frequencies	203	o1	Monitor Display Selection	214
d4	Frequency Reference Hold	204	o2	Operator Keypad Functions	214
E1	V/f Pattern	204	o3	Copy Function	215
E2	Motor Setup	205	o4	Maintenance Functions	215
H1	Digital Inputs	206	U1	Status Monitor	216
H2	Digital Outputs	207	U2	Fault Trace	217
H3	Analog Inputs	208	U4	Maintenance Monitor	217
H4	Analog Outputs	209			

B.2 Parameter Table

◆ A: Initialization Parameters

The A parameter group creates the operating environment for the drive. This includes the parameter Access Level, and Password.

No.	Name	Description	Range	Def.	Mode V/f	Addr. Hex	Pg.
A1: Initialization Parameters							
Use A1 parameters to configure the basic environment for drive operation.							
A1-01	Access Level Selection	Selects which parameters are accessible via the digital operator. 0: Operation only 2: Advanced Access Level	0, 2	2	O	101	116
A1-03	Initialize Parameters	Resets all parameters to factory default settings. (Initializes the drive then returns A1-03 to 0) 0: No Initialize 2220: 2-Wire Initialization 3330: 3-Wire Initialization	0 to 3330	0	O	103	87
A1-04	Password 1	When the value set into A1-04 does not match the value set into A1-05, parameters A1-01 and A1-03 cannot be changed.	0 to 9999	0	O	104	116
A1-05	Password 2		0 to 9999	0	O	105	116
This parameter is hidden from view. To access A1-05, first display A1-04. Then press the STOP key while holding down the up arrow key. Parameter A1-05 will appear.							

<2> Parameter can be changed during run.

◆ b: Application

Application parameters configure the Run Command Source, DC Injection Braking, and other application-related settings.

No.	Name	Description	Range	Def.	Mode V/f	Addr. Hex	Pg.
b1: Operation Mode Selection							
Use b1 parameters to configure the operation mode.							
b1-01	Frequency Reference Selection	Selects the frequency reference input source. 0: Operator - Digital preset speed d1-01 to d1-17 1: Terminals - Analog input terminal 2: MEMOBUS/Modbus communications (option) 3: Potentiometer (option)	0 to 3	1	S	180	87
b1-02	Run Command Selection	Selects the run command input source. 0: Operator - RUN and STOP keys on the digital operator 1: Digital input terminals 2: MEMOBUS/Modbus communications (option)	0 to 2	1	S	181	89

B.2 Parameter Table

No.	Name	Description	Range	Def.	Mode	Addr. Hex	Pg.
					V/f		
b1-03	Stopping Method Selection	Selects the stopping method when the run command is removed. 0: Ramp to Stop 1: Coast to Stop	0, 1	0	S	182	91
b1-04	Reverse Operation Selection	Permits or prohibits reverse operation. 0: Reverse enabled. 1: Reverse disabled.	0, 1	0	O	183	—
b1-07	LOCAL/REMOTE Run Selection	Determines the operation when the Run command source is switched from LOCAL to REMOTE or between Run source 1 and 2 while an external Run command is active at the new source. 0: External Run command has to be cycled at the new source to be activated. 1: External Run command at new source is accepted immediately.	0, 1	0	O	186	—
b1-08	Run Command Selection while in Programming Mode	0: Run command accepted only in the operation menu. 1: Run command accepted in all menus. 2: Prohibit entering Programming Mode during Run	0 to 2	0	O	187	—
b1-14	Phase Order Selection	Sets the phase order for drive output terminals U/T1, V/T2 and W/T3. 0: Standard 1: Switch phase order	0, 1	0	O	1C3	—
b1-17	Run Command at Power Up	Determines the operation when a Run command is active at power up of the drive. 0: Run command not issued, needs to be cycled 1: Run command issued, motor operation start	0, 1	0	O	1C6	—
b2: DC Injection Braking							
Use b2 parameters to configure DC Injection Braking operation							
b2-02	DC Injection Braking Current	Sets the DC Injection Braking current as a percentage of the drive rated current.	0 to 75	50%	O	18A	—
b2-03	DC Injection Braking Time/DC Excitation Time at Start	Sets DC Injection Braking time at start. Disabled when set to 0.00 seconds.	0.00 to 10.00	0.00 s	O	18B	—
b2-04	DC Injection Braking Time at Stop	Sets DC Injection Braking time at stop. When b1-03 = 0, this parameter sets the amount of DC Injection time applied to the motor at the end of the decel ramp. Disabled when set to 0.00.	0.00 to 10.00	0.50 s	O	18C	—

◆ C: Tuning

C parameters are used to adjust the acceleration and deceleration times, S-curves, slip and torque compensation functions and carrier frequency selections.

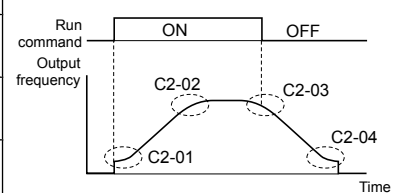
No.	Name	Description	Range	Def.	Mode V/f	Addr. Hex	Pg.
C1: Acceleration and Deceleration Times							
Use C1 parameters to configure motor acceleration and deceleration.							
C1-01 ↩	Acceleration Time 1	Sets the time to accelerate from 0 to maximum frequency.	0.0 to 6000.0	10.0 s	S	200	92
C1-02 ↩	Deceleration Time 1	Sets the time to decelerate from maximum frequency to 0.			S	201	92
C1-03 ↩	Acceleration Time 2	Sets the time to accelerate from 0 to maximum frequency when Accel/Decel times 2 are selected by a digital input.			O	202	92
C1-04 ↩	Deceleration Time 2	Sets the time to decelerate from maximum frequency to 0 when Accel/Decel times 2 are selected by a digital input.			O	203	92
C1-09	Fast-Stop Time	Sets the time to decelerate from maximum frequency to 0 for the multi-function input fast-stop function. Note: This parameter is also used by selecting “Fast-Stop” as a Stop Method when a fault is detected.			O	208	—
C2: S-Curve Characteristics							
Use C2 parameters to configure S-curve operation.							
C2-01	S-Curve Characteristic at Accel Start	<p>The S-curve can be controlled in the four points shown below.</p> 	0.00 to 10.00	0.20 s	O	20B	—
C2-02	S-Curve Characteristic at Accel End		0.00 to 10.00	0.20 s	O	20C	—
C2-03	S-Curve Characteristic at Decel Start		0.00 to 10.00	0.20 s	O	20D	—
C2-04	S-Curve Characteristic at Decel End		0.00 to 10.00	0.00 s	O	20E	—
C3: Slip Compensation							
Use C3 parameters to configure the slip compensation function.							
C3-01 ↩	Slip Compensation Gain	Sets the slip compensation gain. Decides for what amount the output frequency is boosted in order to compensate the slip. Note: Adjustment is not normally required.	0.0 to 2.5	0.0	O	20F	—
C3-02	Slip Compensation Primary Delay Time	Adjusts the slip compensation function delay time. Decrease the setting when the slip compensation response is too slow, increase it when the speed is not stable. Disabled when Simple V/f Control with PG (H6-01 = 3) is used.	0 to 10000	2000 ms	O	210	—

B.2 Parameter Table

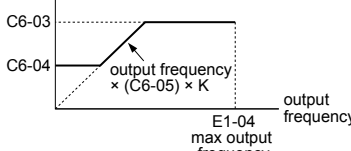
No.	Name	Description	Range	Def.	Mode V/f	Addr. Hex	Pg.
C4: Torque Compensation							
Use C4 parameters to configure Torque Compensation function.							
C4-01 <22>	Torque Compensation Gain	Sets the gain for the automatic torque (voltage) boost function and helps to produce better starting torque. Increase this setting when using a long motor cable or when the motor is significantly smaller than the drive capacity. Decrease this setting when motor oscillation occurs. Set the value so that the current at low speed does not exceeds the drive rated current.	0.00 to 2.50	1.00	O	215	—
C6: Carrier Frequency							
Use C6 parameters to configure the carrier frequency drive settings.							
C6-01	Normal/Heavy Duty Selection	Selects the load rating for the drive. 0: Heavy Duty (HD) for constant torque applications. 1: Normal Duty (ND) for variable torque applications. This setting affects the Rated output current and overload tolerance of the drive.	0, 1	1	S	223	93
C6-02	Carrier Frequency Selection	Selects the carrier frequency 1 : 2.0 kHz 2 : 5.0 kHz 3 : 8.0 kHz 4 : 10.0 kHz 5 : 12.5 kHz 6 : 15.0 kHz 7 : Swing PWM 8 to E : No setting possible F : User defined (determined by C6-03 through C6-05)	1 to F	<57>	S	224	93
C6-03	Carrier Frequency Upper Limit	C6-03 and C6-04 set upper and lower limits for the carrier frequency.	1.0 to 15.0	<8>	O	225	—
C6-04	Carrier Frequency Lower Limit	 <p>The coefficient K depends on C6-03: C6-03 ≥ 10.0 kHz: K = 3 10.0 kHz > C6-03 ≥ 5.0 kHz: K = 2 5.0 kHz > C6-03: K = 1 When C6-05 ≤ 6, C6-04 is disabled (makes the carrier frequency C6-03 value).</p>	1.0 to 15.0	<8>	O	226	—
C6-05	Carrier Frequency Proportional Gain	Sets the relationship of output frequency to carrier frequency when C6-02 = F.	00 to 99	<8>	O	227	—

<8> Default setting value is dependent on parameter C6-02, Carrier Frequency Selection.

<22> Parameter can be changed during run.

<57> Default setting value is dependent on parameter o2-04, Drive Model Selection and C6-01, Drive Duty Selection.

◆ d: References

Reference parameters are used to set the various frequency reference values during operation.

No.	Name	Description	Range	Def.	Mode	Addr.	Pg.
					V/f	Hex	
d1: Frequency Reference							
Use d1 parameters to configure the drive frequency reference.							
d1-01 ↔↔	Frequency Reference 1	Frequency reference	0.00 to 400.00 Hz ↔↔	0.00 Hz	S	280	96
d1-02 ↔↔	Frequency Reference 2	Frequency reference when digital input "Multi-Step Speed Reference 1" (H1-□□ = 3) is on.		0.00 Hz	S	281	96
d1-03 ↔↔	Frequency Reference 3	Frequency reference when digital input "Multi-Step Speed Reference 2" (H1-□□ = 4) is on.		0.00 Hz	S	282	96
d1-04 ↔↔	Frequency Reference 4	Frequency reference when digital inputs "Multi-Step Speed Reference 1, 2" (H1-□□ = 3 and 4) are on.		0.00 Hz	S	283	96
d1-05 ↔↔	Frequency Reference 5	Frequency reference when digital input "Multi-Step Speed Reference 3" (H1-□□ = 5) is on.		0.00 Hz	O	284	—
d1-06 ↔↔	Frequency Reference 6	Frequency reference when digital inputs "Multi-Step Speed Reference 1, 3" (H1-□□ = 3 and 5) are on.		0.00 Hz	O	285	—
d1-07 ↔↔	Frequency Reference 7	Frequency reference when digital inputs "Multi-Step Speed Reference 2, 3" (H1-□□ = 4 and 5) are on.		0.00 Hz	O	286	—
d1-08 ↔↔	Frequency Reference 8	Frequency reference when multi-function input "Multi-Step speed reference 1, 2, 3" (H1-□□ = 3, 4, 5) are on.		0.00 Hz	O	287	—
d1-17 ↔↔	Jog Frequency Reference	Frequency reference when digital inputs "Jog Frequency Reference", "Forward Jog" or "Reverse Jog." are on.		6.00 Hz	S	292	—
d2: Frequency Upper and Lower Limits							
Use d2 parameters to configure the frequency reference limits.							
d2-01	Frequency Reference Upper Limit	Sets the frequency reference upper limit as a percentage of maximum output frequency (E1-04). Output speed is limited to this value even if the frequency reference is higher. This limit applies to all frequency reference sources.	0.0 to 110.0	100.0 %	O	289	—
d2-02	Frequency Reference Lower Limit	Sets the frequency reference lower limit as a percentage of maximum output frequency (E1-04). Output speed is limited to this value even if the frequency reference is lower. This limit applies to all frequency reference sources.	0.0 to 110.0	0.0%	O	28A	—
d3: Jump Frequency							
Use d3 parameters to configure the drive Jump Frequency settings.							
d3-01	Jump Frequency 1	d3-01 to d3-04 allow programming of three prohibited frequency reference points for eliminating problems with resonant vibration of the motor/machine. This feature does not eliminate the selected frequency values, but accelerates and decelerates the motor through the prohibited bandwidth. The parameters must be according to the rule d3-01 ≥ d3-02 .	0.0 to 400.0	0.0 Hz	O	294	—
d3-02	Jump Frequency 2			0.0 Hz	O	295	—

B.2 Parameter Table

No.	Name	Description	Range	Def.	Mode	Addr. Hex	Pg.
					V/f		
d3-04	Jump Frequency Width	This parameter sets the dead-band width around each selected prohibited frequency reference point. The bandwidth becomes the designated Jump frequency, plus or minus d3-04.	0.0 to 20.0	1.0 Hz	O	297	—
d4: Frequency Reference Hold Use d4 parameters to configure the drive frequency reference hold function.							
d4-01	Frequency Reference Hold Function Selection	Determines if the frequency reference or frequency reference bias is saved when the Run command is removed or the power goes off. 0: Disabled 1: Enabled This parameter is effective when the multi-function inputs “Accel/Decel Ramp Hold”, “Up/Down” or “Up/Down 2” commands are selected (H1-□□ = A or 10/11).	0, 1	0	O	298	—

<19> Range upper limit is dependent on parameters E1-04, Maximum Output Frequency, and d2-01, Frequency Reference Upper Limit.

<22> Parameter can be changed during run.

◆ E: Motor Parameters

E parameters set V/f characteristics and motor-related data.

No.	Name	Description	Range	Def.	Mode	Addr. Hex	Pg.
					V/f		
E1: V/f Pattern Characteristics Use E1 parameters to set V/f characteristics for the motor.							
E1-01 <24>	Input Voltage Setting	This parameter must be set to the power supply voltage. WARNING! Drive input voltage (not motor voltage) must be set in E1-01 for the protective features of the drive to function properly. failure to do so may result in equipment damage and/or death or personal injury.	155 to 255	<14>	S	300	99
E1-03	V/f Pattern Selection	F: Custom V/f. E1-04 through E1-10 settings define the V/f pattern.	F	F	O	302	—

No.	Name	Description	Range	Def.	Mode V/f	Addr. Hex	Pg.
E1-04	Max Output Frequency	To set linear V/f characteristics, set the same values for E1-07 and E1-09. In this case, the setting for E1-08 will be disregarded. Ensure that the four frequencies are set according to these rules: $E1-04 \geq E1-06 > E1-07 \geq E1-09$ VACrms Out (V)	40.0 to 400.0	60 Hz	S	303	100
E1-05	Max Output Voltage		0.0 to 255.0	200 V	S	304	100
E1-06	Base Frequency		0.0 to E1-04	60 Hz	O	305	100
E1-07	Mid Output Frequency		0.0 to E1-04	3.0 Hz	O	306	100
E1-08	Mid Output Frequency Voltage		0.0 to 255.0	16.0 V	O	307	100
E1-09	Minimum Output Freq.		0.0 to E1-04	1.5 Hz	S	308	100
E1-10	Minimum Output Freq. Voltage		0.0 to 255.0	12.0 V	O	309	100
E2: Motor Parameters Use E2 parameters to set motor-related data.							
E2-01	Motor Rated Current	Sets the motor nameplate full load current in amperes (A).	10 to 200% of drive rated current	<57>	S	30E	103
E2-02	Motor Rated Slip	Sets the motor rated slip in Hertz.	0.00 to 20.00	<57>	O	30F	103
E2-03	Motor No-Load Current	Sets the magnetizing current of the motor in Ampere.	0 to less than E2-01	<57>	O	310	103
E2-05	Motor Line-to-Line Resistance	Sets the phase-to-phase motor resistance in ohms.	0.000 to 65.000	<57>	O	312	—

- <14> Default setting value is dependent on parameter o2-09, Initialization Spec. Selection.
- <24> Values shown here are for 200 V class drives. Double the value when using a 400 V class drive.
- <37> Setting range becomes 0.00 to 130.00 for drives 0.2 kW and smaller.
- <57> Default setting value is dependent on parameter o2-04, Drive Model Selection and C6-01, Drive Duty Selection.

B.2 Parameter Table

◆ H Parameters: Multi-Function Terminals

H parameters assign functions to the multi-function input and output terminals.

No.	Name	Description	Range	Def.	Mode	Addr. Hex	Pg.
					V/f		
H1: Multi-Function Digital Input							
H1 parameters to assign functions to the multi-function digital input terminals. Unused terminals should be set to "F".							
H1-01	Multi-Function Digital Input Terminal S1 Function Selection	Assigns a function to the multi-function digital inputs. Refer to H1 Multi-Function Digital Input Selections on page 206 for a description of setting values.	1 to 67	40	O	438	—
H1-02	Multi-Function Digital Input Terminal S2 Function Selection			41	O	439	—
H1-03	Multi-Function Digital Input Terminal S3 Function Selection		0 to 67	24	O	400	—
H1-04	Multi-Function Digital Input Terminal S4 Function Selection			14	O	401	—
H1-05	Multi-Function Digital Input Terminal S5 Function Selection			3 (0) <18>	O	402	—

<18> Parenthetical value is the default when parameter A1-03 = 3330 3-Wire Initialization.

H1 Multi-Function Digital Input Selections			
H1-□□ Setting	Function	Description	Mode
			V/f
0	3-Wire Sequence	Closed: Reverse rotation (only if the drive is set up for 3-Wire sequence)	O
1	LOCAL/REMOTE Selection	Open: REMOTE, Reference 1 (b1-01/02) Closed: LOCAL, LED operator is run and reference source	O
2	External Reference 1/2	Open: Run and frequency reference source 1 (b1-01/02) Closed: MEMOBUS/Modbus Communication	O
3	Multi-Step Speed Reference 1	Used to select Multi-Step Speeds set in d1-01 to d1-08	O
4	Multi-Step Speed Reference 2		O
5	Multi-Step Speed Reference 3		O
6	Jog Reference Selection	Open: Selected speed reference Closed: Jog Frequency reference (d1-17). Jog has priority over all other reference sources.	O
7	Accel/Decel Time 1	Used to switch between Accel/Decel Time	O
8	Baseblock Command (N.O.)	Open: Normal operation Closed: No drive output	O
9	Baseblock Command (N.C.)	Open: No drive output Closed: Normal operation	O
A	Accel/Decel Ramp Hold	Closed: The drive pauses during acceleration or deceleration and maintains the output frequency.	O
F	Not used	Select this setting when not using the terminal or when using the terminal in a pass-through mode.	O

H1 Multi-Function Digital Input Selections			
H1-□□ Setting	Function	Description	Mode
			V/f
10	Up Command	Open: Maintains the current frequency reference Closed: Increases or decreases the current frequency reference.	O
11	Down Command	Ensure that the increase and decrease commands are set in conjunction with one another.	O
14	Fault Reset	Closed: Resets faults if the cause is cleared and the Run command is removed.	O
15	Fast-Stop (N.O.)	Closed: Decelerates at the Fast-Stop time C1-09. To restart the Fast-Stop input must be released and Run must be cycled.	O
17	Fast-stop (N.C.)	Open: Decelerates according to C1-09 (Fast-stop Time)	O
20 to 2F	External Fault	20: N.O., Always Detected, Ramp To Stop 21: N.C., Always Detected, Ramp To Stop 22: N.O., During Run, Ramp To Stop 23: N.C., During Run, Ramp To Stop 24: N.O., Always Detected, Coast To Stop 25: N.C., Always Detected, Coast To Stop 26: N.O., During Run, Coast To Stop 27: N.C., During Run, Coast To Stop 28: N.O., Always Detected, Fast-stop 29: N.C., Always Detected, Fast-stop 2A: N.O., During Run, Fast-stop 2B: N.C., During Run, Fast-stop 2C: N.O., Always Detected, Alarm Only (continue running) 2D: N.C., Always Detected, Alarm Only (continue running) 2E: N.O., During Run, Alarm Only (continue running) 2F: N.C., During Run, Alarm Only (continue running)	O
40	Forward Run Command (2-Wire sequence)	Open: Stop Closed: Forward run Note: Can not be set together with Settings 42 or 43.	O
41	Reverse Run Command (2-Wire sequence)	Open: Stop Closed: Reverse run Note: Can not be set together with Settings 42 or 43.	O
61	External Search Command 1	Closed: Activates Current Detection Speed Search from the max. output frequency (E1-04) if b3-01 = 0. Activates Speed Estimation Type Speed search if b3-01 = 1.	O
62	External Search Command 2	Closed: Activates Current Detection Speed Search from the frequency reference b3-01 = 0. Activates Speed Estimation Type Speed search if b3-01 = 1.	O
67	Communications Test Mode	Tests the MEMOBUS/Modbus RS-485/422 interface.	O

No.	Name	Description	Range	Def.	Mode	Addr. Hex	Pg.
					V/f		
H2: Multi-Function Digital Outputs							
Use H2 parameters to assign functions to the multi-function digital outputs.							
H2-01	Terminal MA, MB and MC Function Selection (relay)	Refer to H2 Multi-Function Digital Output Settings on page 208 for a description of setting values.	0 to 13D	E	O	40B	103

B.2 Parameter Table

H2 Multi-Function Digital Output Settings			
H2-01 Setting	Function	Description	Mode
			V/f
0	During Run	Closed: A Run command is active or voltage is output	O
1	Zero Speed	Closed: Output frequency is 0	O
2	Speed Agree 1	Closed: Output frequency equals the speed reference (plus or minus 2 Hz)	O
4	Frequency Detection 1	Closed: Output frequency is less than or equal to the value in L4-01 plus 2 Hz	O
5	Frequency Detection 2	Closed: Output frequency is greater than the value in L4-01 plus 2 Hz	O
6	Drive Ready	Closed: Drive Ready. The drive is powered up, not in a fault state, and in the Drive mode	O
7	DC Bus Undervoltage	Closed: DC bus voltage is below the Uv trip level set in L2-05	O
8	During Baseblock (N.O.)	Closed: There is no output voltage	O
B	Torque Detection 1 (N.O.)	Closed: Output current/torque exceeds the torque value set in parameter L6-02 for longer than the time set in parameter L6-03	O
E	Fault	Closed: Fault occurred (other than CPF00 and CPF01)	O
F	Not used	Set this value when the terminal is not used, or when using the terminal in the pass-through mode	O
10	Minor Fault	Closed: An alarm is triggered	O
17	Torque Detection 1 (N.C.)	Open: When the output current/torque exceeds the value set in parameter L6-02 for more time than is set in parameter L6-03	O
1A	Reverse Direction	Closed: Drive is running in the reverse direction	O
1E	Restart Enabled	Closed: An automatic restart is performed	O
3C	LOCAL/REMOTE Status	Closed: LOCAL Open: REMOTE	O
3D	Speed Search	Closed: Speed search is being executed	O
100 to 102; 104 to 108; 10B, 10E, 110, 117, 11A, 11E, 13C, 13D	H2 Parameter Functions Reversed Output Switching of 0 to 13D	Reverse the output switching of the multi-function output functions. Set the last two digits of 1□□ to reverse the output signal of that specific function Examples: Setting "108" reverses the output of "During baseblock", which is setting value 08 Setting "13C" reverses the output of "3CLOCAL/REMOTE Status", which is setting "3C"	O

No.	Name	Description	Range	Def.	Mode V/f	Addr. Hex	Pg.
H3: Analog Inputs							
Use H3 parameters to set the analog input terminals.							
H3-01	Terminal A1 Signal Level Selection	Sets the input level for terminal A1. 0: 0 to +10 V (lower limit) 1: 0 to +10 V (no lower limit) 2: 4 to 20 mA 3: 0 to 20 mA	0 to 3	0	O	410	—
H3-03 <22>	Terminal A1 Gain Setting	Sets the level of the input value when 10 V is input at terminal A1.	-999.9 to 999.9	100.0 %	O	411	—
H3-04 <22>	Terminal A1 Bias Setting	Sets the level of the input value when 0 V is input at terminal A1.	-999.9 to 999.9	0.0%	O	412	—

B.2 Parameter Table

No.	Name	Description	Range	Def.	Mode	Addr.	Pg.
					V/f	Hex	
H3-13	Analog Input Filter Time Constant	Sets the primary delay filter time constant for terminal A1 or potentiometer (optional). Used for noise filtering.	0.00 to 2.00	0.03 s	O	41B	—

<22> Parameter can be changed during run.

No.	Name	Description	Range	Def.	Mode	Addr.	Pg.
					V/f	Hex	
H4: Multi-Function Analog Outputs							
Use H4 parameters to configure the multi-function analog output terminals.							
H4-01	Multi-Function Analog Output Terminal AM	Selects the data to be output through multi-function analog output terminal AM. Set the desired monitor parameter to the digits available in U□-□□. For example, enter "103" for U1-03. When using this terminal in through mode or when not using it at all, set "000" or "031".	000 to 999	102	O	41D	104
H4-02 <22>	Multi-Function Analog Output Terminal AM Gain	Sets terminal AM output level when selected monitor is at 100%. Maximum output voltage is 10 V.	-999.9 to 999.9	100.0 %	S	41E	104
H4-03 <22>	Multi-Function Analog Output Terminal AM Bias	Sets terminal AM output level when selected monitor is at 0%.	-999.9 to 999.9	0.0%	O	41F	104
H5: MEMOBUS/Modbus Communications							
Use H5 Parameters to connect the drive to a MEMOBUS/Modbus network.							
H5-01 <39>	Drive Slave Address	Selects drive slave number (address) for MEMOBUS/Modbus terminals R+, R-, S+, S-. Cycle power for the setting to take effect.	0 to FF	1F	O	425	—
H5-02	Comm. Speed Selection	Selects the baud rate for MEMOBUS/Modbus terminals R+, R-, S+ and S-. Cycle power for the setting to take effect. 0 : 1200 bps 1 : 2400 bps 2 : 4800 bps 3 : 9600 bps 4 : 19200 bps 5 : 38400 bps	0 to 5	3	O	426	—
H5-03	Comm. Parity Selection	Selects the communication parity for MEMOBUS/Modbus terminals R+, R-, S+ and S-. Cycle power for the setting to take effect. 0: No parity 1: Even parity 2: Odd parity	0 to 2	0	O	427	—
H5-04	Stopping Method After Comm. Error	Selects the stopping method when a communication time-out fault (CE) is detected. 0: Ramp to stop 1: Coast to stop 2: Fast-stop 3: Alarm only	0 to 3	3	O	428	—

B.2 Parameter Table

No.	Name	Description	Range	Def.	Mode	Addr. Hex	Pg.
					V/f		
H5-05	Comm. Fault Detection Selection	Enables or disables the communications timeout fault (CE). 0: Disabled - A communication loss will not cause a communication fault. 1: Enabled - If communication is lost for more than 2 seconds, a CE fault will occur.	0, 1	1	O	429	—
H5-06	Drive Transmit Wait Time	Set the wait time between receiving and sending data.	10 to 65	10 ms	O	42A	—
H5-07	RTS Control Selection	Selects "request to send" (RTS) control: 0: Disabled - RTS is always on. 1: Enabled - RTS turns on only when sending.	0, 1	1	O	42B	—
H5-12	Run Command Method Selection	0: FWD/STOP, REV/STOP Method 1: RUN/STOP, FWD/REV Method	0, 1	0	O	43D	—
H5-13	MEMOBUS Freq. Reference and Freq. Monitor Unit	0: 0.1 Hz/1 1: o1-03 based 2: 100%/30000 3: 0.1%/1	0 to 3	0	O	43E	—

<22> Parameter can be changed during run.

<39> If this parameter is set to 0, the drive will be unable to respond to MEMOBUS/Modbus commands.

Note: Cycle power to the drive to enable MEMOBUS/Modbus settings.

◆ L: Protection Function

L parameters provide protection to the drive and motor, such as: control during momentary power loss, Stall Prevention, frequency detection, fault restarts, overtorque detection, and other types of hardware protection.

No.	Name	Description	Range	Def.	Mode	Addr. Hex	Pg.
					V/f		
L1: Motor Protection Functions							
Use L1 parameters to configure motor protective functions.							
L1-01	Motor Overload Protection Selection	Sets the motor thermal overload protection (oL1) based on the cooling capacity of the motor. 0: Disabled 1: Standard Fan Cooled (speed range < 10:1) 2: Standard Blower Cooled (speed range ≥ 10:1) NOTICE: When multiple motors are used the drive may not be able to provide protection, even if it is enabled in L1-01. Set L1-01 to "0" and ensure each motor has a thermal relay installed.	0 to 2	1	S	480	105
L1-02	Motor Overload Protection Time	Sets the motor thermal overload protection (oL1) time. A larger L1-02 time will increase the time for an oL1 fault to occur. This parameter does not typically require adjustment. Should be set in accordance with the overload tolerance of the motor.	0.1 to 5.0	1.0 min	O	481	105

No.	Name	Description	Range	Def.	Mode	Addr.	Pg.
					V/f	Hex	
L1-13	Continuous Electrothermal Operation Selection	Determines whether or not to hold the electrothermal value when the power supply is interrupted. 0: Disabled 1: Enabled	0, 1	1	O	46D	—
L2: Momentary Power Loss							
Use L2 parameters to configure drive functions for momentary power loss conditions.							
L2-01	Momentary Power Loss Operation Selection	Enables and disables the momentary power loss function. 0: Disabled - Drive trips on (Uv1) fault when power is lost. 1: Power Loss Ride-Thru Time - Drive will restart if power returns within the Power Loss Ride-Thru Time. 2: CPU Power Active - Drive will restart if power returns as long as the CPU is working.	0 to 2	0	O	485	—
L3: Stall Prevention Function							
Use L3 parameters to configure the Stall Prevention function.							
L3-01	Stall Prevention Selection during Acceleration	Selects the Stall Prevention method used to prevent excessive current during acceleration. 0: Disabled - Motor accelerates at active acceleration rate. The motor may stall if load is too heavy or accel time is too short. 1: General Purpose - When output current exceeds L3-02 level, acceleration stops. Acceleration will continue when the output current level falls below the L3-02 level.	0, 1 <6>	1	O	48F	—
L3-02	Stall Prevention Level during Acceleration	Used when L3-01 = 1. 100% is equal to the drive rated current. Decrease the set value if stalling or excessive current occurs with default setting.	0 to 150	<7>	O	490	—
L3-04	Stall Prevention Selection during Deceleration	When using a braking resistor, use setting "0". Setting "3" is used in specific applications. 0: Disabled - The drive decelerates at the active deceleration rate. If the load is too large or the deceleration time is too short, an ov fault may occur. 1: General Purpose - The drive decelerates at the active deceleration rate, but if the main circuit DC bus voltage reaches the Stall Prevention level, deceleration will stop. Deceleration will continue once the DC bus level drops below the Stall Prevention level. 4: Overexcitation Deceleration - Decelerates with the flux level determined by n3-13 (Overexcitation Gain).	0, 1, 4	1	S	492	—
L3-05	Stall Prevention Selection during Run	Selects the Stall Prevention method to use to prevent drive faults during run. 0: Disabled - Drive runs a set frequency. A heavy load may cause the drive to trip on an oC or oL fault. 1: Decel Time 1 - The drive will decelerate at Decel Time 1 (C1-02) if the output current exceeds the level set by L3-06. Once the current level drops below the L3-06 level, the drive will accelerate back to its frequency reference at the active acceleration rate. 2: Decel Time 2 - Same as setting 1 except the drive decelerates at Decel Time 2 (C1-04). When output frequency is 6 Hz or less, Stall Prevention during run is disabled regardless of the setting in L3-05.	0 to 2	1	O	493	—

B.2 Parameter Table

No.	Name	Description	Range	Def.	Mode	Addr.	Pg.
					V/f	Hex	
L3-06	Stall Prevention Level during Run	Enabled when L3-05 is set to "1" or "2". 100% is equal to the drive rated current. Decrease the set value if stalling or excessive current occurs with the default settings. Upper level is determined by C6-01 and L8-38.	30 to 150	<>	O	494	—
L4: Frequency Detection Use L4 parameters to configure frequency detection operation.							
L4-01	Speed Agreement Detection Level	These parameters configure the multi-function output (H2-01 = 2, 4, 5) settings "Speed Agree 1", "User Set Speed Agree 1", "Frequency Detection 1," and "Frequency detection 2". Parameter L4-01 sets the level while parameter L4-02 sets the hysteresis for the Speed Detection Output Function.	0.0 to 400.0	0.0 Hz	O	499	—
L4-07	Frequency Detection Conditions	0: No detection during baseblock. 1: Detection always enabled.	0, 1	0	O	470	—
L5: Fault Reset Use L5 parameters to configure Automatic Restart after fault.							
L5-01	Number of Auto Restart Attempts	Sets the counter for the number of times the drive attempts to restart when one of the following faults occurs: oC, ov, PF, rH, rr, oL1, oL2, oL3, Uv1. When the drive operates without fault for 10 minutes, the counter will be reset.	0 to 10	0	O	49E	—
L6: Overtorque Detection Use L6 parameters to configure overtorque detection.							
L6-01	Torque Detection Selection 1	Selects the overtorque operation. Overtorque is determined by the settings in parameters L6-02 and L6-03. The multi-function output settings (H2-01= B and 17) are also active if programmed. 0: Disabled 1: oL3 at Speed Agree - Alarm (overtorque detection only active during Speed Agree and operation continues after detection). 2: oL3 at RUN - Alarm (overtorque detection is always active and operation continues after detection). 3: oL3 at Speed Agree - Fault (overtorque detection only active during Speed Agree and drive output will shut down on an oL3 fault). 4: oL3 at RUN - Fault (overtorque detection is always active and drive output will shut down on an oL3 fault).	0 to 4	0	O	4A1	—
L6-02	Torque Detection Level 1	Sets the overtorque detection level. 100% is equal to the motor rated current.	0 to 300	150%	O	4A2	—
L6-03	Torque Detection Time 1	Sets the length of time an overtorque condition must exist before Torque Detection is triggered.	0.0 to 10.0	0.1 s	O	4A3	—

B.2 Parameter Table

No.	Name	Description	Range	Def.	Mode	Addr.	Pg.
					V/f	Hex	
L8: Hardware Protection							
Use L8 parameters to configure hardware protection functions.							
L8-01	Internal Dynamic Braking Resistor Protection Selection (ERF type)	Selects the Braking resistor when using a 3% duty cycle heatsink mounted braking resistor. This parameter does not enable or disable the braking transistor of the drive. 0: Resistor overheat protection disabled 1: Resistor overheat protection enabled	0, 1	0	O	4AD	—
L8-05	Input Phase Loss Protection Selection	Selects the detection of input current phase loss, power supply voltage imbalance, or main circuit electrolytic capacitor deterioration. 0: Disabled 1: Enabled	0, 1	0	O	4B1	—
L8-10	Heatsink Cooling Fan Operation Selection	Controls the heatsink cooling fan operation. 0: Fan On-Run Mode - Fan will operate only when the drive is running and for L8-11 seconds after stop. 1: Fan always on - Cooling fan operates whenever the drive is powered up.	0, 1	0	O	4B6	—
L8-12	Ambient Temperature Setting	Used to input the ambient temperature. This value adjusts the drive oL2 detection level.	-10 to 50	30 °C	O	4B8	—
L8-18	Soft CLA Selection	Selects the software current limit function. Typically no adjustment is required. 0: Disabled 1: Enabled	0, 1	1	O	4BE	—
L8-35	Installation Method Selection	Selects the installation type: 0: Standard installation of Open Chassis drive 1: Side-by-Side installation with top cover removed 2: Standard Installation of NEMA Type 1 drive 3: Finless / Fin outside installation	0 to 3	0	O	4ECH	—
L8-38	Carrier Frequency Reduction	Provides protection to the IGBTs by reducing the carrier frequency at low speeds. 0: Disabled 1: Enabled below 6 Hz 2: Enabled for the whole speed range	0 to 2	<12>	O	4EF	—

<7> Default setting value is 120% when C6-01 is set to 1 (ND) and 150% when C6-01 is set to 0 (HD).

<12> Default setting value is dependent on parameter o2-04, Drive Model Selection.

<63> When enabled, the drive stops accelerating when it exceeds the value of L3-02, Stall Prevention Level. The drive decelerates after 100 ms and begins accelerating again after restoring the current level.

B.2 Parameter Table

◆ n: Advanced Performance Set-Up

The n parameters are used to adjust more advanced performance characteristics.

No.	Name	Description	Range	Def.	Mode V/f	Addr. Hex	Pg.
n1: Hunting Prevention Use n1 parameters to configure hunting prevention operation.							
n1-02	Hunting Prevention Gain Setting	Sets the gain for the Hunting Prevention Function. If the motor vibrates while lightly loaded and n1-01 = 1, increase the gain by 0.1 until vibration ceases. If the motor stalls while n1-01 = 1, decrease the gain by 0.1 until the stalling ceases.	0.00 to 2.50	1.00	O	581	—
n3: High-Slip Braking Use n3 parameters to configure the high-slip braking function.							
n3-13	Overexcitation Deceleration Gain	Applies a gain to the V/f pattern during deceleration (L3-04 = 4). Returns to normal values after ramp to stop or at re-acceleration. To increase the braking power of overexcitation, increase the gain by 1.25 to 1.30.	1.00 to 1.40	1.10	O	531	—

◆ o: Operator Related Parameters

o parameters are used to set up the LED digital operator displays.

No.	Name	Description	Range	Def.	Mode V/f	Addr. Hex	Pg.
o1: Display Settings Use o1 parameters to configure the digital operator display.							
o1-02 <2>	User Monitor Selection After Power Up	Selects the monitor to display upon power-up. 1: Frequency Reference (U1-01) 2: Forward/Reverse 3: Output Frequency (U1-02) 4: Output Current (U1-03)	1 to 4	1	O	501	—
o1-03	Digital Operator Display Selection	Sets the units to display the frequency reference and output frequency. 0: 0.01 Hz 1: 0.01% (100% = E1-04)	0, 1	0	O	502	—
o2: Operator Keypad Functions Use o2 parameters to configure LED digital operator key functions.							
o2-02	STOP Key Function Selection	Determines if the STOP key on the digital operator will stop the drive when operating from the external terminals or via serial communication. 0: Disabled 1: Enabled	0, 1	1	O	506	—
o2-04	Drive Model Selection	Sets the drive model. This parameter only needs to be set when installing a new control board. Do not change for other reason.	0 to FF	dep. on drive spec.	O	508	—

B.2 Parameter Table

No.	Name	Description	Range	Def.	Mode	Addr.	Pg.
					V/f	Hex	
o2-05	Frequency Reference Setting Method Selection	Selects if the ENTER key must be pressed when inputting the frequency reference by the operator keypad. 0: Data/Enter key must be pressed to enter a frequency reference. 1: Data/Enter key is not required. The frequency reference is adjusted by the UP and DOWN keys.	0, 1	0	O	509	—
o2-09	Initialization mode	(Maker setting)	0 to 3	dep. on drive spec.	O	50D	—
o3: Copy Function							
Use o3 parameters to Read, Copy and Verify the parameter settings to and from the drive.							
o3-01	Copy Function Selection	Changes some parameter default settings depending on the region. This parameter controls the copying of parameters to and from the LED operator (option). 0: COPY SELECT (no function) 1: INV --> OP READ - All parameters are copied from the drive to the LED operator. 2: OP --> INV WRITE - All parameters are copied from the LED operator to the drive. 3: OP<->INV VERIFY - Parameter settings in the drive are compared to those in the LED operator. NOTE: When using the copy function, the drive model number (o2-04) and the software number (U1-14) must match or an error will occur.	0 to 3	0	O	515	—
o3-02	Copy Allowed Selection	Enables and disables the digital operator copy functions. 0: Disabled - No digital operator copy functions are allowed. 1: Enabled - Copying allowed.	0, 1	0	O	516	—
o4: Maintenance Period							
Use o4 parameters to perform maintenance.							
o4-01	Accumulated Operation Time Setting	Sets the value for the cumulative operation time of the drive in units of 10 h.	0 to 9999	0	O	50B	—
o4-02	Accumulated Operation Time Selection	Determines, how the cumulative operation time (U4-01) is counted. 0: Logs power-on time 1: Logs operation time when the drive output is active (output operation time).	0, 1	0	O	50C	—
o4-03	Cooling Fan Operation Time Setting	Sets the value of the fan operation time monitor U4-03 in units of 10 h.	0 to 9999	0	O	50E	—
o4-05	Capacitor Maintenance Setting	Sets the value of the capacitor maintenance time monitor U4-05.	0 to 150	0%	O	51D	—
o4-07	Soft Charge Bypass Relay Maintenance Setting	Sets the value of the Soft Charge Bypass Relay Maintenance monitor U4-06.	0 to 150	0%	O	523	—

B.2 Parameter Table

No.	Name	Description	Range	Def.	Mode	Addr.	Pg.
					V/f	Hex	
o4-09	IGBT Maintenance Setting	Sets the value of the IGBT Maintenance monitor U4-07.	0 to 150	0%	O	525	—
o4-11	U2 Initialize Selection	Selects if U2-□□ (Fault Trace) monitors are reset at drive initialization. 0: Saves the fault monitor data 1: Resets the fault monitor data	0, 1	0	O	510	—







<12> Default setting value is dependent on parameter o2-04, Drive Model Selection.

<22> Parameter can be changed during run.



<61> Valid for drive software 1011 and later. Value is set in 1 h units for older software.

◆ U: Monitors

Monitor parameters allow the user to view drive status, fault information, and other information about drive operation.

No.	Name	Description	Analog Output Level	Unit	Mode	Addr.
					V/f	Hex
U1: Operation Status Monitors						
Use U1 monitors to display the operation status of the drive.						
U1-01	Frequency Reference	Monitors the frequency	10 V: Max frequency	0.01 Hz	O	40
U1-02	Output Frequency	Displays the output frequency. Display units are determined by o1-03.	10 V: Max frequency	0.01 Hz	O	41
U1-03	Output Current	Displays the output current.	10 V: Drive rated current	0.01 A	O	42
U1-06	Output Voltage Reference	Displays the output voltage.	10 V: 200 Vrms (400 Vrms)	0.1 V	O	45
U1-07	DC Bus Voltage	Displays the DC bus voltage.	10 V: 400 V (800 V)	1 V	O	46
U1-10	Input Terminal Status	Displays the input terminal status.  <ul style="list-style-type: none">  Digital input terminal S1 enabled  Digital input terminal S2 enabled  Digital input terminal S3 enabled  Digital input terminal S4 enabled  Digital input terminal S5 enabled 	No output signal available	—	O	49

B.2 Parameter Table

No.	Name	Description	Analog Output Level	Unit	Mode	Addr. Hex
					V/f	
U1-11	Output Terminal Status	Displays the output terminal status.  <ul style="list-style-type: none">  Multi-Function Digital Output (fault) (terminal MA/MB-MC) 	No output signal available	–	O	4A
U1-13	Terminal Input Level	Displays analog input A1 level: 100% when input is 10 V.	10 V: 100%	0.1%	O	4E
U1-19	MEMOBUS/Modbus Error Code	Displays the contents of a MEMOBUS/Modbus error.  <ul style="list-style-type: none">  CRC Error  Data Length Error  Not Used  Parity Error  Overrun Error  Framing Error  Timed Out  Not Used 	No output signal available	–	O	66
U1-25	Software No. (ROM)	ROM ID	No signal output avail.	–	O	4D
U1-26	Software No. (Flash)	Flash ID	No signal output avail.	–	O	5B
U2: Fault Trace Use U2 monitor parameters to view fault trace data.						
U2-01	Current Fault	Display of the current fault.	No signal output avail.	–	O	80
U2-02	Previous Fault	Display of the previous fault. o4–11 resets the values for U2–02	No signal output avail.	–	O	81
U4: Maintenance Monitors Use U4 parameters to display drive maintenance information.						
U4-01	Accumulated Operation Time	Displays the cumulative operation time of the drive. The value for the cumulative operation time counter can be reset in parameter o4-01. Use parameter o4-02 to determine if the operation time should start as soon as the power is switched on or only while the run command is present. The maximum number displayed is 99999, after which the value is reset to 0.	No signal output avail.	1 h	O	4C
U4-04	Cooling Fan Maintenance	Displays main cooling fan usage time in as a percentage of their expected performance life. Parameter o4-03 can be used to reset this monitor.	No signal output avail.	1%	O	7E

B.2 Parameter Table

No.	Name	Description	Analog Output Level	Unit	Mode	Addr.
					V/f	Hex
U4-05	Capacitor Maintenance	Displays main circuit capacitor usage time in as a percentage of their expected performance life. Parameter o4-05 can be used to reset this monitor.	No signal output avail.	1%	O	7C
U4-06	Soft Charge Bypass Relay Maintenance	Displays the soft charge bypass relay maintenance time as a percentage of the estimated product life. Parameter o4-07 can be used to reset this monitor.	No signal output avail.	1%	O	7D6
U4-07	IGBT Maintenance	Displays IGBT usage time as a percent of expected performance life. Parameter o4-09 can be used to reset this monitor.	No signal output avail.	1%	O	7D7
U4-08	Heatsink Temperature	Displays the heatsink temperature.	10 V: 100 °C	1 °C	O	68
U4-09	LED Check	Lights all segments of the LED to verify that the display is working properly.	No signal output avail.	–	O	3C
U4-13	Peak Hold Current	Displays the peak hold current during run.	10 V: Motor rated current	0.01 A	O	7CF

B.3 Defaults Determined by Drive Capacity (o2-04) and ND/HD (C6-01)

Table B.1 Single-Phase, 200 V Class Drives Default Settings by Drive Capacity and ND/HD Settings

No.	Description	Unit	Default Settings					
			BA0001		BA0002		BA0003	
–	Model CIMR-J□	–	BA0001		BA0002		BA0003	
C6-01	Normal/Heavy Duty	–	HD	ND	HD	ND	HD	ND
o2-04	Drive Model Selection	Hex	30		31		32	
–	Motor rated power	kW	0.1	0.2	0.2	0.4	0.4	0.75
C6-02	Carrier frequency	–	4	7	4	7	4	7
E2-01	Motor rated current	A	0.60	1.10	1.10	1.90	1.90	3.30
E2-02	Motor rated slip	Hz	2.50	2.60	2.60	2.90	2.90	2.50
E2-03	Motor no-load current	A	0.40	0.80	0.80	1.20	1.20	1.80
E2-05	Motor line-to-line resistance	Ω	35.98	20.56	20.56	9.842	9.842	5.156
–	Momentary power loss ride-through time	s	0.1	0.1	0.1	0.1	0.1	0.1
–	Mom. power loss Baseblock time	s	0.2	0.2	0.2	0.2	0.2	0.3

No.	Description	Unit	Default Settings			
			BA0006		BA0010	
–	Model CIMR-J□	–	BA0006		BA0010	
C6-01	Normal/Heavy Duty	–	HD		ND	
o2-04	Drive Model Selection	Hex	33		34	
C6-02	Carrier frequency	–	4	7	3	7
E2-01	Motor rated current	A	3.30	6.20	6.20	8.50
E2-02	Motor rated slip	Hz	2.50	2.60	2.60	2.90
E2-03	Motor no-load current	A	1.80	2.80	2.80	3.00
E2-05	Motor line-to-line resistance	Ω	5.156	1.997	1.997	1.601
–	Momentary power loss ride-through time	s	0.2	0.2	0.3	0.3
–	Momentary power loss Baseblock time	s	0.3	0.4	0.4	0.5

Table B.2 Three-Phase, 200 V Class Drives Default Settings by Drive Capacity and ND/HD settings

No.	Description	Unit	Default Settings									
			2A0001		2A0002		2A0004		2A0006		2A0008	
–	Model CIMR-J□	–	2A0001		2A0002		2A0004		2A0006		2A0008	
C6-01	Normal/Heavy Duty	–	HD	ND	HD	ND	HD	ND	HD	ND	HD	ND
o2-04	Drive Model Selection	–	96 (60H)		97 (61H)		98 (62H)		99 (63H)		100 (64H)	
–	Motor rated power	kW	0.1	0.2	0.2	0.4	0.4	0.75	0.75	1.1	1.1	1.5
C6-02	Carrier frequency	–	4	7	4	7	4	7	4	7	3	7
E2-01	Motor rated current	A	0.60	1.10	1.10	1.90	1.90	3.30	3.30	4.90	4.90	6.20
E2-02	Motor rated slip	Hz	2.50	2.60	2.60	2.90	2.90	2.50	2.50	2.60	2.60	2.60
E2-03	Motor no-load current	A	0.40	0.80	0.80	1.20	1.20	1.80	1.80	2.30	2.30	2.80
E2-05	Motor line-to-line resistance	Ω	35.98	20.56	20.56	9.842	9.842	5.156	5.156	3.577	3.577	1.997
L2-02	Momentary power loss ride-through time	s	0.1	0.1	0.1	0.1	0.1	0.1	0.2	0.2	0.3	0.3

B.3 Defaults Determined by Drive Capacity (o2-04) and ND/HD (C6-01)

No.	Description	Unit	Default Settings									
			2A0001		2A0002		2A0004		2A0006		2A0008	
-	Model CIMR-J□	-	HD	ND	HD	ND	HD	ND	HD	ND	HD	ND
C6-01	Normal/Heavy Duty	-	96 (60H)	97 (61H)	98 (62H)	99 (63H)	100 (64H)					
o2-04	Drive Model Selection	-	0.1	0.2	0.2	0.4	0.4	0.75	0.75	1.1	1.1	1.5
-	Motor rated power	kW	0.1	0.2	0.2	0.4	0.4	0.75	0.75	1.1	1.1	1.5
L2-03	Momentary power loss Baseblock time	s	0.2	0.2	0.2	0.2	0.2	0.3	0.3	0.4	0.4	0.4

No.	Description	Unit	Default Settings							
			2A0010		2A0012		2A0018		2A0020	
-	Model CIMR-J□	-	HD	ND	HD	ND	HD	ND	HD	ND
C6-01	Normal/Heavy Duty	-	101 (65H)	102 (66H)	103 (67H)	104 (68H)				
o2-04	Drive Model Selection	-	1.5	2.2	2.2	3.0	3.0	3.7	3.7	5.5
-	Motor rated power	kW	1.5	2.2	2.2	3.0	3.0	3.7	3.7	5.5
C6-02	Carrier frequency	-	3	7	3	7	3	7	3	7
E2-01	Motor rated current	A	6.20	8.50	8.50	11.40	11.40	14.00	14.00	19.60
E2-02	Motor rated slip	Hz	2.60	2.90	2.90	2.70	2.70	2.73	2.73	1.50
E2-03	Motor no-load current	A	2.80	3.00	3.00	3.70	3.70	4.50	4.50	5.10
E2-05	Motor line-to-line resistance	Ω	1.997	1.601	1.601	1.034	1.034	0.771	0.771	0.399
L2-02	Momentary power loss ride-through time	s	0.3	0.3	0.5	0.5	1	1	1	1
L2-03	Momentary power loss Baseblock time	s	0.4	0.5	0.5	0.5	0.5	0.6	0.6	0.7

Table B.3 Three-Phase 400 V Class Drives Default Settings by Drive Capacity and ND/HD Setting

No.	Description	Unit	Default Settings							
			4A0001		4A0002		4A0004		4A0005	
-	Model CIMR-J□	-	HD	ND	HD	ND	HD	ND	HD	ND
C6-01	Normal/Heavy Duty	-	91	92	93	94				
o2-04	Drive Model Selection	Hex	0.2	0.4	0.4	0.75	0.75	1.5	1.5	2.2
-	Motor rated power	kW	0.2	0.4	0.4	0.75	0.75	1.5	1.5	2.2
C6-02	Carrier frequency	-	3	7	3	7	3	7	3	7
E2-01	Motor rated current	A	0.60	1.00	1.00	1.60	1.60	3.10	3.10	4.20
E2-02	Motor rated slip	Hz	2.50	2.90	2.90	2.60	2.60	2.50	2.50	3.00
E2-03	Motor no-load current	A	0.40	0.60	0.60	0.80	0.80	1.40	1.40	1.50
E2-05	Motor line-to-line resistance	Ω	83.94	38.198	38.198	22.459	22.459	10.1	10.1	6.495
L2-02	Momentary power loss ride-through time	s	0.1	0.1	0.1	0.1	0.2	0.2	0.3	0.3
L2-03	Momentary power loss Baseblock time	s	0.2	0.2	0.2	0.3	0.3	0.4	0.4	0.5

No.	Description	Unit	Default Setting					
			4A0007		4A0009		4A0011	
-	Model CIMR-J□	-	HD	ND	HD	ND	HD	ND
C6-01	Normal/Heavy Duty	-	95	96	97			
o2-04	Drive Model Selection	-	2.2	3.0	3.0	3.7	4.0	5.5
-	Motor rated power	kW	2.2	3.0	3.0	3.7	4.0	5.5
C6-02	Carrier frequency	-	3	7	3	7	3	7

B.3 Defaults Determined by Drive Capacity (o2-04) and ND/HD (C6-01)

No.	Description	Unit	Default Setting					
			4A0007		4A0009		4A0011	
-	Model CIMR-J□	-	HD	ND	HD	ND	HD	ND
C6-01	Normal/Heavy Duty	-	HD	ND	HD	ND	HD	ND
o2-04	Drive Model Selection	-	95		96		97	
-	Motor rated power	kW	2.2	3.0	3.0	3.7	4.0	5.5
E2-01	Motor rated current	A	4.20	5.70	5.70	7.00	7.00	9.80
E2-02	Motor rated slip	Hz	3.00	2.70	2.70	2.70	2.70	1.50
E2-03	Motor no-load current	A	1.50	1.90	1.90	2.30	2.30	2.60
E2-05	Motor line-to-line resistance	Ω	6.495	4.360	4.360	3.333	3.333	1.595
L2-02	Momentary power loss ride-through time	s	0.5	0.5	0.5	0.5	0.5	0.5
L2-03	Momentary power loss Baseblock time	s	0.5	0.5	0.5	0.6	0.6	0.7

B.4 Defaults Determined by Carrier Frequency Selection (C6-02)

Table B.4 Defaults Determined by Carrier Frequency Selection (C6-02)

C6-02		C6-03	C6-04	C6-05
Setting	Description	Default Setting		
1	2.0 kHz	2.0	2.0	0
2	5.0 kHz	5.0	5.0	0
3	8.0 kHz	8.0	8.0	0
4	10.0 kHz	10.0	10.0	0
5	12.5 kHz	12.5	12.5	0
6	15.0 kHz	15.0	15.0	0
7	Swing PWM	2.0	2.0	0
8 to E	Reserved	—	—	—
F	User Setting determined by C6-03 through C6-05	User Setting	User Setting	User Setting

B.5 Defaults Determined by Carrier Frequency Reduction (L8-38)

Table B.5 Defaults Determined by Carrier Frequency Reduction (L8-38)

No.	Name	Min.	Default Setting (L8-38)					
			0		1		2	
			HD	ND	HD	ND	HD	ND
L3-02	Stall Prevention Level during Acceleration	1	Current derating value x 1.5	Current derating value x 1.2	150	120	150	120
L3-06	Stall Prevention Level during Run	1	Current derating value x 1.5	Current derating value x 1.2	150	120	150	120

This Page Intentionally Blank



Appendix: C

Standards Compliance

This appendix explains the guidelines and criteria for maintaining CE and UL standards.

C.1 SECTION SAFETY.....	226
C.2 EUROPEAN STANDARDS.....	229
C.3 UL STANDARDS.....	236

C.1 Section Safety

DANGER

Electrical Shock Hazard

Do not connect or disconnect wiring while the power is on.

Failure to comply will result in death or serious injury.

WARNING

Electrical Shock Hazard

Do not operate equipment with covers removed.

Failure to comply could result in death or serious injury.

The diagrams in this section may show drives without covers or safety shields to show details. Be sure to reinstall covers or shields before operating the drives and run the drives according to the instructions described in this manual.

Always ground the motor-side grounding terminal.

Improper equipment grounding could result in death or serious injury by contacting the motor case.

Do not touch any terminals before the capacitors have fully discharged.

Failure to comply could result in death or serious injury.

Before wiring terminals, disconnect all power to the equipment. The internal capacitor remains charged even after the power supply is turned off. The charge indicator LED will extinguish when the DC bus voltage is below 50 Vdc. To prevent electric shock, wait at least one minute after all indicators are off and measure the DC bus voltage level to confirm safe level.

WARNING

Do not allow unqualified personnel to perform work on the drive.

Failure to comply could result in death or serious injury.

Installation, maintenance, inspection, and servicing must be performed only by authorized personnel familiar with installation, adjustment and maintenance of AC drives.

 **WARNING**

Do not perform work on the drive while wearing loose clothing, jewelry or without eye protection.

Failure to comply could result in death or serious injury.

Remove all metal objects such as watches and rings, secure loose clothing, and wear eye protection before beginning work on the drive.

Do not remove covers or touch circuit boards while the power is on.

Failure to comply could result in death or serious injury.

 **WARNING****Fire Hazard**

Tighten all terminal screws to the specified tightening torque.

Loose electrical connections could result in death or serious injury by fire due to overheating of electrical connections.

Do not use an improper voltage source.

Failure to comply could result in death or serious injury by fire.

Verify that the rated voltage of the drive matches the voltage of the incoming power supply before applying power.

Do not use improper combustible materials.

Failure to comply could result in death or serious injury by fire.

Attach the drive to metal or other noncombustible material.

NOTICE

Observe proper electrostatic discharge procedures (ESD) when handling the drive and circuit boards.

Failure to comply may result in ESD damage to the drive circuitry.

Never connect or disconnect the motor from the drive while the drive is outputting voltage.

Improper equipment sequencing could result in damage to the drive.

Do not use unshielded cable for control wiring.

Failure to comply may cause electrical interference resulting in poor system performance. Use shielded twisted-pair wires and ground the shield to the ground terminal of the drive.

Do not allow unqualified personnel to use the product.

Failure to comply could result in damage to the drive or braking circuit.

Carefully review instruction manual TOBPC72060000 when connecting a braking option to the drive.

Do not modify the drive circuitry.

Failure to comply could result in damage to the drive and will void warranty.

Yaskawa is not responsible for modification of the product made by the user. This product must not be modified.

Check all the wiring to ensure that all connections are correct after installing the drive and connecting other devices.

Failure to comply could result in damage to the drive.

C.2 European Standards



Figure C.1 CE Mark

The CE mark indicates compliance with European safety and environmental regulations and is required for engaging in business and commerce in Europe.

European standards include the Machinery Directive for machine manufacturers, the Low Voltage Directive for electronics manufacturers and the EMC guidelines for controlling noise.

This drive displays the CE mark based on the EMC guidelines and the Low Voltage Directive.

- **EMC Guidelines:** 2004/108/EC
- **Low Voltage Directive:** 2006/95/EC

◆ CE Low Voltage Directive Compliance

This drive has been tested according to IEC61800-5-1:2007, and it fully complies with the Low Voltage Directive.

To comply with the Low Voltage Directive, be sure to meet the following conditions when combining this drive with other devices:

■ Area of Use

Do not use drives in areas with pollution higher than severity 2 and overvoltage category 3 in accordance with IEC664.

■ Installing Fuses on the Input Side

Install recommended UL-approved fuses at the main power input of the drive. Select fuses according to [Table C.1](#).

Table C.1 Recommended Input Fuse Selection

Drive Model CIMR-J□	Class T Fuses		Class RK5 Fuses
	Model	Fuse Ampere Rating	
200 V Class Single-Phase Drives			
BA0001	A6T15	15	Contact Yaskawa
BA0002	A6T20	20	Contact Yaskawa
BA0003	A6T20	20	Contact Yaskawa
BA0006	A6T40	40	Contact Yaskawa

C.2 European Standards

Drive Model CIMR-J□	Class T Fuses		Class RK5 Fuses
	Model	Fuse Ampere Rating	
BA0010	A6T40	40	Contact Yaskawa
200 V Class Three-Phase Drives			
2A0001	A6T10	10	Contact Yaskawa
2A0002	A6T10	10	Contact Yaskawa
2A0004	A6T15	15	Contact Yaskawa
2A0006	A6T20	20	Contact Yaskawa
2A0008	A6T25	25	Contact Yaskawa
2A0010	A6T25	25	Contact Yaskawa
2A0012	A6T30	30	Contact Yaskawa
2A0018	A6T40	40	Contact Yaskawa
2A0020	A6T40	40	Contact Yaskawa
400 V Class Three-Phase Drives			
4A0001	A6T10	10	Contact Yaskawa
4A0002	A6T10	10	Contact Yaskawa
4A0004	A6T20	20	Contact Yaskawa
4A0005	A6T25	25	Contact Yaskawa
4A0007	A6T25	25	Contact Yaskawa
4A0009	A6T25	25	Contact Yaskawa
4A0011	A6T30	30	Contact Yaskawa

■ Grounding

The drive is designed to be used in T-N (grounded neutral point) networks. If installing the drive in other types of grounded systems, contact your dealer or Yaskawa for instructions.

◆ EMC Guidelines Compliance

This drive is tested according to IEC61800-3:2004 and it complies with the EMC guidelines.

■ EMC Filter Installation

The following conditions must be met to ensure continued compliance with guidelines. *Refer to EMC Filters on page 233* for EMC filter selection.

Installation Method

Verify the following installation conditions to ensure that other devices and machinery used in combination with this drive also comply with EMC guidelines.

1. Install an EMC noise filter to the input side specified by Yaskawa for compliance with European standards.
2. Place the drive and EMC noise filter in the same enclosure.

3. Use braided shield cable for the drive and motor wiring or run the wiring through a metal conduit.
4. Keep wiring as short as possible. Ground the shield on both the drive side and the motor side.

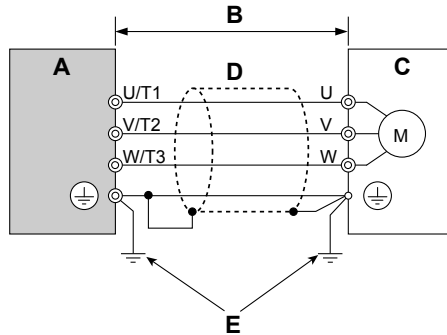

- A – Drive
 B – 20 m max cable length between drive and motor
 C – Motor
 D – Metal conduit
 E – Ground wire should be as short as possible.

Figure C.2 Installation Method

5. Ground the largest possible surface area of the shield to the metal conduit when using braided shield cable. Yaskawa recommends using a cable clamp.

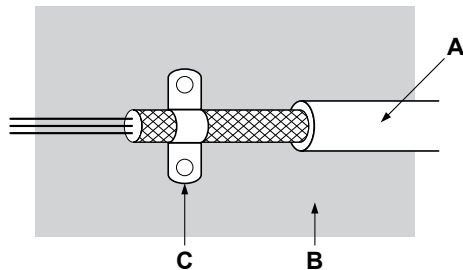

- A – Braided shield cable
 B – Metal panel
 C – Cable clamp (conductive)

Figure C.3 Ground Area

Single-Phase 200 V Class

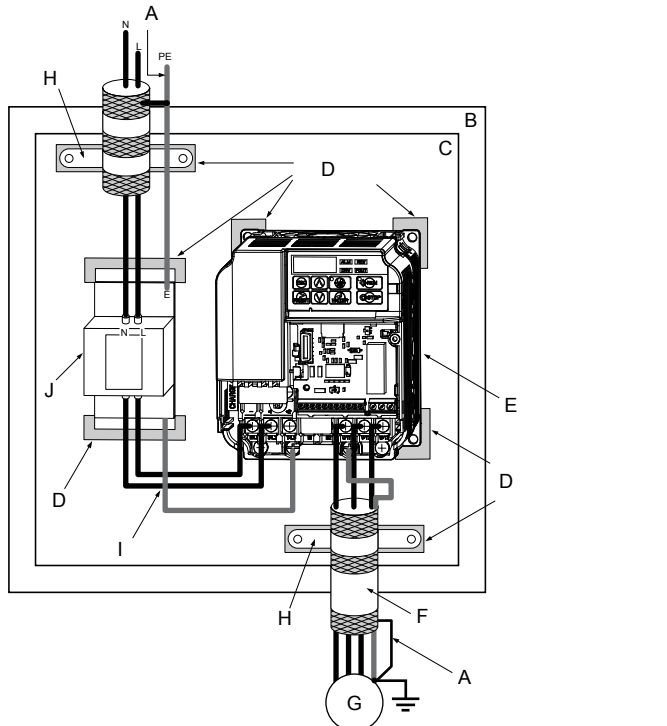

- | | |
|---|---|
| <p>A – Ground the cable shield</p> <p>B – Enclosure panel</p> <p>C – Metal plate</p> <p>D – Grounding surface (remove any paint or sealant)</p> <p>E – Drive</p> | <p>F – Motor cable (braided shield cable, max. 20 m)</p> <p>G – Motor</p> <p>H – Cable clamp</p> <p>I – Max. distance between drive and noise filter</p> <p>J – EMC noise filter</p> |
|---|---|

Figure C.5 EMC Filter and Drive Installation for CE Compliance (Single-Phase 200 V Class)

■ EMC Filters

The drive should be installed with the EMC filters listed below in order to comply with the EN 61800-3, category C1 requirements.

C.2 European Standards

Table C.2 EN 61800-3 Category C1 Filters

Drive CIMR-J□	Filter Data (Manufacturer: Schaffner)						
	Type	Rated Current (A)	Weight (kg)	Dimensions [W x L x H] (mm)	Y x X	Drive Mounting Screw A	Filter Mounting Screw
200 V Single-Phase Units							
BA0001	FS23638-10-07	10	0.44	71 x 169 x 45	51 x 156	M4	M5
BA0002	FS23638-10-07	10	0.44	71 x 169 x 45	51 x 156	M4	M5
BA0003	FS23638-10-07	10	0.44	71 x 169 x 45	51 x 156	M4	M5
BA0006	FS23638-20-07	20	0.75	111 x 169 x 50	91 x 156	M4	M5
BA0010	FS23638-20-07	20	0.75	111 x 169 x 50	91 x 156	M4	M5
200 V Three-Phase Units							
2A0001	FS23637-8-07	8	0.4	71 x 169 x 40	51 x 156	M4	M5
2A0002	FS23637-8-07	8	0.4	71 x 169 x 40	51 x 156	M4	M5
2A0004	FS23637-8-07	8	0.4	71 x 169 x 40	51 x 156	M4	M5
2A0006	FS23637-8-07	8	0.4	71 x 169 x 40	51 x 156	M4	M5
2A0008	FS23637-14-07	14	0.58	111 x 169 x 45	91 x 156	M4	M5
2A0010	FS23637-14-07	14	0.58	111 x 169 x 45	91 x 156	M4	M5
2A0012	FS23637-14-07	14	0.58	111 x 169 x 45	91 x 156	M4	M5
2A0018	FS23637-24-07	24	0.9	144 x 174 x 50	120 x 156	M4	M5
2A0020	FS23637-24-07	24	0.9	144 x 174 x 50	120 x 156	M4	M5
400 V Three-Phase Units							
4A0001	FS23639-5-07	5	0.5	111 x 169 x 45	91 x 156	M4	M5
4A0002	FS23639-5-07	5	0.5	111 x 169 x 45	91 x 156	M4	M5
4A0004	FS23639-5-07	5	0.5	111 x 169 x 45	91 x 156	M4	M5
4A0005	FS23639-10-07	10	0.7	111 x 169 x 45	91 x 156	M4	M5
4A0007	FS23639-10-07	10	0.7	111 x 169 x 45	91 x 156	M4	M5
4A0009	FS23639-10-07	10	0.7	111 x 169 x 45	91 x 156	M4	M5
4A0011	FS23639-15-07	15	0.9	144 x 174 x 50	120 x 161	M4	M5

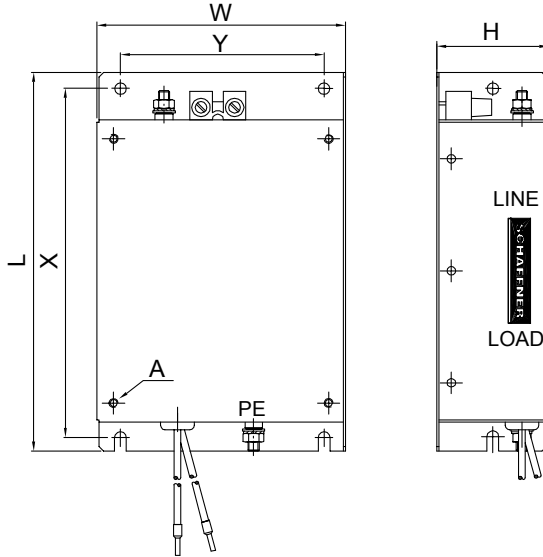

Figure C.6 EMC Filter Dimensions

■ DC Reactors for EN 61000-3-2 Compliance

Table C.3 DC Reactors for Harmonics Reduction

Drive Type CIMR-J□	DC Reactor	
	Model	Rating
200V Three-Phase Units		
2A004	UZDA-B	5.4 A
2A006		8 mH
400 V Three-Phase Units		
4A002	UZDA-B	3.2 A
4A004		28 mH

Note: Contact Yaskawa for information about DC reactors for other models.

C.3 UL Standards

The UL/cUL mark applies to products in the United States and Canada indicates that UL has performed product testing and evaluation and determined that their stringent standards for product safety have been met. For a product to receive UL certification, all components inside that product must also receive UL certification.



Figure C.7 UL/cUL Mark

◆ UL Standards Compliance

This drive is tested in accordance with UL standard UL508C, E131457 and complies with UL requirements. The following conditions must be met to maintain compliance when using this drive in combination with other equipment:

■ Installation Area

Do not install the drive to an area greater than pollution severity 2 (UL standard).

■ Main Circuit Terminal Wiring

Yaskawa recommends using UL-listed copper wires (rated at 75 °C) and closed-loop connectors or CSA-certified ring connectors sized for the selected wire gauge to maintain proper clearances when wiring the drive. Use the correct crimp tool to install connectors per manufacturer recommendation. [Table C.4](#) lists a suitable closed-loop connector manufactured by JST Corporation.

Table C.4 Closed-Loop Crimp Terminal Size (JIS C 2805) (same for 200 V and 400 V)

Wire Gauge mm ² (AWG)	Terminal Screws	Crimp Terminal Model Numbers	Tightening Torque N m (lb to in.)
0.75 (18)	M3.5	R1.25-3.5	0.8 to 1.0 (7.1 to 8.9)
	M4	R1.25-4	1.2 to 1.5 (10.6 to 13.3)
1.25 (16)	M3.5	R1.25-3.5	0.8 to 1.0 (7.1 to 8.9)
	M4	R1.25-4	1.2 to 1.5 (10.6 to 13.3)
2 (14)	M3.5	R2-3.5	0.8 to 1.0 (7.1 to 8.9)
	M4	R2-4	1.2 to 1.5 (10.6 to 13.3)
	M5	R2-5	2.0 to 2.5 (17.7 to 22.1)
	M6	R2-6	4.0 to 5.0 (35.4 to 44.3)

Wire Gauge mm ² (AWG)	Terminal Screws	Crimp Terminal Model Numbers	Tightening Torque N m (lb to in.)
3.5/5.5 (12/10)	M4	R5.5-4	1.2 to 1.5 (10.6 to 13.3)
	M5	R5.5-5	2.0 to 2.5 (17.7 to 22.1)
	M6	R5.5-6	4.0 to 5.0 (35.4 to 44.3)
	M8	R5.5-8	9.0 to 11.0 (79.7 to 97.4)
8 (8)	M4	8-4	1.2 to 1.5 (10.6 to 13.3)
	M5	R8-5	2.0 to 2.5 (17.7 to 22.1)
	M6	R8-6	4.0 to 5.0 (35.4 to 44.3)
	M8	R8-8	9.0 to 11.0 (79.7 to 97.4)
14 (6)	M4	14-4	1.2 to 1.5 (10.6 to 13.3)
	M5	R14-5	2.0 to 2.5 (17.7 to 22.1)
	M6	R14-6	4.0 to 5.0 (35.4 to 44.3)
	M8	R14-8	9.0 to 11.0 (79.7 to 97.4)
22 (4)	M6	R22-6	4.0 to 5.0 (35.4 to 44.3)
	M8	R22-8	9.0 to 11.0 (79.7 to 97.4)
30/38 (3/2)	M8	R38-8	9.0 to 11.0 (79.7 to 97.4)

Note: Use crimp insulated terminals or insulated shrink tubing for wiring connections. Wires should have a continuous maximum allowable temperature of 75 °C 600 Vac UL-approved vinyl-sheathed insulation.

Table C.5 Recommended Input Fuse Selection

Drive Model CIMR-J□	Class T Fuses 600 Vac, 200 kAIR	Fuse Ampere Rating
200 V Class Single-Phase Drives		
BA0001	A6T15	15
BA0002	A6T20	20
BA0003	A6T20	20
BA0006	A6T40	40
BA0010	A6T40	40
200 V Class Three-Phase Drives		
2A0001	A6T10	10
2A0002	A6T10	10
2A0004	A6T15	15
2A0006	A6T20	20
2A0008	A6T25	25
2A0010	A6T25	25
2A0012	A6T30	30
2A0018	A6T40	40
2A0020	A6T40	40
400 V Class Three-Phase Drives		
4A0001	A6T10	10
4A0002	A6T10	10
4A0004	A6T20	20
4A0005	A6T25	25
4A0007	A6T25	25

C.3 UL Standards

Drive Model CIMR-J□	Class T Fuses 600 Vac, 200 kAIR	Fuse Ampere Rating
4A0009	A6T25	25
4A0011	A6T30	30

■ Low Voltage Wiring for Control Circuit Terminals

Wire low voltage wires with NEC Class 1 circuit conductors. Refer to national state or local codes for wiring. Use a class 2 (UL regulations) power supply for the control circuit terminal.

Table C.6 Control Circuit Terminal Power Supply

Input / Output	Terminal Signal	Power Supply Specifications
Multi-function digital inputs	S1, S2, S3, S4, S5, SC	Use the internal power supply of the drive. Use class 2 for external power supply.
Main frequency reference	+V, A1, AC	Use the internal power supply of the drive. Use class 2 for external power supply.

■ Drive Short-Circuit Rating

This drive has undergone the UL short-circuit test, which certifies that during a short circuit in the power supply the current flow will not rise above 30,000 amps maximum at 240 V for 200 V class drives and 480 V for 400 V class drives.

- The MCCB and breaker protection and fuse ratings shall be equal to or greater than the short-circuit tolerance of the power supply being used.
- Suitable for use on a circuit capable of delivering not more than 30,000 RMS symmetrical amperes for 240 V in 200 V class drives (up to 480 V for 400 V class drives) motor overload protection.

◆ Drive Motor Overload Protection

Set parameter E2-01 (motor rated current) to the appropriate value to enable motor overload protection. The internal motor overload protection is UL listed and in accordance with the NEC and CEC.

■ E2-01 Motor Rated Current

Setting Range: Model Dependent

Default Setting: Model Dependent

Parameter E2-01 (motor rated current) protects the motor if parameter L1-01 is not set to 0 (default is 1, standard induction motor protection enabled).

■ L1-01 Motor Overload Protection Selection

The drive has an electronic overload protection function (oL1) based on time, output current and output frequency, which protects the motor from overheating. The electronic thermal overload function is UL-recognized, so it does not require an external thermal overload relay for single motor operation.

This parameter selects the motor overload curve used according to the type of motor applied.

Table C.7 Overload Protection Settings

Setting	Description
0	Disabled
1	Std Fan Cooled (< 10:1 motor) (default setting)
2	Standard Blower Cooled (10:1 motor)

Disable the electronic overload protection (L1-01 = 0: Disabled) and wire each motor with its own motor thermal overload when connecting the drive to more than one motor for simultaneous operation.

Enable the motor overload protection (L1-01 = “1” or “2”) when connecting the drive to a single motor unless there is another means of preventing motor thermal overload. The electronic thermal overload function causes an oL1 fault, which shuts off the output of the drive and prevents additional overheating of the motor. The motor temperature is continually calculated as long as the drive is powered up.

Setting L1-01 = 1 selects a motor with limited cooling capability below rated (base) speed when running at 100% load. The oL1 function derates the motor when it is running below base speed.

Setting L1-01 = 2 selects a motor capable of cooling itself over a 10:1 speed range when running at 100% load. The oL1 function derates the motor when it is running at 1/10 or less of its rated speed.

■ L1-02 Motor Overload Protection Time

Setting Range: 0.1 to 5.0 Minutes

Factory Default: 1.0 Minutes

The L1-02 parameter sets the allowed operation time before the oL1 fault occurs when the drive is running at 60 Hz and 150% of the full load amp rating (E2-01) of the motor. Adjusting the value of L1-02 can shift the set of oL1 curves up the Y-axis of the diagram below but will not change the shape of the curves.

C.3 UL Standards

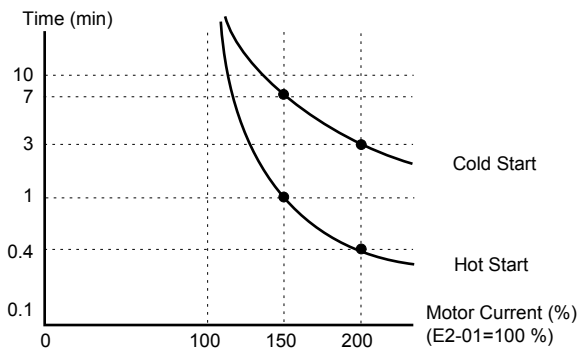

Figure C.8 Motor Overload Protection Time



Index

Numerics

2-Wire Initialization	87
2-Wire Sequence	90
3-Wire Initialization	87
3-Wire Sequence	90, 206
3-Wire Sequence Example	45

A

A/D Conversion Error	124, 126, 127
A1-01	116, 199
A1-03	87, 91, 126, 199
A1-04	116, 143, 199
A1-05	116, 143, 199
A1 Initialization Parameters	199
Accel/Decel	92
Accel/Decel Ramp Hold	206
Accel/Decel Time	122
Accel/Decel Time 1	206
Acceleration/Deceleration	91, 93
Acceleration Time 1	92, 201
Acceleration Time 2	201
Access Level Selection	116, 199
Accumulated Operation Time	109, 217
Accumulated Operation Time Selection	215
Accumulated Operation Time Setting	215
Alarms and Errors	123
Analog Filter Time Constant	122
Analog Input Filter Time Constant	209

B

Baseblock	134
Baseblock Command (N.C.)	206
Baseblock Command (N.O.)	206
Base Frequency	130, 205
Basic Operation	87
Braking Resistor	65
Braking Resistor, Installation	65
Braking Resistor Overheat	132
Buzzing Sound from Motor at 2 kHz	149

C

C1-01	83, 91, 150
C1-01, -03, -05, -07	129
C1-01 through C1-04	122
C1-02	92
C1-09	92, 201
C1 Acceleration and Deceleration Times	201
C2-01	201
C2-01 through C2-04	122, 129
C2-02	201
C2-03	201
C2-04	201
C2 S-Curve Characteristics	201
C3-01	121
C3 Slip Compensation	201
C4-01	121, 129, 131, 144
C4 Torque Compensation	202

Index

C6-01	121	CPF18	124, 127
C6-02	121, 130, 131, 147, 148, 150, 202	CPF20	124, 127
C6-03	202	CPF21	124, 127
C6-04	202	CPF22	124, 127
C6-05	148, 202	CPF23	124, 127
C6 Carrier Frequency	202	CPF24	124, 128
Cable Length Between Drive and Motor	52	CrST	125, 135
CALL	125, 134	C Tuning	201
Cannot Change Parameter Settings	143	Current Fault	109, 217
Can Not Reset	125, 135	Current Offset Fault	124, 126
Capacitor Maintenance	110, 218		
Capacitor Maintenance Setting	215	E	
Carrier Frequency Lower Limit	202	E1-01	99, 100, 204
Carrier Frequency Proportional Gain	202	E1-04	100, 140, 146, 147, 149, 205
Carrier Frequency Reduction	213	E1-04 through E1-10	129, 130, 131
Carrier Frequency Selection	121, 202	E1-05	100
Carrier Frequency Setting Error	125, 140	E1-06	100, 130, 147, 205
Carrier Frequency Upper Limit	202	E1-07	100, 140, 205
CE	124, 125, 126, 134	E1-08	100, 121, 130, 131, 144
CE mark	229	E1-09	100, 140, 144, 149, 205
Coast to Stop	91	E1-10	100, 121, 130, 131, 144, 147
CoF	124, 126	E1 V/f Pattern Characteristics	204
Comm. Fault Detection Selection	210	E2-01	106, 121, 130, 205, 238
Communication Parity Selection	209	E2-02	103, 121, 205
Communication Speed Selection	209	E2-03	103, 121, 205
Communications Test Mode	207	E2-05	103, 205
Connected Machinery Vibrates When Motor Rotates	148	E2 Motor Parameters	205
Constant Torque	101	EEPROM Data Error	126
Control Circuit Fault	124, 127	EEPROM Serial Communications Fault	124
Control Circuit Input Terminals	55	EEPROM Write Error	124, 128
Control Circuit Terminal Block Functions	55	EF	125, 135
Control Circuit Terminal Configuration	56	EF0	124, 128
Cooling Fan Maintenance	110	EF1	128, 135
Cooling Fan Maintenance Setting (Operation Time)	215	EF1 to EF5	124, 125
Cooling Fan Replacement	136	EF2	128, 135
CPF02	124, 126	EF3	128, 135
CPF06	126	EF4	128, 135
CPF08	124, 126	EF5	128, 136
CPF11	124, 127	Electrical Thermal Motor Protection	106
CPF12	124, 127	EMC Guidelines	229
CPF14	124, 127	Err.	124, 128
CPF17	124, 127	Excessive Motor Oscillation and Erratic Rotation	148
		External Fault	128, 136
		External Fault (input terminal S1 to S5)	124, 125

External Fault (user selection possible)	207	H5-07	210
External Search Command 1	207	H5-12	210
External Search Command 2	207	H5-13	210
Drive Motor Overload Protection	238	H5 MEMOBUS/Modbus Communications	209
Drive Short-Circuit Rating	238	Heatsink Cooling Fan Operation Selection	213
European Standards	18	Heatsink Temperature	110
Low Voltage Wiring	238	Heavy Duty Ratings	188
UL Standards	18	High Starting Torque	102
		Hunting Prevention Gain	121
G		Hunting Prevention Gain Setting	148, 214
General-purpose motor	107		
General Safety Information	12	I	
Ground Fault Interrupter Activates When Drive is Running	150	I/O Connections	44
Ground Wiring	52	IGBT Maintenance	110, 218
		IGBT Maintenance Setting	216
		Initialize Parameters	87, 199
		Initial Operation	86
H		Input Fuses	178, 229, 237
H1-01	84, 206	Input Phase Loss	124, 132
H1-01 through to H1-07	139	Input Phase Loss Protection Selection	213
H1-02	206	Input Terminals	84
H1-03	206	Input Terminal Status	109, 216
H1-03 through H1-07	144	Input Voltage Setting	99, 204
H1-04	206	Inrush Prevention Circuit Fault	133
H1-05	45, 97, 206	Inrush Prevention Relay Maintenance Setting	215
H1-06	97	Inspection	155, 156, 157
H1 Multi-Function Digital Input	206	Installation Environment	33
H1 Multi-Function Digital Input Selections	206	Installation Orientation	34
H2-01	103, 147, 207	Installing Multiple Drives	35
H2 Multi-Function Digital Outputs	207	Internal Dynamic Braking Resistor Protection Selection (ERF type)	213
H2 Multi-Function Digital Output Settings	208	Inverter Duty motor	107
H3-01	64, 208		
H3-01 Details	64	J	
H3-13	122, 148	Jog Frequency Reference	203
H3 Analog Inputs	208	Jog Reference Selection	206
H4-01	104, 209	Jump Frequency	122
H4-02	105	Jump Frequency 1	203
H4-03	105, 209	Jump Frequency 2	203
H4 Multi-Function Analog Outputs	209	Jump Frequency Width	204
H5-01	209		
H5-02	209	M	
H5-03	209	Magnetic Flux Compensation Capacity	200
H5-04	209	Main Circuit Connection Diagram	46, 53
H5-05	210		
H5-06	210		

Main Circuit Terminal Functions	50	Motor protection operation time	107
Main Circuit Terminal Power Supply	52	Motor Rated Current	103, 106, 205, 238
Main Circuit Terminal Wiring	27, 236	Motor Rated Slip	103, 205
Main Frequency Reference	63	Motor Rotates After the Drive Output is Shut Off ...	148
Maintenance	159, 160	Motor Rotates Faster Than the Frequency Reference	146
Master Speed Reference Lower Limit	203	Motor Rotates in One Direction Only	145
Max Output Frequency	205	Motor Stalls During Acceleration or With Large Loads	146
Max Voltage	205	Motor Stops During Acceleration or When a Load is Connected	150
MEMOBUS/Modbus Communication Error ... 124, 125, 126,	134	Motor Wiring	52
MEMOBUS/Modbus Communications Test Mode Complete	137	Multi-Function Analog 1 (Terminal AM Monitor Selection)	209
MEMOBUS/Modbus Communications Test Mode Error	137	Multi-Function Analog Outputs	104
MEMOBUS/Modbus Error Code	217	Multi-Function Contact Input	97
Memobus/Modbus Error Code	109	Multi-Function Contact Output	103
MEMOBUS/Modbus Test Mode Complete	125	Multi-Function Digital Input Terminal S1 Function Selection	206
Mid Output Frequency	205	Multi-Function Digital Input Terminal S2 Function Selection	206
Mid Output Frequency Voltage	205	Multi-Function Digital Input Terminal S3 Function Selection	206
Mid Output Voltage A	121	Multi-Function Digital Input Terminal S4 Function Selection	206
Minimum Output Frequency	149, 205	Multi-Function Digital Input Terminal S5 Function Selection	206
Minimum Output Frequency Voltage	205	Multi-Function Input Selection Error	139
Minimum Output Voltage	121	Multi-Function Input Setting Error	125
Minor Alarms	124	Multi-Step Speed Operation (4-Step Speed)	96
Minor Faults	123, 124	Multi-Step Speed Reference	206
Modes	78		
Momentary Power Loss Operation Selection	211	P	
Motor Does Not Operate When an External Run Command is Input	149	Parameter Range Setting Error	139
Motor Does Not Operate When the RUN Button on the Digital Operator is Pressed	149	Parameter Setting Range Error	125
Motor Does Not Rotate	143	Parameter Settings	82
Motor Hunting and Oscillation Control Parameters	121	PASS	125, 137
Motor Hunting Occurs When Operating With a Light Load	147	Password 1	199
Motor is Too Hot	145	Password 2	199
Motor Line-to-Line Resistance	103, 205	Password Settings	116
Motor No-Load Current	103, 205	Peak Hold Current	110, 218
Motor Overload	124, 130	Performance Life	159
Motor Overload Protection Selection	106, 210, 239	Peripheral Devices Affected by Drive Operation	150
Motor Overload Protection Time	106, 210, 239	PF	124, 132
Motor Parameters	103	Phase Order Selection	200
Motor Protection Function	130		

Preface.....	10	Software No. (Flash).....	217
Previous Fault.....	109, 217	Software No. (ROM).....	217
Programming Mode.....	78, 80, 81	Software Number (Flash).....	109
Protective Covers, Removing.....	48, 183	Software Number (ROM).....	109
PWM Feedback Data Fault.....	124	Speed Agreement Detection Level.....	212
PWM Feedback Fault.....	127	Speed Search.....	208
R		Stall Prevention.....	122
RAM Fault.....	124, 127	Stall Prevention Level during Acceleration.....	211
Ramp to Stop.....	91	Stall Prevention Level during Run.....	212
Rated Output Operation.....	102	Stall Prevention Selection during Acceleration.....	211
REMOTE.....	84	Stall Prevention Selection during Deceleration.....	211
Replacement Parts.....	159, 195	Stall Prevention Selection during Run.....	211
Restart Enabled.....	208	Standard Connection Diagram.....	43, 44
Reverse Direction.....	208	STOP Key Function Selection.....	214
Reverse Operation Selection.....	200	Stopping Method.....	91
Reverse Run Command (2-Wire sequence).....	207	Stopping Method After Communication Error.....	209
RTS Control Selection.....	210	Stopping Method Selection.....	200
Run command.....	92	T	
Run Command at Power Up.....	200	Terminal A1 Bias Setting.....	208
Run Command Input Error.....	125	Terminal A1 Gain Setting.....	208
Run Command Input Selection.....	89	Terminal A1 Input Voltage.....	109
Run Command Selection.....	143, 199	Terminal A1 Signal Level Selection.....	208
Run Command Selection during Program.....	200	Terminal Block Configuration.....	47
Run Command Selection Error.....	125, 140	Terminal M1 thru M2 Function Selection (relay).....	103
S		Terminal MA, MB and MC Function Selection (relay)	103, 207
S1.....	90	Test Run.....	114
S2.....	90	Tightening Torque.....	50
Safety Hazard Definitions.....	12	Timing Fault.....	124, 127
Safety Information.....	12	Torque Compensation Gain.....	121, 202
S-Curve Characteristic at Accel End.....	201	Torque Detection 1 (N.O.).....	208
S-Curve Characteristic at Accel Start.....	201	Torque Detection 2 (N.O.).....	208
S-Curve Characteristic at Decel End.....	201	Torque Detection Level 1.....	212
S-Curve Characteristic at Decel Start.....	201	Torque Detection Selection 1.....	212
S-Curve Characteristics.....	93, 122	Torque Detection Time 1.....	212
SE.....	125, 137	Transistor Input Signal.....	61, 62
Serial Communication Transmission Error.....	125, 134	U	
Setup Mode.....	80, 85	U1-01.....	109, 144, 146, 216
Sinking/Sourcing Mode Switch.....	27	U1-02.....	109, 216
Slip Compensation Gain.....	201	U1-03.....	109, 216
Slip Compensation Primary Delay Time.....	201	U1-06.....	109, 216
Soft Charge Circuit Fault.....	124	U1-07.....	109, 143, 216
Soft CLA Selection.....	213		

Index

U1-09.....	144
U1-10.....	109, 216
U1-11.....	109, 217
U1-13.....	109, 217
U1-19.....	109, 217
U1-25.....	109, 217
U1-26.....	109, 217
U1 Operation Status Monitors	216
U2-01.....	109, 217
U2-02.....	109, 141, 217
U2 Fault Trace	217
U2 Initial Value Selection	216
U4: Maintenance Monitors	217
U4-01.....	109, 217
U4-04.....	110, 217
U4-05.....	110, 132, 133, 138, 218
U4-06.....	133, 218
U4-07.....	110, 218
U4-08.....	110, 218
U4-09.....	110, 218
U4-13.....	110, 218
U Monitors.....	216
Undervoltage	124, 125, 137
Undervoltage 3	133
Unexpected Noise from Connected Machinery	148
Up Command	207
User Monitor Selection After Power Up	214
Uv.....	125, 137
Uv1	124, 133
Uv3	124, 133
V	
V/f Data Setting Error	125, 140
V/f Pattern	100
Verify Menu	80
W	
Wire Gauges	50
Wiring Procedure	57
Z	
Zero Speed	208

Revision History

The revision dates and numbers of the revised manuals are given on the bottom of the back cover.

MANUAL NO. TOEP C710606 25B

Published in Japan March 2008 08-1 

└─ Date of publication

└─ Date of original publication

└─ Revision number

Date of Publication	Rev. No.	Section	Revised Content
January 2008	–	–	First edition
March 2008		All Chapters	General revision

YASKAWA AC Drive J1000

Compact V/f Control Drive

Installation & Start-Up Manual

IRUMA BUSINESS CENTER (SOLUTION CENTER)

480, Kamifujisawa, Iruma, Saitama 358-8555, Japan
Phone 81-4-2962-5696 Fax 81-4-2962-6138

YASKAWA ELECTRIC AMERICA, INC.

2121 Norman Drive South, Waukegan, IL 60085, U.S.A.
Phone 1-847-887-7000 Fax 1-847-887-7370

YASKAWA ELÉTRICO DO BRASIL LTDA.

Avenida Fagundes Filho, 620 São Paulo-SP CEP 04304-000, Brazil
Phone 55-11-3585-1100 Fax 55-11-5581-8795

YASKAWA ELECTRIC EUROPE GmbH

Am Kronberger Hang 2, 65824 Schwalbach, Germany
Phone 49-6196-569-300 Fax 49-6196-569-312

YASKAWA ELECTRIC UK LTD.

1 Hunt Hill Orchardton Woods Cumbernauld, G68 9LF, United Kingdom
Phone 44-1236-735000 Fax 44-1236-458182

YASKAWA ELECTRIC KOREA CORPORATION

7F, Doore Bldg. 24, Yeoido-dong, Youngdungpo-Ku, Seoul 150-877, Korea
Phone 82-2-784-7844 Fax 82-2-784-8495

YASKAWA ELECTRIC (SINGAPORE) PTE. LTD.

151 Lorong Chuan, #04-01, New Tech Park 556741, Singapore
Phone 65-6282-3003 Fax 65-6289-3003

YASKAWA ELECTRIC (SHANGHAI) CO., LTD.

No.18 Xizang Zhong Road, Room 1702-1707, Harbour Ring Plaza Shanghai 200001, China
Phone 86-21-5385-2200 Fax 86-21-5385-3299

YASKAWA ELECTRIC (SHANGHAI) CO., LTD. BEIJING OFFICE

Room 1011A, Tower W3 Oriental Plaza, No.1 East Chang An Ave.,
Dong Cheng District, Beijing 100738, China
Phone 86-10-8518-4086 Fax 86-10-8518-4082

YASKAWA ELECTRIC TAIWAN CORPORATION

9F, 16, Nanking E. Rd., Sec. 3, Taipei, Taiwan
Phone 886-2-2502-5003 Fax 886-2-2505-1280



YASKAWA

YASKAWA ELECTRIC CORPORATION

In the event that the end user of this product is to be the military and said product is to be employed in any weapons systems or the manufacture thereof, the export will fall under the relevant regulations as stipulated in the Foreign Exchange and Foreign Trade Regulations. Therefore, be sure to follow all procedures and submit all relevant documentation according to any and all rules, regulations and laws that may apply.

Specifications are subject to change without notice for ongoing product modifications and improvements.

© 2008 YASKAWA ELECTRIC CORPORATION. All rights reserved.



TOEP071060625

MANUAL NO. TOEP C710606 25B

Published in Japan March 2008 08-1 ◇-0
07-11-2