

ASSEMBLY AND INSTALLATION

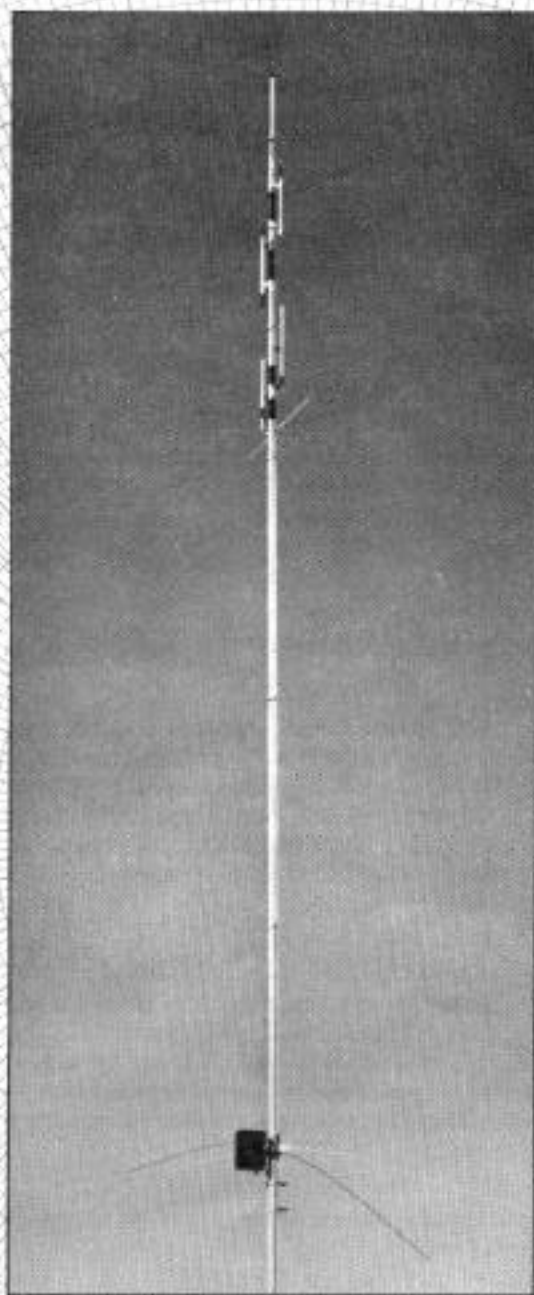

R5

10, 12, 15, 17, 20 METERS



951361 (10/89)

WARNING

THIS ANTENNA IS AN ELECTRICAL CONDUCTOR. CONTACT WITH POWER LINES CAN RESULT IN DEATH OR SERIOUS INJURY. DO NOT INSTALL THIS ANTENNA WHERE THERE IS ANY POSSIBILITY OF CONTACT WITH OR HIGH VOLTAGE ARC-OVER FROM POWER CABLES OR SERVICE DROPS TO BUILDINGS. THE ANTENNA, SUPPORTING MAST AND/OR TOWER MUST NOT BE CLOSE TO ANY POWER LINES DURING INSTALLATION REMOVAL OR IN THE EVENT PART OF THE SYSTEM SHOULD ACCIDENTLY FALL. FOLLOW THE GUIDELINES FOR ANTENNA INSTALLATIONS RECOMMENDED BY THE U.S. CONSUMER PRODUCT SAFETY COMMISSION AND LISTED IN THE ENCLOSED PAMPHLET.

Your Cushcraft R5 vertical antenna is designed and manufactured to give trouble free service. The antenna will perform as specified if the instructions and suggestions are followed and care is used in assembly and installation. When checking the components received in you antenna package use the parts list on page 8. Parts are also listed beside each diagram. If you are unable to locate any tube or component, check the inside of all tubing. **IMPORTANT:** Save the weight label from the outside of the carton. Each antenna is weighed at the factory to verify the parts count. If you claim a missing part, you will be asked for the weight verification label.

PLANNING

Plan your installation carefully. If you use volunteer helpers be sure that they are qualified to assist you. Make certain everyone involved understands that you are the boss and that they must follow your instructions. If you have any doubts at all, employ a professional antenna installation company to install your antenna.

LOCATION

Extreme care must be used for your safety. Although the R5 will operate in almost any location, it will perform best if it is in the clear. Surrounding objects such as trees, power lines, other antennas, etc., will reduce its efficiency. Mount the antenna as high and in the clear as possible.

Your R5 is a half wavelength vertical which does not require traditional ground radials. Your roof top, balcony, garden, motor home, porch, deck, or tower top etc, are all suitable locations for the R5. Do not install the R5 over or in close proximity to a ground radial system since it may detune the antenna. **YOU MUST INSURE THAT NEITHER PEOPLE OR PETS CAN COME IN CONTACT WITH YOUR ANTENNA WHILE IT IS IN OPERATION. DEADLY VOLTAGES AND CURRENTS MAY EXIST. ALSO, SINCE THE EFFECTS OF EXPOSURE TO RF ARE NOT FULLY UNDERSTOOD, LONG TERM EXPOSURE TO INTENSE RF FIELDS IS NOT RECOMMENDED. THERE ARE FOUR WARNING STICKERS WHICH MUST BE ATTACHED TO THE COUNTERPOISE GROUND RADIALS AS SHOWN IN FIGURE 2.**

SYSTEM GROUNDING

Direct grounding of the antenna, mast, and tower is very important. This serves as protection from lightning-strikes and static buildup, and from high voltage which is present in the radio equipment connected to the antenna. A good electrical connection should be made to one or more ground rods (or other extensive ground system) directly at the base of the tower or mast, using at least 10AWG ground wire and non-corrosive hardware. For details and safety standards, consult the National Electrical Code. You should also use a coaxial lightning arrester. Cushcraft offers several different models, such as the LAC-1, LAC-2 or the LAC-4 series.

ASSEMBLY

Assemble the antenna by following steps 1 through 6. After assembly, adjust the antenna, if necessary, by following the procedures in next paragraph.





ADJUSTMENT

The dimensions shown in figure 4 normally allow proper operation on all bands. The following procedures compensate for variations from one installation to another. Adjustments should be made to the R5 beginning with the section between the base and the first trap. This controls 10 meter operation. Attach a good quality VSWR bridge in the coaxial cable as close to the antenna as possible. Measure the VSWR across the 10 meter band. If the lowest readings are not near your favorite frequencies the following adjustments may be made. If the frequency of the lowest VSWR is too high then lengthen dimension A by 1 inch (2.54 cm), (figure 4). This will lower the operating frequency. If you would like to raise the frequency of 10 meters, dimension A should be shortened. Check the VSWR to see if the lowest reading is on the proper frequency. If it is satisfactory you may use this procedure to adjust dimension B for 15 meters, C for 17 meters and dimension D for 20 meters. The antenna does not need to be adjusted for 12 meter operation. When the antenna is completely assembled and tuned check all fasteners to be sure that they are tight.

INSTALLATION

Following the guidelines in the LOCATION paragraph, place your antenna in its operating location. The base section will conveniently fit over a 1 7/8" (4.8 cm) OD or smaller tube. Now connect your feedline to the R5. Run the feedline to your operating position. Attach the feedline to your transceiver. If you plan to install the antenna in a salty or corrosive environment, you may want to consider coating it with a clear marine varnish or equivalent after assembly.

ROD BRACKET ASSEMBLY

KEY	P/N		DESC	SIZE	QTY
10	010010		LOCK WASHER	#8	12
11	010011		HEX NUT	8-32	12
79	010079		MACHINE SCREW	8-32 x 1/2" (1.27 cm)	12
96	202296		ROD BRACKET		4

#1-ASSEMBLE GROUND ROD BRACKETS

Using figure 1 assemble the rod brackets. First assemble two rod brackets leaving the screws and nuts loose. Now assemble a second set of these brackets. Attach the two halves loosely around the base insulator.

FIGURE 1
ROD BRACKET ASSEMBLY

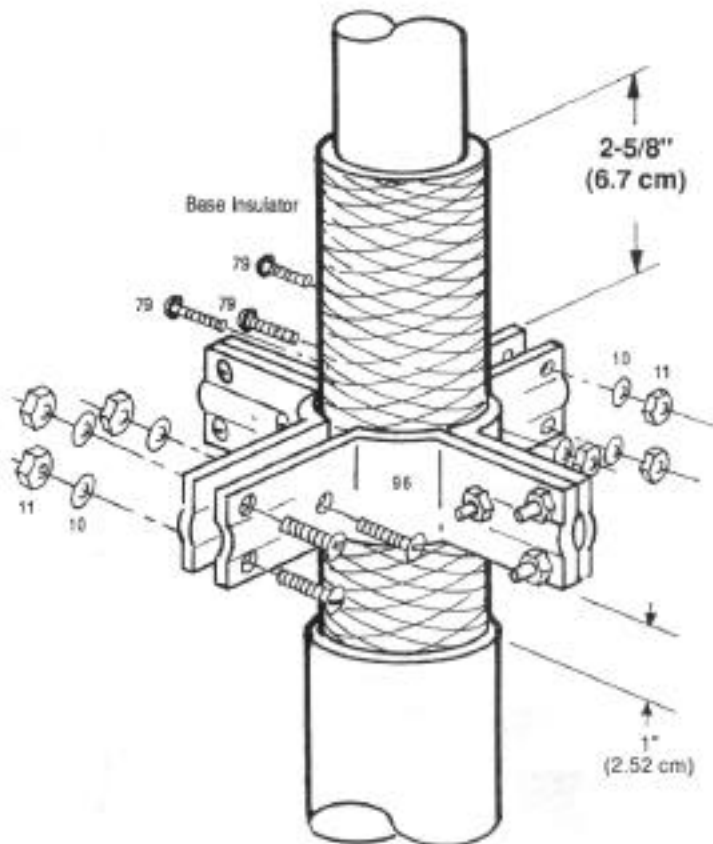

BASE ASSEMBLY PARTS

















KEY	P/N		DESC	SIZE	QTY
83	010083		MACHINE SCREW	1/4-20 x 1-1/4" (3.2 cm)	2
84	010084		LOCK WASHER	1/4" (.6 cm)	2
85	010085		HEX NUT	1/4-20	2
90	200090		MAST MT. RING		2
96	202296		ROD BRACKET		4
294	192294		JUMPER STRAP		1
79	010079		MACHINE SCREW	8-32 x 1/2" (1.27 cm)	12
10	010010		LOCK WASHER	#8	15
11	010011		HEX NUT	8-32	15
233	010233		LOCK WASHER	#10	1
220	010220		HEX NUT	10-24	1
186	221186		IG ROD	.1" x 48" (.25 x 122 cm)	4
326	290326		WARNING LABEL		4
116	240116		SILICONE PACKET		1
115	050115		CONNECTOR BOOT		1
MN-5			IMPEDANCE MATCHING ASSEMBLY		1

FIGURE 3A
MAST MOUNT RING

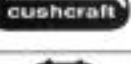

#2 - ASSEMBLE BASE

Referring to figure 2, attach the Impedance Matching Box (MN-5) to the radiator bracket as shown. To do this you may have to rotate the radial rod bracket assembly slightly if it is in the way. Holding the box with the pre-attached bracket on the bottom and next to the mast mount tube, lift the box so the mounting bolts on the top of the box go through the holes in the upper mounting bracket. Attach the bottom of the box to the protruding screw (figure 3). Attach braid 294 between the box and the rod brackets as shown. Next assemble and position the mast mount rings (90). Be sure the locking screws in the mast mount ring go through the pre-drilled holes in the R5 base (figure 3A). The IG rods should be attached later during step 5.

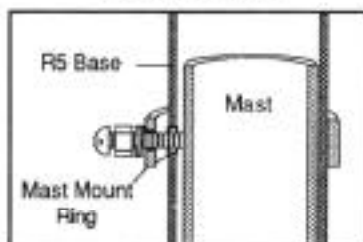
FIGURE 2
BASE ASSEMBLY

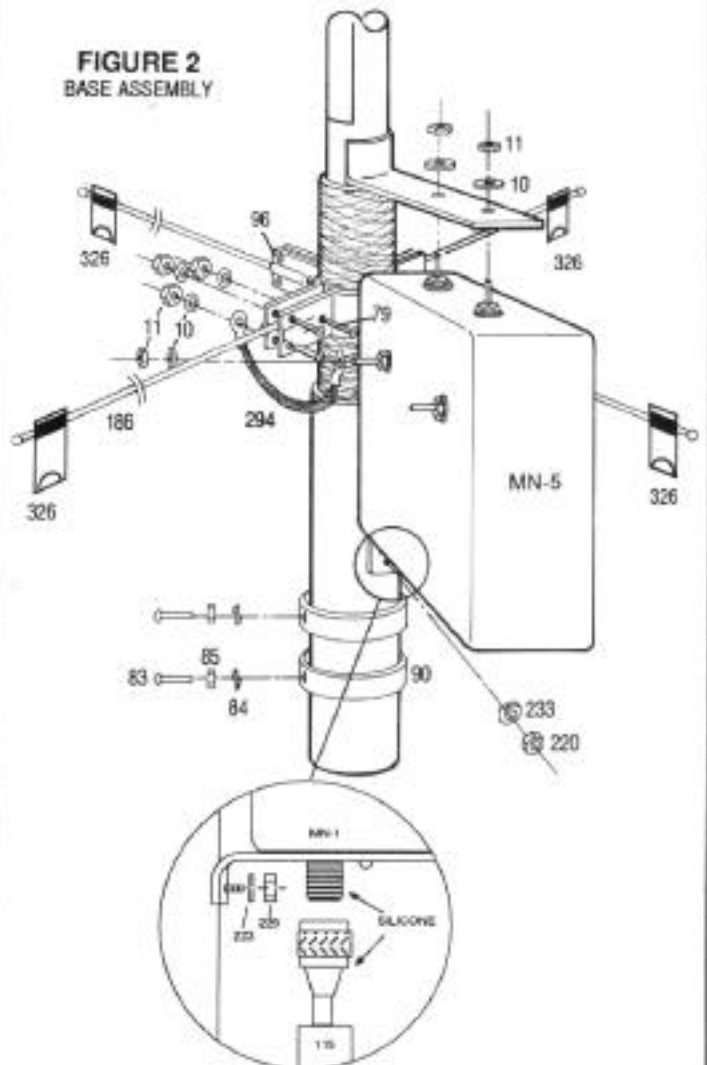















FIGURE 3
FEEDLINE CONNECTION

Oversized connector hole at base of black box is for moisture drainage.

VERTICAL ASSEMBLY PARTS

KEY	P/N		DESC	SIZE	QTY
409	030409		WORM CLAMP	7/8" (2.22 cm)	1
410	030410		WORM CLAMP	1" (2.54 cm)	3
411	030411		WORM CLAMP	1 1/4" (3.2 cm)	1
412	030412		WORM CLAMP	1 1/2" (3.8 cm)	2
53	050053		PLASTIC CAP	1/2" (1.27 cm)	1
AF			ALUM TUBING	1/2 x 16" (1.3 X 40.5 cm)	1
AC			ALUM TUBING	1 1/8 x 48" (2.9 x 122 cm)	1
AB			ALUM TUBING	1 1/4 x 48" (3.2 x 122 cm)	1
AA			BASE SECTION	48" (122 cm)	1
TW			10 & 12 M TRAP		1
TR1			15 M TRAP		1
TR2			17 M TRAP		1
CS			ALUM TUBING	1" x 3-1/2" (2.54 X 8.9 cm)	1

#3

ASSEMBLE VERTICAL

When the base section assembly is completed, place worm clamp (412) over the top of the base tube (AA). Insert tube AB in 4 inches (10 cm) and tighten the clamp. Continue the same procedure with AC. Note the measurement points shown in figure 4 and then attach trap assemblies TW, TR1 and TR2. The arrows that are on the labels affixed to the traps must point up for assembly. The external trap capacitors should alternate from left to right as you assemble the antenna. Install tube AF with clamp 409 as shown. Use care in setting the radiator dimensions as shown on the drawing.

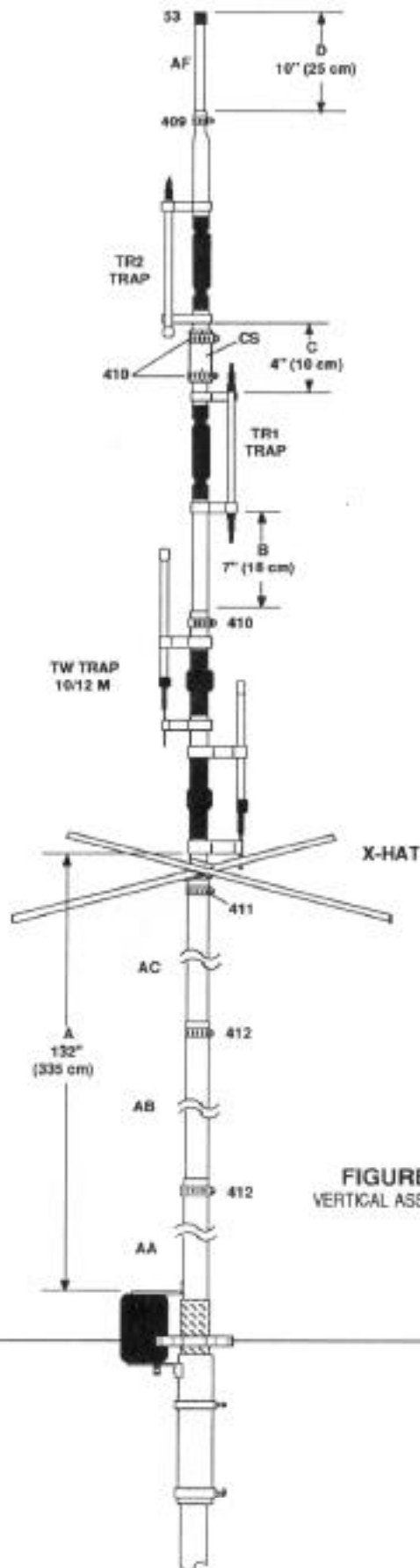







FIGURE 4
VERTICAL ASSEMBLY

KEY	P/N		DESC	SIZE	QTY
26	190026		FORMED BRACKET	7/8" (2.2 cm)	2
XHR			X-HAT ROD	3/16 x 36" (.5 x 91.4 cm)	2
231	010231		MACHINE SCREW	8-32 x 1 3/4" (4.4 cm)	2
10	010010		LOCK WASHER	#8	2
11	010011		HEX NUT	8-32	2
28	190028		ALUM HALF WASHER		2

#4 - ASSEMBLE X-HAT

Assemble and attach the X-hat to trap TW as shown in figure 5.

FIGURE 5
X-HAT ASSEMBLY

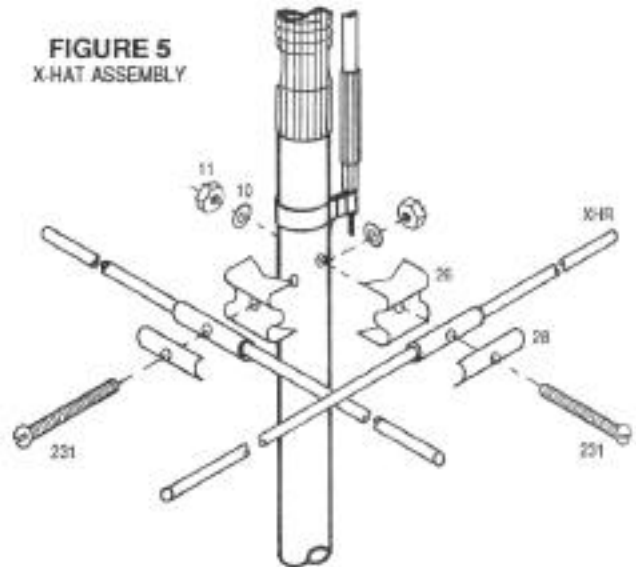

#5 - ATTACH IG RODS

Attach the 48 inch (122 cm) IG rods to the rod bracket on the antenna base. Slip them into the slots on the end of the bracket and firmly tighten the machine screws and nuts (figures 1 and 2). Attach warning labels 326 to the ends of the IG rods as shown in figure 2.

#6 - FEEDLINE

We have provided a weatherproof boot for the PL-259 connector on your feedline. Follow figure 3 on page 3 to install it. Insert the antenna end of you coax through the small end of your connector boot. Many cables are very tight which results in an excellent weather seal. Attach the PL-259 to the end of your coax. Spread the silicone on the threads of the antenna connector. Silicone should not be spread on the center pin. Apply the remaining silicone to the outside of the connector. Slip the boot over the connector, until it touches the bracket.

SPECIFICATIONS

Frequency Meters	10, 12, 15, 17, 20
Electrical Wavelength	
Each band	Half-wave
VSWR 1.2:1 Typical	
2:1 Bandwidth	10m (2.0-1.7 MHz), 12m (100 KHz), 15m (400 KHz), 17m (100 KHz), 20m (300 KHz)
Power Rating, Watts PEP	1500
Radiation Angle Typical	At Horizon
Frequency Selection	Automatic
Horizontal Radiation Pattern Degrees	360°
Height, ft. (m)	17' (5.2)
Mast Size Range, in. (cm)	1.5-1.75 (3.8-4.4)
Wind Load, ft ² (m ²)	1.4 (.13)
Weight, lb. (kg)	8.7 (4)

TYPICAL VSWR CURVES

10 METERS

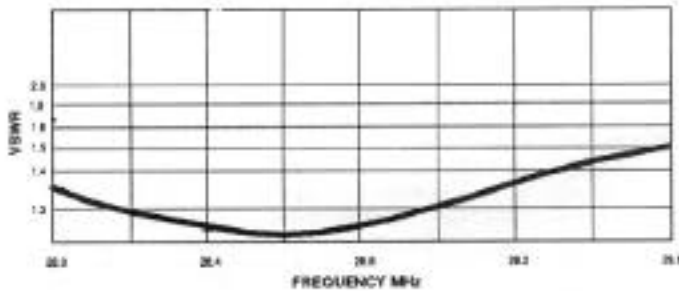

12 METERS

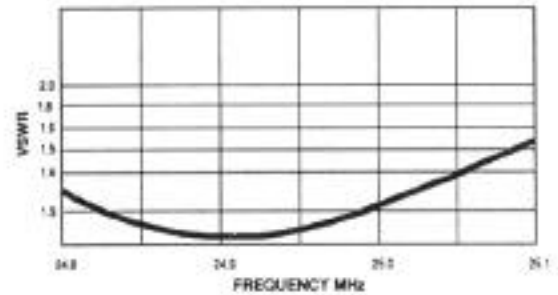

15 METERS

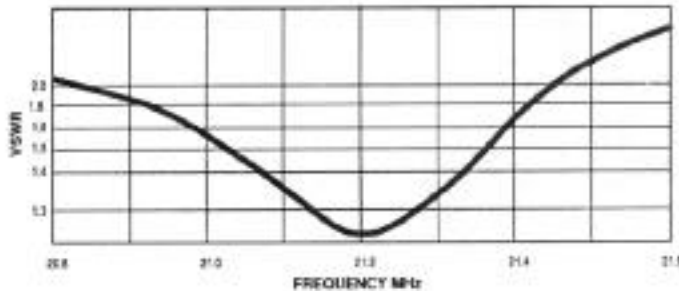

17 METERS

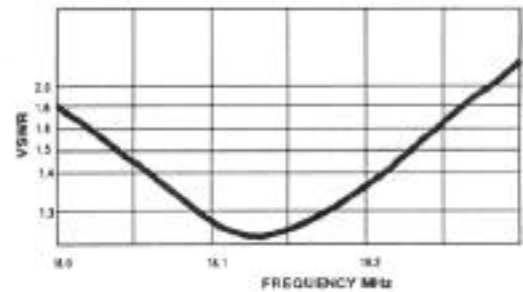

20 METERS

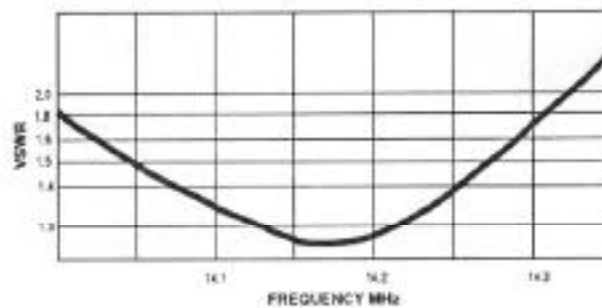

MASTER PARTS LIST

KEY	P/N	DESCRIPTION	QTY	KEY	P/N	DESCRIPTION	QTY
AA		Base Section Assembly, 1-3/8" x 48" (2.8 x 121.9 cm)	1	84	010084	1/4" (.63 cm) stainless steel split lock washer	2
AB		1-1/4" x 48" (3.2 x 121.9 cm) aluminum tube slotted one end	1	85	010085	1/4-20 stainless steel hex nut	2
AC		1-1/8" x 48" (2.8 x 121.9 cm) aluminum tube slotted one end	1	220	010220	10-24 stainless steel hex nut	1
AF		1/2" x 16" (1.27 x 40.6 cm) aluminum tube	1	231	010231	8-32 x 1-3/4" (4.44 cm) stainless steel machine screw	2
XHR		3/16" x 36" (.4 x 91.4 cm) aluminum rod with #18 hole drilled mid point	2	233	010233	#10 stainless steel split lock washer	1
CS		1" x 3-1/2" (2.54 x 8.9 cm) aluminum tube	1	409	030409	7/8" (2.22 cm) stainless steel worm clamp	1
186	221186	0.100" x 48" (.25 x 121.9 cm) stainless steel rod with ball tip one end	4	410	030410	1" (2.54 cm) stainless steel worm clamp	3
TW		10-12 meter Trap Assembly 30" (76 cm)	1	411	030411	1-1/4" (3.17 cm) stainless steel worm clamp	1
TR1		15 meter Trap Assembly 20" (51 cm)	1	412	030412	1-1/2" (3.81 cm) stainless steel worm clamp	2
TR2		17 meter Trap Assembly 18-1/4" (46.3 cm)	1	115	050115	Vinyl connector boot	1
MN-5		Impedance Matching Box Assembly	1	53	050053	1/2" (1.27 cm) black plastic cap	1
79	010079	8-32 x 1/2" (1.27 cm) stainless steel machine screw	12	26	190026	7/8" (2.22 cm) formed aluminum bracket with #8 hole	2
10	010010	#8 internal tooth lock washer	17	28	190028	Aluminum half washer	2
11	010011	8-32 stainless steel hex nut	17	96	202296	7/8" x 3-3/4" (2.22 x 9.52 cm) radial clamp	4
83	010083	1/4-20 x 1-1/4" (3.2 cm) stainless steel machine screw	2	90	200090	Mast mounting ring	2
				116	240116	Silicone grease packet	1
				326	290326	Warning label	4
				294	102294	Jumper Strap	1

LIMITED WARRANTY

Cushcraft Corporation, P.O. Box 4680, Manchester, New Hampshire 03108, warrants to the original consumer purchaser for one year from date of purchase that each Cushcraft antenna is free of defects in material or workmanship. If, in the judgement of Cushcraft, any such antenna is defective, then Cushcraft Corporation will, at its option, repair or replace the antenna at its expense within thirty days of the date the antenna is returned (at purchasers expense) to Cushcraft or one of its authorized representatives. This warranty is in lieu of all other expressed warranties, any implied warranty is limited in duration to one year. Cushcraft Corporation shall not be liable for any incidental or consequential damages which may result from a defect. Some states do not allow limitations on how long an implied warranty lasts or exclusions or limitations of incidental or consequential damages, so the above limitation and exclusion may not apply to you. This warranty gives you specific legal rights, and you may also have other rights which vary from state to state. This warranty does not extend to any products which have been subject to misuse, neglect, accident or improper installation. Any repairs or alterations outside of the Cushcraft factory will nullify this warranty.



48 PERIMETER ROAD, MANCHESTER, NH 03108
603-627-7877 / TELEX 4949472 / FAX 603-627-1764

SPECIFICATIONS SUBJECT TO CHANGE WITHOUT NOTICE